

**AT** MICROFICHE  
REFERENCE  
LIBRARY

A project of Volunteers in Asia

Rural Roads Manual

Published by:  
Department of Works and Supply  
P.O. Box 1108  
Boroko  
Papua New Guinea

Paper copies are \$4; free in exchange for your publications.

Available from:  
Department of Works and Supply  
P.O. Box 1108  
Boroko  
Papua New Guinea

Reproduced by permission of the Department of Works and Supply, Papua New Guinea.

Reproduction of this microfiche document in any form is subject to the same restrictions as those of the original document.



DEPARTMENT OF PUBLIC WORKS

SELF-HELP AND RURAL IMPROVEMENT  
ROADS

**CONSTRUCTION MANUAL**  
**(1976 EDITION)**

ADVISORY SERVICE TO LOCAL GOVERNMENT  
COUNCILS

PUBLIC WORKS DEPARTMENT  
LOCAL GOVERNMENT ADVISORY SERVICE

RURAL ROADS MANUAL  
SIMPLE ENGLISH VERSION

A CONSTRUCTION AND MAINTENANCE BOOK FOR OVERSEERS  
OF RURAL IMPROVEMENT OR LOCAL GOVERNMENT COUNCIL ROADS.

THIS BOOK USES METRIC MEASURES.

WHAT YOU WILL FIND IN THIS BOOK:

SECTION 1: FIRST WORDS

Page 1

SECTION 2: GENERAL TALK

Page 5

A. Gradient

Page 6

B. Drainage

Page 7

C. Surfacing Material

Page 13

D. Formation of the Road

Page 16

E. Horizontal Alignment

Page 16

F. Summary

Page 18

SECTION 3: SURVEYING A ROAD

Page 19

A. Different sorts of surveys

Page 21

1. A survey for a road that is already built

Page 21

2. A survey for a new road

Page 21

3. A survey for a road for an area that is  
very steep and broken

Page 22

4. A survey for a hairpin bend

Page 23

B. The Surveyor's Field Book

Page 23

C. Four important points about survey

Page 24

SECTION 4: MARKING THE PLACE WHERE THE ROAD WILL GO

Page 26

A. How do you mark the route permanently?

Page 26

B. How big must you make the track?

Page 27

C. How do you make a benched road track?

Page 28

D. Making a good even gradient with boning rods

Page 29

E. Using a gradient template

Page 30

SECTION 5: BEGINNING TO MAKE THE ROAD

Page 33

A. How to make a bench-cut road

Page 34

1. Clearing the bush

Page 34

2. Cutting the bench

Page 35

3. Camber and Drainage

Page 41

4. Batter

Page 45

5. Hairpin bends

Page 46

B. How to construct a road on flat country or  
country that is nearly flat

Page 48

1. Clearing the bush

Page 48

2. Clearing the topsoil

Page 49

3. Formation of the road - camber

Page 51

# FÖREWORD TO THE SIMPLE ENGLISH

## EDITION OF THE ROAD CONSTRUCTION MANUAL

Exactly three years ago the Local Government Engineer of the Department of Public Works produced a comprehensive Manual dealing with the construction and maintenance of Rural Roads. It was issued to the Councils. They read it and asked for more copies. The success of the book made us very happy. Knowing that we have many keen students of our book, we decided to improve on our work. Readers brought to our attention shortcomings of the first edition, making it possible to make improvements. At the same time the localisation of Council Advisors and the knowledge of technical English by Council staff made it apparent to us that while broadening the technical contents of the book, we should also attempt to remove less known technical words and replace them with every day English. Mrs. Rock, the wife of our Local Government Engineer, being a highly qualified teaching expert, came to our assistance. Painstakingly she went sentence by sentence, paragraph by paragraph and turned all the technical paragraphs into correct but non-technical sentences. The result of this excellent work is offered now back to the Councils as the Second Edition of our original Manual.

I am proud to be associated with this book and hope that readers in the far distant areas of our country, far from assistance and advice of professional engineers and experienced road foremen, will be able with the help of this book, get most of the answers they may be looking for in solving the never ending problems of road builders. At the same time I invite all readers to send any constructive criticism and advice they may have so, that if needed, we may be able in time to issue a third edition of the same book brought up to date at some future date.

Good luck.



E. ROBIN SAFITUA

Director of Department of Public Works

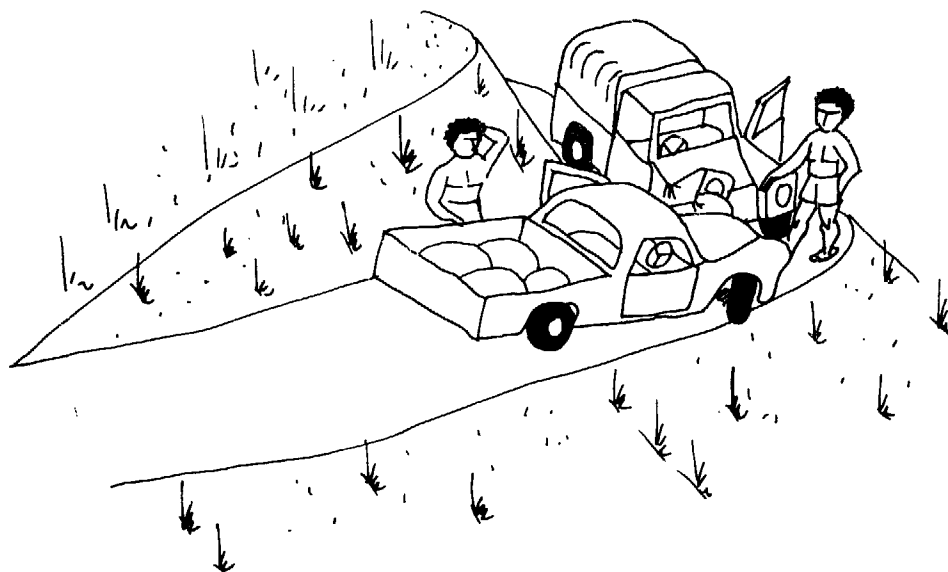

For these reasons, Councils and the people should not try to build too much new road at one time. It is better to build a few kilometres properly, than to try too much and do it badly. Bad roads should be improved in small sections. These are not too hard to get finished. When the old roads have been fixed, new ones can be added to them each year.

Do not waste money. Ask the Local Government Engineer.

It costs a lot of money to improve a road and build permanent bridges and culverts.

If these things are not done the right way, the improvements will not be very good and the money will be wasted. A good council does not want to waste its money or the Rural Improvement money that the Government gives.

Two things will help a Council not to waste money: First, roads should be built in the fashion this Construction Manual talks about. Secondly, a Council can get help from Local Government Engineering field staff in its own District, or write to the

Director,  
Department of Public Works,  
P.O. Box 1108,  
BOROKO.

making the letter "Attention : Local Government Engineer", and ask for technical help. The Local Government Engineer can send surveyors, men who will measure high hills, and who will tell the Council the best place to build a road on a high hill.

A. Culverts	Page 90
1. What sort of pipe?	Page 90
2. How big should a culvert be?	Page 90
3. How deep should you put the pipe?	Page 94
4. How to prepare a bed for the pipe?	Page 95
5. How do you lay the pipe?	Page 96
6. How do you back-fill a trench round the pipe?	Page 97
7. Headwalls	Page 100
8. Aprons	Page 102
B. Timber Bridges	Page 104
1. First words	Page 104
2. What timber do you need?	Page 104
3. How high should a bridge be?	Page 105
4. How do you measure the log?	Page 106
5. How do you prevent rot?	Page 106
6. How high should the bridge be?	Page 106
7. Abutments	Page 108
8. Stringers and Decking	Page 114
9. Kerbing	Page 116
10. Guide posts	Page 117
11. General information about log bridges	Page 117
12. Summary	Page 118
C. Low-level crossings	Page 120
1. What is a good place for a crossing?	Page 120
2. What materials do you need?	Page 120
3. How to build a ford	Page 122
4. Causeways	Page 124
5. Girder bridges	Page 125
6. Lattice bridges	Page 126
7. Bailey bridges	Page 126
8. Suspension bridges	Page 127
9. Cable swing bridges	Page 127
10. Need for survey and design	Page 128

Many roads in Papua New Guinea are not good enough

All round Papua New Guinea there are plenty of roads that have been built by village people. A lot of these roads are no good and others can only be used some of the time. Many months of work, and much of the money of the Government, Councils and people have been wasted on roads not built properly.

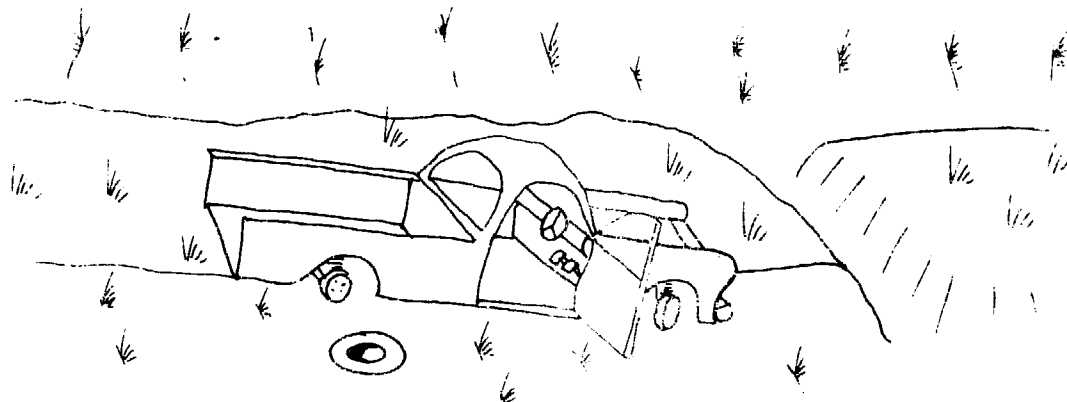

This has often happened because the people building the roads did not know the right way to do the work. The other big trouble has been that there were not enough skilled men, or supervisors, to show the people what to do and stop mistakes from being made. This book, called a Construction Manual, has been written because the Government wants to try to help the people build better roads, and to talk about things that can go wrong when roads are being built.

As well as the need to save money and work from being wasted, there are other reasons why self-help roads should be built better.

Good roads do not need a lot of maintenance.

The first reason is maintenance. When we talk about "maintenance" in road work, the word means work that is done and money spent to fix up a road or bridge when it has been worn or damaged, either from being used or by too much rain. Section 7 of this book is about maintenance. You can read about it on pages 81 to 89. Some money is being given by the Government to help Councils maintain their roads, but Councils will have to help too with their own money and work. There will always be a shortage of money for this work, but roads built properly, the way this book says, will not cost as much to maintain as roads built badly. Bad roads on steep slopes will cost a lot more to keep in use than roads that were well made in the first place.

Good roads are safer

Also, a well-built road is safer than a badly built one, and people are not so likely to get hurt in accidents, or have their cars and trucks damaged, broken or stuck.



4. Formation of the road - side drains	Page 52
5. Formation of the road - relief drains	Page 53
6. Why do all roads need drainage?	Page 54
C. How to build a road in swampy country	Page 54
1. Roads in swampy country are hard	Page 54
2. What is ground-water-level?	Page 54
3. How to construct an embankment	Page 55
4. Camber on an embankment road	Page 59
5. What can you use to make a road stable?	Page 59
6. What to do when you have trouble	Page 59
D. Other information about how to make a new road	Page 59
1. Vertical alignment	Page 59
2. Horizontal alignment	Page 61
3. Temporary culverts and bridges	Page 61
4. Side drains	Page 62
5. Filling	Page 63
6. Surfacing	Page 67
7. Removing solid rock	Page 70
8. Razor-back ridges	Page 70
9. When can trucks use the road?	Page 73
10. What to do with the workmen	Page 73
11. Summary - a list of important things	Page 74

<u>SECTION 6: UPGRADING A ROAD</u>	Page 75
A. Why do you upgrade a road?	Page 75
B. Upgrading an old road	Page 75
C. Very steep country	Page 76
D. New culverts	Page 77
E. Improving the Line and Grade	Page 77
F. Improving curves - Super-elevation	Page 78
G. You must make new drains when you upgrade	Page 80

<u>SECTION 7: MAINTAINING A ROAD</u>	Page 81
A. Need for maintenance	Page 81
B. Things that go wrong	Page 81
1. Potholes	Page 81
2. Loss of surfacing material	Page 81
3. Loss of camber	Page 82
C. Other maintenance jobs	Page 83
D. Road gangs on sections	Page 84
E. Government help for Council road maintenance	Page 84
F. Minor roads	Page 89

The Local Government Engineer can also send engineers, men who plan bridges and causeways that will go over rivers.

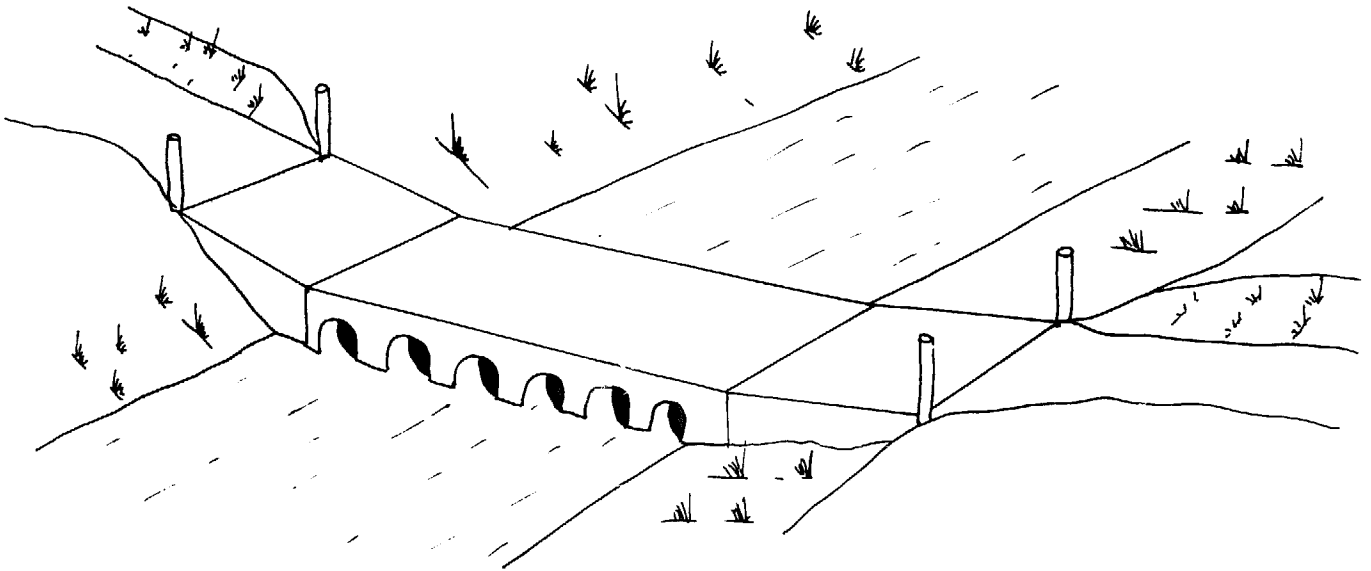

The Council does not have to pay these men for their help. The Local Government Engineer sends them out to help Councils build roads that are being built with Rural Improvement Fund money.

If you want technical help from surveyors and engineers for a job that is not paid for by Rural Improvement Fund money, you will have to wait a while.

It is not good for Papua New Guinea to have bad roads.

Councils can construct new roads.

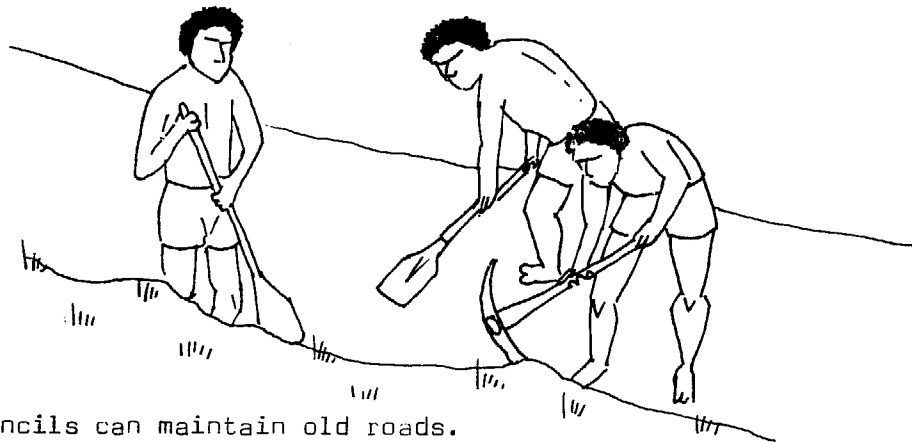

Councils can maintain old roads.

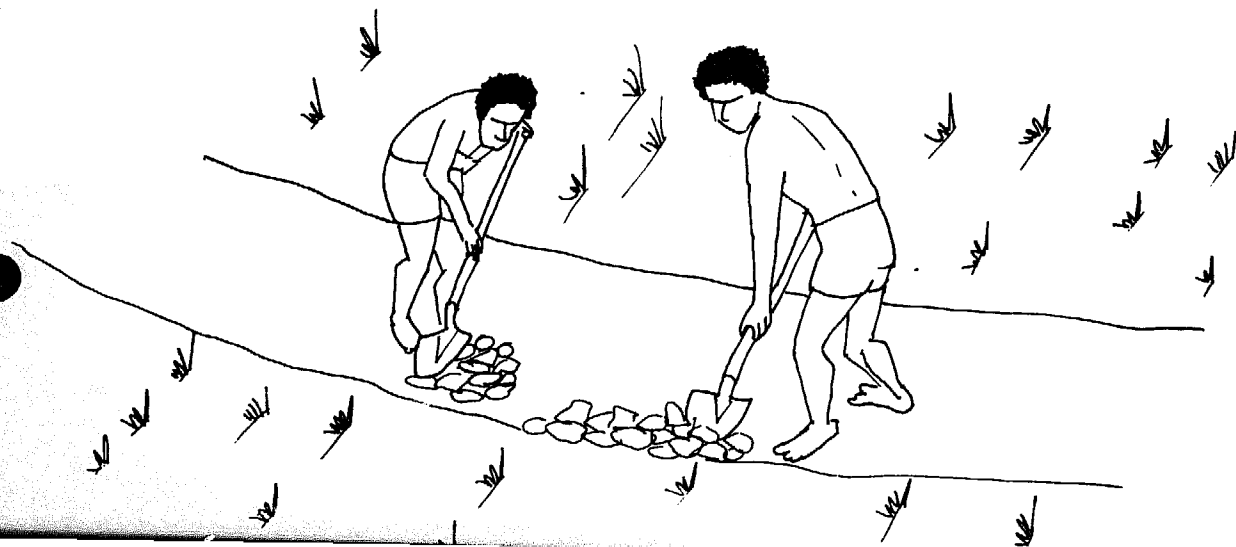

## A. GRADIENT

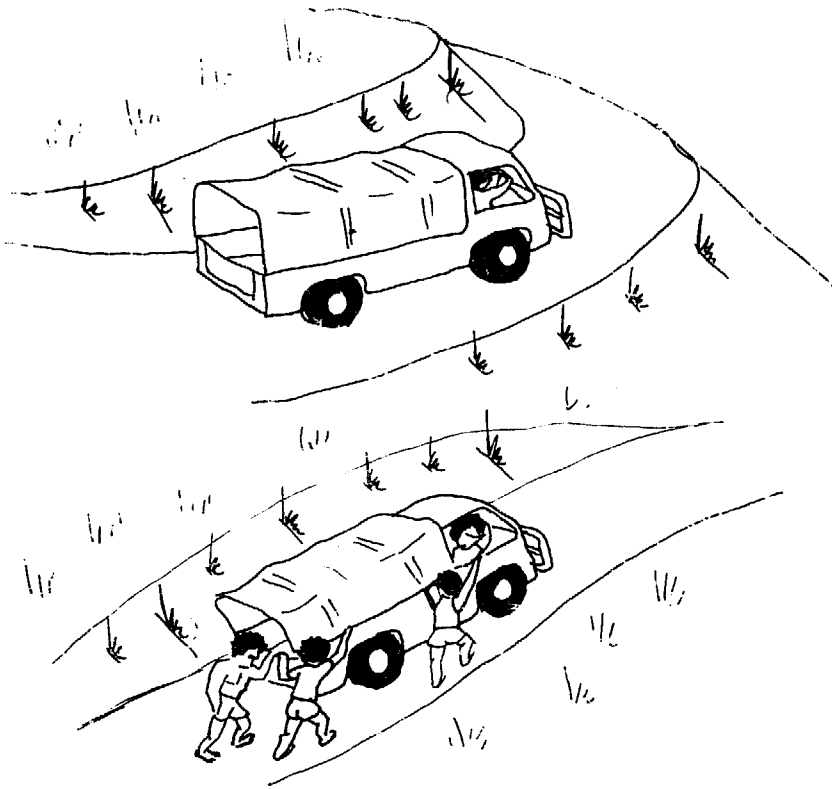

A Truck can easily go up this road because the road is not too steep. This road has a low gradient.

A truck cannot go up this road easily, because the road is very steep. This road has a high gradient.

The gradient of a road talks about the steepness of a road. If your first work on a road follows the right gradient, then you can easily look after the road and improve it later.

There are five reasons why you should not build roads that are very steep.

1. It is hard to improve a steep road. Suppose you want to make a small road bigger. If the road is not too steep you can just make the road wider. You will need some more money and work, but not too much. But if the small road is a very steep road, you cannot make it wider. You have to make a new road that is not so steep. This costs a lot of work and money.
2. Not all trucks can go up very steep roads. Suppose a truck tries to go up a road that has only a little bit of surfacing material on it. An ordinary truck can go up the road if it is not too steep. But an ordinary truck cannot go up the road if it is too steep. You need a 4-wheel-drive truck to go up a very steep road and 4-wheel-drive trucks cost a lot of money.

## SECTION 2 : GENERAL TALK ABOUT HOW TO CONSTRUCT ROADS

This book is to help people supervise work on self-help and Council roads. If you have a hard problem that this book does not help you with, men from the Department of Public Works will help you. You can ask the District Works Officer or the District Works Engineer in your own District, or you can write to the Local Government Engineer in Port Moresby. His address is on Page 2.

### What are these self-help roads used for?

They are built so that a man can drive a truck to a town or to a Council or Sub-District Office, trade stores, aid post, coffee co-operative, cocoa fermentary, air-strip, wharf, resettlement area, quarry, ferry, mission headquarters or school, or to join a Highway or big road. Papua New Guinea needs a lot of roads like these, but there is not much money.

### Four things are important when you build Council roads and Rural Improvement Roads.

These roads should be :

1. Cheap to build
2. Cheap to maintain
3. Safe
4. Open for trucks to use in most weather

### How can Councils build roads that are cheap and safe and almost always open for use?

The things that help most have special names. Here are five of these names.

- A. Gradient - the steepness of road. You can read about this on pages 6 and 7.
- B. Drainage - getting water off the road. You can read about this on pages 7 to 13.
- C. Surfacing or Sheeting - putting material on the road to make it stronger. You can read about this on pages 13 to 15.
- D. Formation of the Road - how wide it should be and the distance between the drains. Read page 16.
- E. Horizontal Alignment - building roads with no sharp bends. Read pages 16 and 17.

We will talk about these things one by one. First we will help you to understand them; then we will help you to learn how to use them to make roads that are cheap and safe and good roads.

Councils can upgrade old roads.

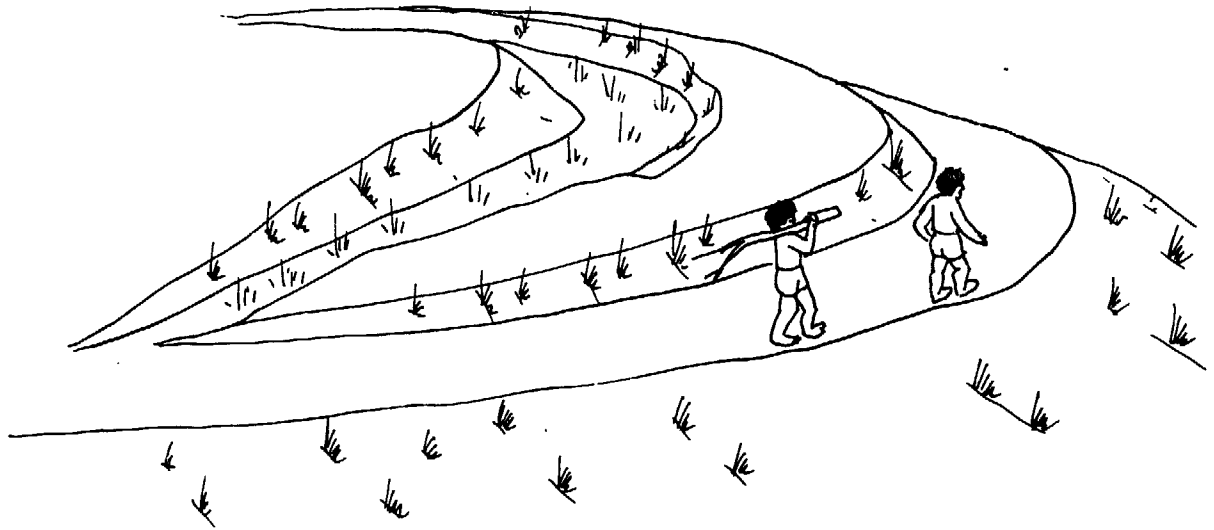

This book will help Council supervisors do these things well  
In all this work, Councils need men who have read this Construction Book  
because it tells them the best way to construct roads, and maintain them  
and upgrade them. These men must understand this book and do what it says.

3. A truck has to work hard on a road that is too steep and it will damage the road. A truck has to work very hard on a steep road. This has two bad results. The first bad result is that the wheels throw out the loose surfacing material from on top of the road. This is dangerous. The second bad result is that the wheels work hard and they make deep holes and cuts in the road. You have seen the deep cuts that a tractor makes on a road that is steep or soft. The village people or the Council men have to keep on working hard to fix the road. Also, if there is not much surfacing material in that area, you do not want to waste it by fixing up the same roads all the time.
4. Very steep roads are dangerous. When you are going down a steep hill in a truck, you have to go down very slowly. You put on the brake to go slow, and this can make you slide. Sliding downhill in a truck is very dangerous because you cannot control the truck. You might have an accident. An accident like this can easily happen when there is only a little bit of surfacing material.
5. Rain water damages very steep roads more than it damages roads that are not so steep. Why is this true? When it rains, water falls on the road. The water runs off a flat road slowly. The water runs off a steep road very fast. When water runs off fast, it makes holes and cuts in the road and it washes off the surfacing material.

If a councillor wants you to build a very steep road because he says it is a short road, will you be able to tell him why his idea is not a good one? I have given you five (5) reasons why very steep roads are bad. I will say them again now:

- 1: It is not easy to make a very steep road bigger:
- 2: Not all trucks can use a steep road.
- 3: A truck has to work hard on a steep road and the truck damages the road.
4. Very steep roads are dangerous when you go downhill with the brake on.
5. Rain water falls off steep roads very fast, and this damages the road.

#### B. DRAINAGE

Water is bad for roads.

Here are three reasons why water is bad for roads:

1. When it rains, trucks can get bogged if the water stays on the road.
2. Water that stays on a road makes deep holes and cuts in the road.
3. Water makes the ground near the road soft and loose. When the ground is loose, it can fall on the road and block it.

Can you stop these bad things? Yes, good drainage stops these bad things. Drainage carries water away from the road so that the water does not damage the road.

Here are four ways that good drainage can help you:

1. Good drainage gets the water off the road to the side before the water washes off the surfacing material and before it makes deep cuts along the length of the road.

Three things help you get this good drainage:

- (i) First, you should build the road with a curved surface like the one in this picture:

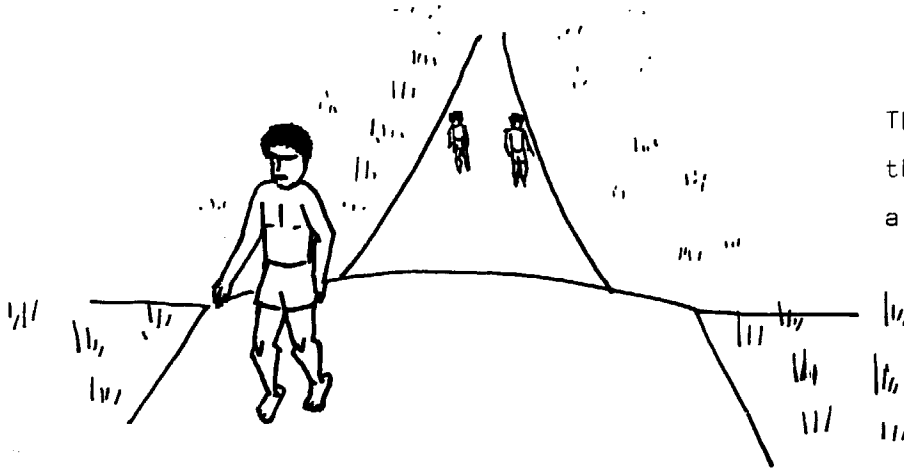

The rain water runs off the road with a curve or a camber like this.

- (ii) Secondly, you build side drains. The water runs off the curved road into the drains, like in this picture:

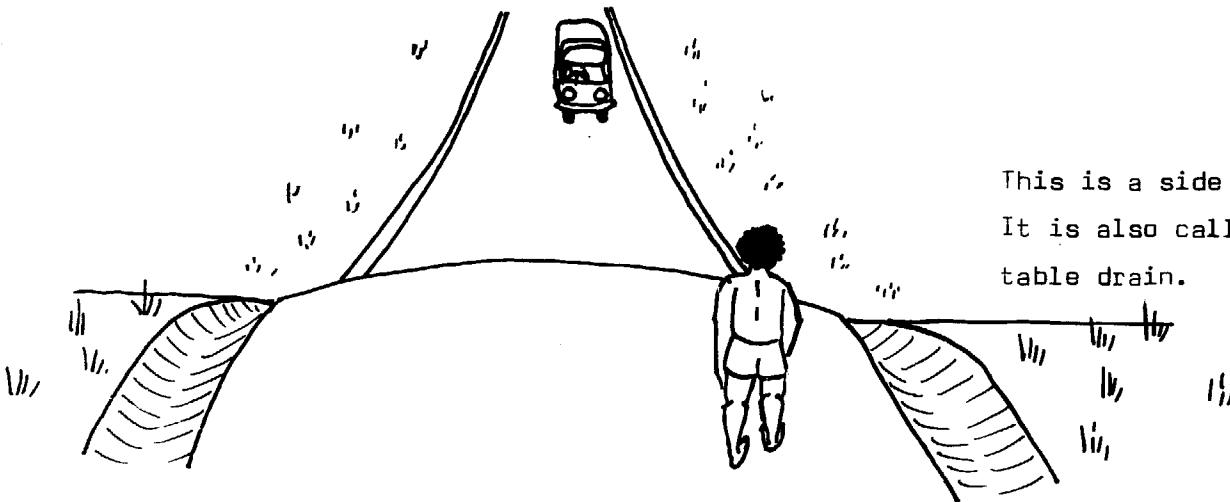

This is a side drain. It is also called a table drain.

You might need more than one patch drain. You might also need a relief drain for very heavy rain.

4. Good drainage prevents potholes before they start. When it rains, holes fill with water. When a truck wheel drops into a hole filled with water, the wheel makes the water splash up hard. The water washes away the ground around the hole. This makes the hole bigger. The hole can become a boggy patch. Good drainage carries away the water so that a hole is not made in the road surface.

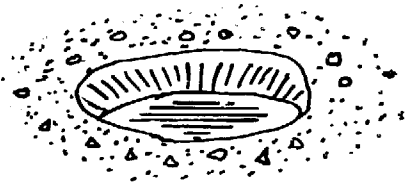

This is a small pot-hole.

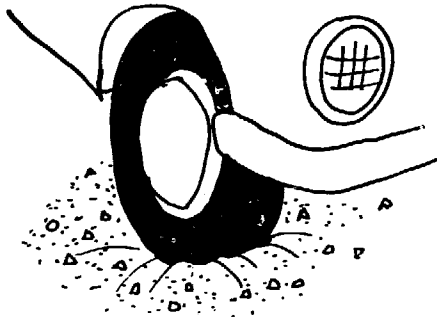

This truck wheel is splashing water out of the pot-hole.

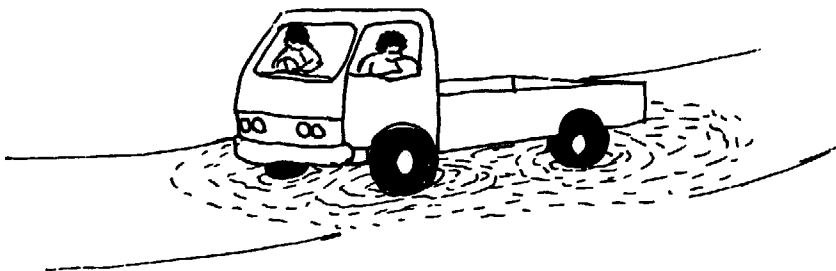

This truck is stuck in the boggy patch that was formed.



Some roads are cut into a hillside in this fashion:

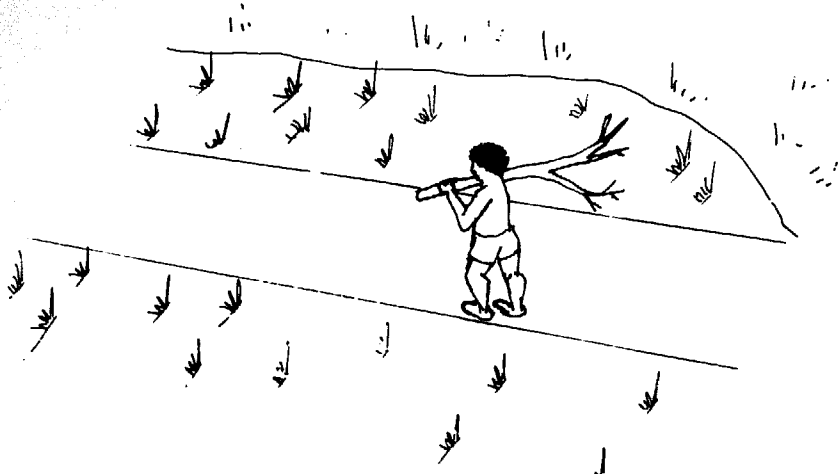

This picture shows a bench-cut road. It is cut into a hillside.

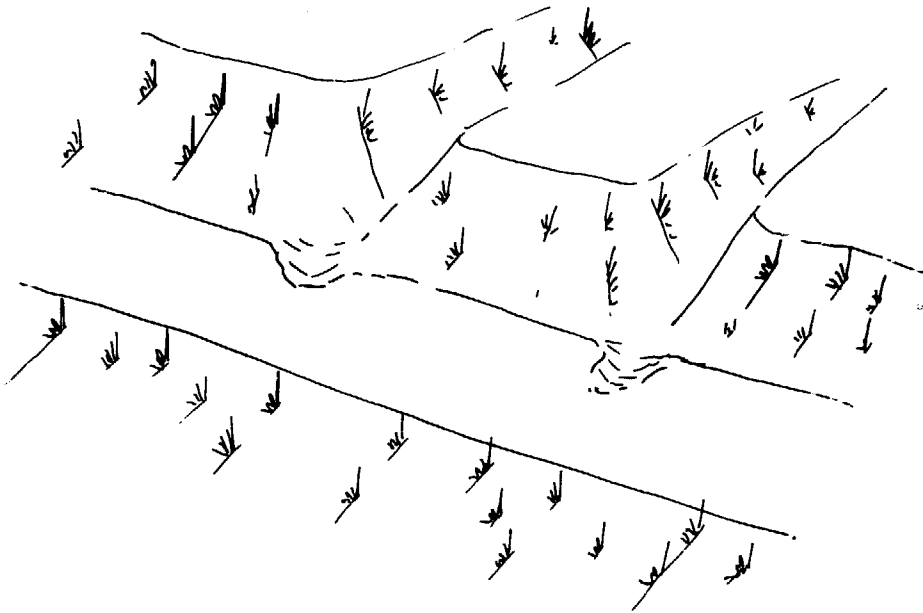

The banks above the road can be washed away. (This is called erosion). The road itself will also wash away.

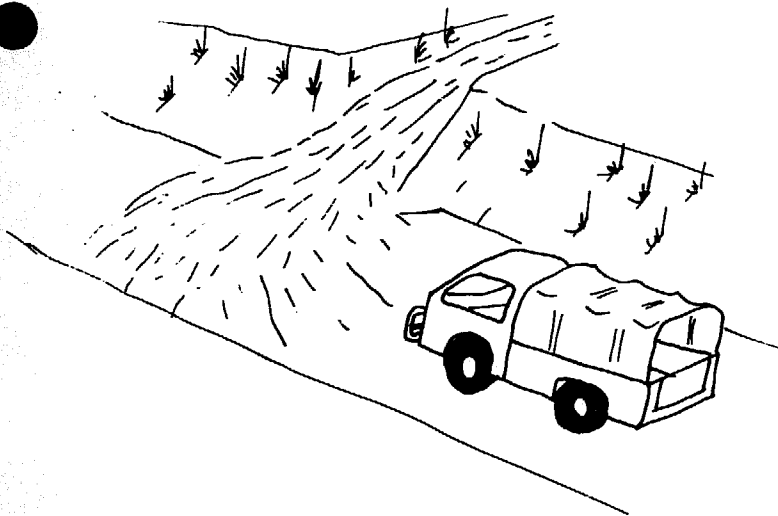

The ground above the road can become loose and slip on to the road. This can block the road. This is called a landslide.

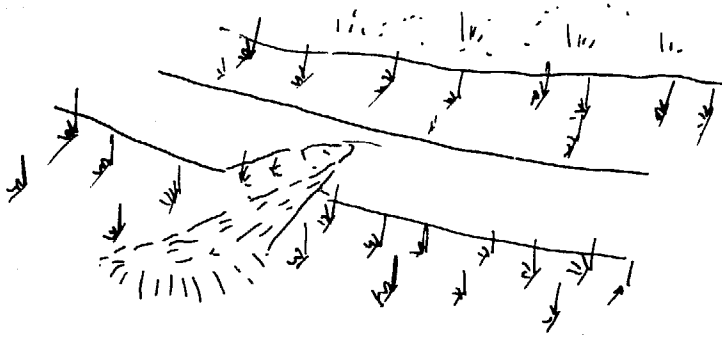

This is a different sort of landslide. The road is loose and has fallen down the hillside.

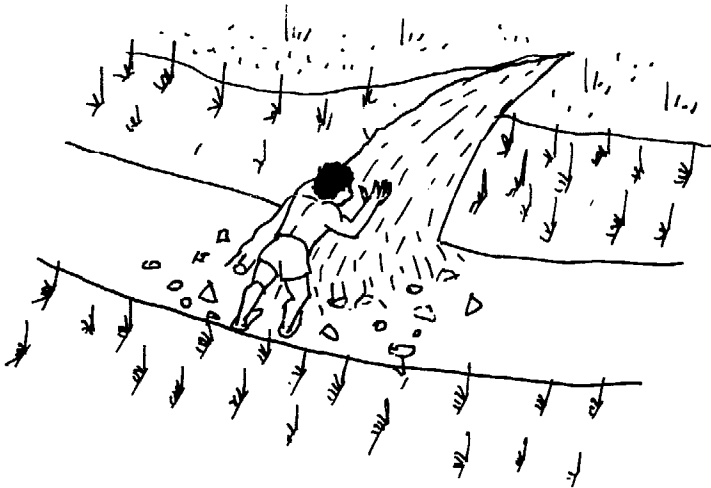

Can you stop a landslide?

No, you cannot stop a landslide, when it has started to slide.

But you can help prevent a landslide. That means that you can help to stop it before it starts. A good road builder will help prevent a landslide by making a catch drain above the road.

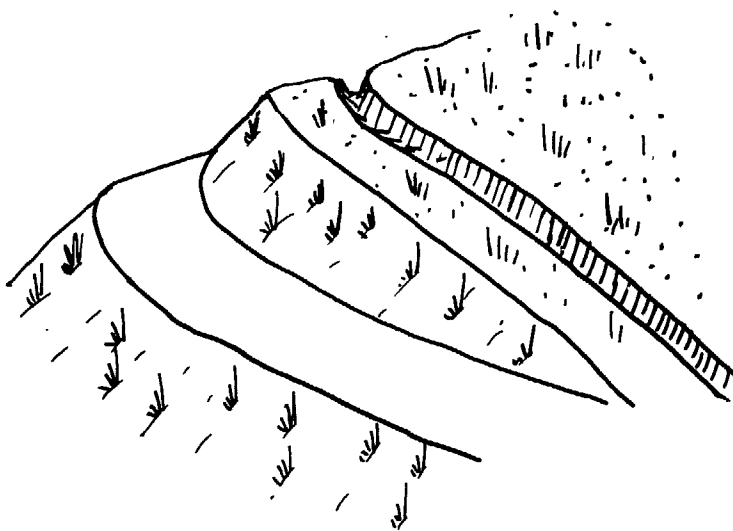

This picture shows a catch drain. A catch drain catches the rain before it gets to the road. The catch drain carries the water away so that the water cannot cause landslides.

(iii) Thirdly, you should build special drains called relief drains to carry away the extra water that falls in the wet season. In the wet season, it rains very hard. There is a lot of water and it quickly fills up the side drains. You do not want the water to stay on the road because it will hurt the road. You want the extra water to run away. You build relief drains going away from the road like the ones in this picture. These relief drains carry away the extra water that falls in heavy rain.

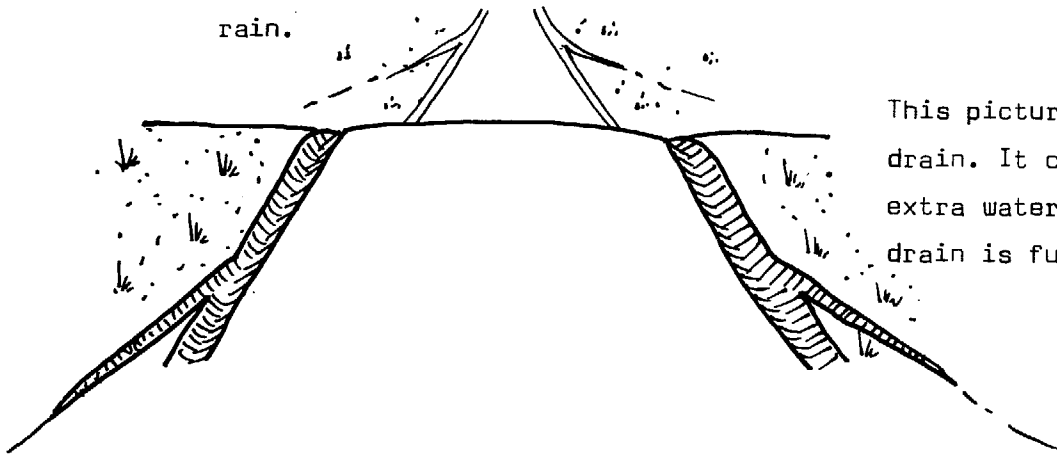

This picture shows a relief drain. It carries away the extra water when the side drain is full.

2. In swampy ground, good drainage keeps dry the ground under the road. When the ground is swampy, the ground under the road can be wet. The wet ground under the road can make the surface weak. Heavy trucks can go through the weak road surface and get bogged. Also, the wet ground can make the road bumpy. Bumpy roads are not good for trucks. You can stop these bad things with good drainage.

If you have to build a road where the ground is swampy, ask the District Works Engineer or the Local Government Engineer. He will tell you the best sort of drainage for your bit of swampy ground. He will tell you the best drains to carry the water away from the road, so that the ground under the road will not be wet, and so the road will not get weak or bumpy.

This good drainage will mean that trucks will not get stuck on the road, and you will not have to keep fixing the road all the time.

3. Good drainage helps to stop water from causing landslides and washways on bench-cut roads.

Heavy rain falls down hillsides fast. If there is no special drain, the fast water running down the hill will fall onto the road. This fast water will cause two bad things called erosion and landslides. You can see them in the pictures on page 10.

You should now know four reasons why you need drains for a road:

WATER IS BAD FOR ROADS. DRAINS KEEP THE WATER OFF THE ROADS.

1. Relief drains carry away extra water in the wet season.
2. Good drainage in swampy ground stops the ground under the road from being wet and from making the road boggy and bumpy.
3. A catch drain above a bench-cut road can help stop Landslides and can help stop the banks and the road itself from washing away.
4. Drains stop pot-holes from forming and from getting bigger.

### C. SURFACING MATERIAL

1. Surfacing material or "pavement" is the name given to the things you put on a road to make it stronger. Put your hand on top of the table. Now you are touching the surface of the table. The surface of the table is the part that you write on, or put plates on. The "surface" of a road is the top layer of the road where the wheels of a truck drive.
2. What can you use to put on top of roads in your area ?  
If you are from the north coast or one of the islands, you might have coronous roads.

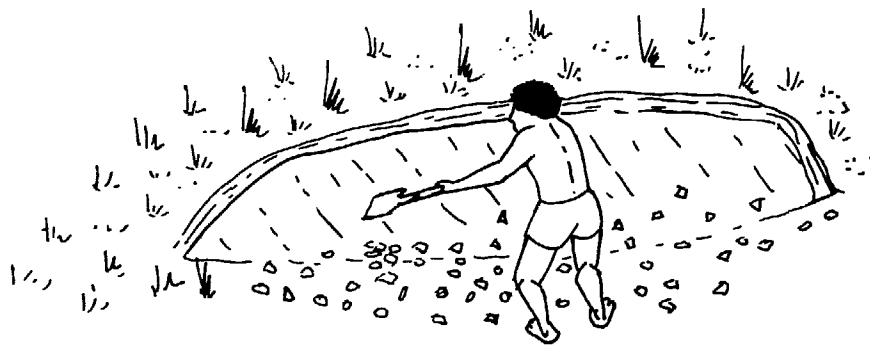

This is a coronous pit.  
Coronous is white. It is  
made of sand or coral and  
sometimes has shells in it.  
It makes a good hard surface.

#### D. FORMATION OF THE ROAD

Formation of the road talks about how wide a road should be, from one side to the other:

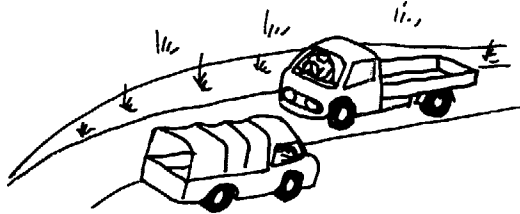

This picture shows a narrow road. Only one truck can use it.

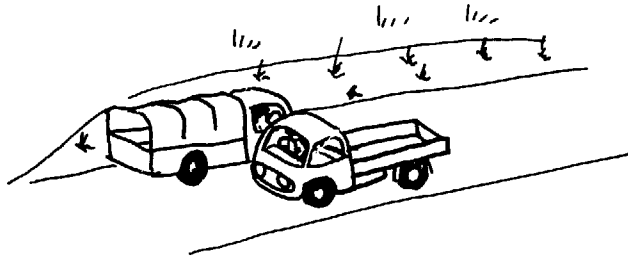

This picture shows a wide road. Two trucks can use it and pass each other.

Formation of the road also talks about the distance between the side drains. Formation of the road is important if there are many trucks using the road. It is not important on a road that is used only a little bit.

#### E. HORIZONTAL ALIGNMENT

Horizontal alignment means the shape of a road in plan (as you would see it from a place, looking down.)

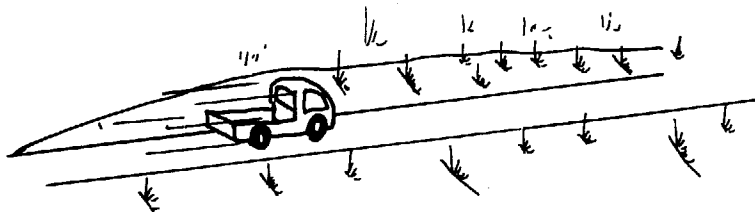

A straight road has good horizontal alignment and cars can go fast.



Natural sand from beaches or river beds may be used on your roads. Gravel from ridges or hillside gravel pits can also be used.

We call these "material" because material is a word that you can use for different things like coronous , river gravel, stones, sand. We call them all "surfacing" material because they are used for the surface of the road.

3. When do you use surfacing material?

When you make a road you must have surfacing material. There are three reasons why you must have surfacing material:

1. You need surfacing material to make the road safe and strong.
2. You need surfacing material so that all kinds of vehicles can use the road.
3. You need surfacing material to save maintenance money.

You must have surfacing material, and if the road is not built through rock or natural gravel, you have to cart it onto the road.

You should look in the bush near the road, and ask the people who live there, to find all the places where there is coronous, or river gravel, or other surfacing material.

It costs a lot of money to put surfacing material on a road. It takes a lot of time also. Do not waste the surfacing material on a road that is very steep and curves round a lot if you can build the road in a better place. It is better to build a good line of road, than to do a lot of work putting surfacing material on a bad line of road.

If you are from the highlands, they might use river gravel in your area.



This truck is getting river gravel to put on the roads.

If your Council is a big one, you might have a quarry and a crusher.



This is a quarry. Men blast big rocks or dig up the stones by machines such as bulldozers.

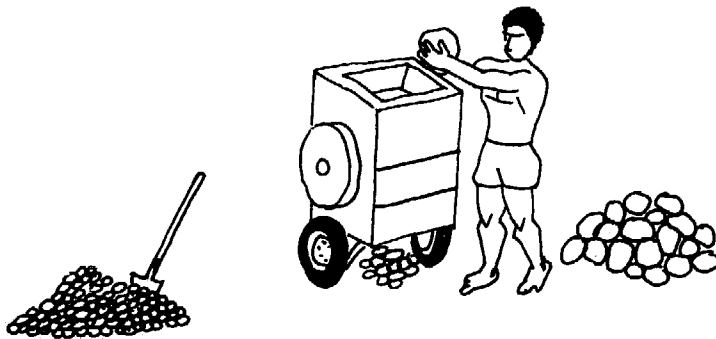

This is a crusher. Big rocks are broken up in this machine, to make gravel, which is a very good surface.

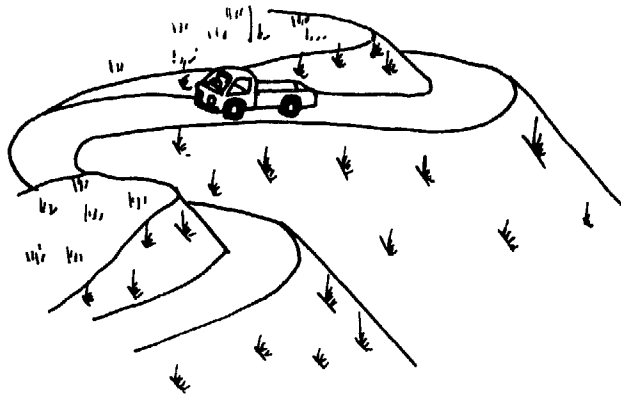

A road with many sharp bends has poor horizontal alignment.

When a lot of fast trucks and cars use a road, you need good horizontal alignment. Most Rural Improvement Roads are rough. Trucks go slowly. Bad accidents are not often caused by fast trucks on these roads.

Horizontal alignment is not important on these roads. When you want to build a Rural Improvement Road, ask the Local Government Engineer at Public Works Department for a surveyor. He will show you where the road should go. He will not worry too much about horizontal alignment on a small road.

But suppose you want to change a small road into a big road, or suppose you want to start building a new big road. Then the surveyor will be careful about horizontal alignment. Horizontal alignment is important on a big road so that fast cars and trucks do not have accidents.

Good horizontal alignment is easy in flat areas. It is also easy in areas that are a little bit hilly. It is not easy in the mountains because the road has to be built up. This is a hard job and it costs a lot of money.

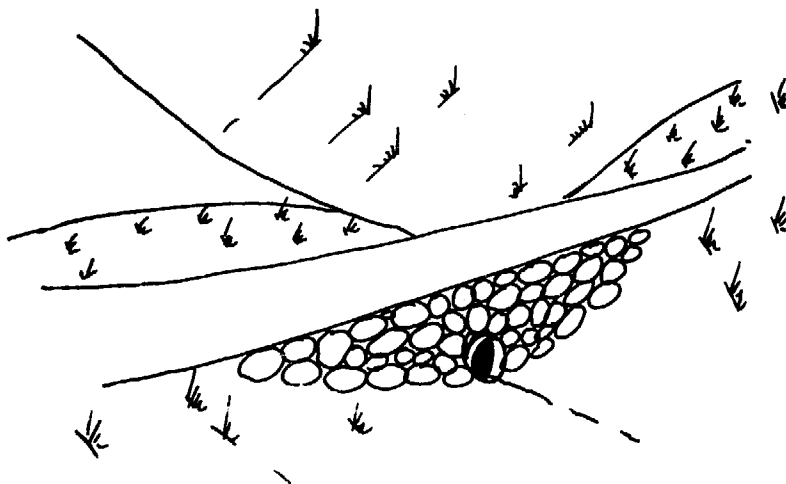

This shows the way you get good horizontal alignment, in the mountains. The road is built up on one side.

Suppose you build a small road that is not too steep. Later on you can make the road wider. This saves a lot of money and work.



## F. SUMMARY

On Page 5 we said that there are four important aims for Council roads and Rural Development Roads. Five things help you get these aims.

The four aims are these:

Council roads and Rural Development Fund roads should be:

1. Cheap to build.
2. Cheap to maintain.
3. Safe.
4. Open in most weather.

The five things that you get these four aims are:

1. Good gradient—roads should not be too steep)
  2. Good drainage. )
  3. Surfacing material )
  4. Good road formation - a road has good formation if it is wide enough for the traffic that uses it. )
  5. Horizontal alignment is important for big roads with a lot of fast traffic. )
- These 3 things work together. It is a waste to surface a road that is too steep. It is a waste to surface a road that is drained badly.

Now you know what your aims are. You also know what helps you get these aims. In the next part of the book, we will talk about what you do when you are building a new road or making an old road bigger.

1. First you get a surveyor to survey the road.
2. Build the road to the right gradient - not too steep.
3. Put surfacing material on the places where it is needed, especially on the slopes.

If you are improving an old road to make it bigger and better you do three more things:

4. Improve the horizontal alignment so that cars and trucks can go faster.
5. Replace the old bridges and culverts where needed.
6. Surface all the road.

A. THERE ARE DIFFERENT SORTS OF SURVEYS:

1. A survey for roads that are already built. The surveyor may not put in any pegs where the ground is flat or only a little bit steep because he will not want to change it. But the surveyor will want to change the place where the road is too steep in one part. He will measure this part and mark it with pegs, for a new line.

2. A survey for new roads. Usually, the surveyor pegs all the places where the road will be built. The pegs should be put in so that the ground level at the peg is exactly the same as the surface of the road will be built to.

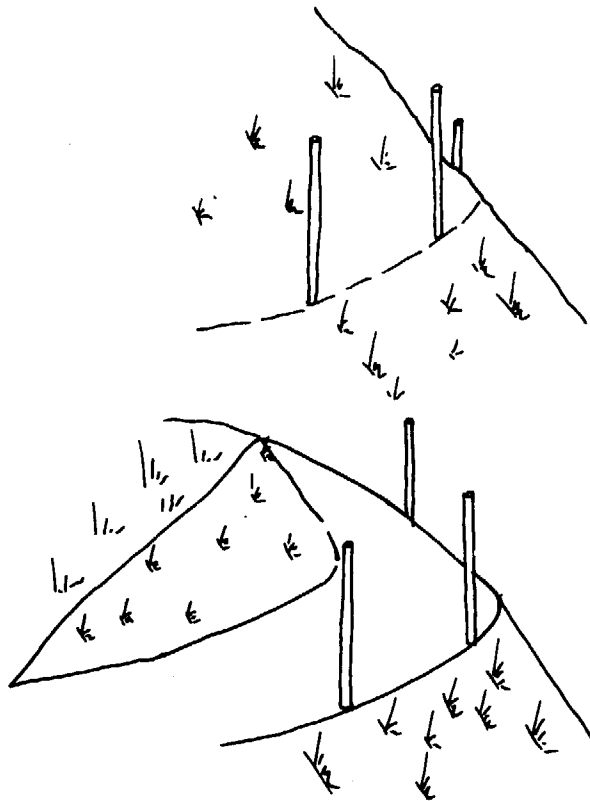

This picture shows a line of pegs where the road will go.

This picture shows the road formation level built to what was said on the surveyors pegs.

Sometimes a hill will have to be cut away below the level of the ground at the peg. These places are called cuts. Here the surveyor will write on the peg a minus sign and the depth of cut. "-1.5" would mean "Cut 1.5 metres below the ground at the peg".

When you build the road along this baseline, the road is in the best place. Papua New Guinea needs many new roads. Papua New Guinea does not have many surveyors and they cost a lot of money. The survey of Rural Improvement Roads is usually quick so that the surveyor can go off to the next job.

The Surveyor leaves pegs in the ground. What are they for?

The pegs he leaves in the ground show where the road should go so that it is not too steep.

Usually, the pegs are bush stakes. These are sticks cut from a tree. The pegs will be painted, if possible. All pegs will have numbers written on them. The numbers are in order - 1,2,3 and so on. Rainwater cannot wash off the numbers. The pegs show where the road should be cut. On a hill, the pegs do not show the place where the centre of the road will be. The pegs show the place where the edge of the road will be:

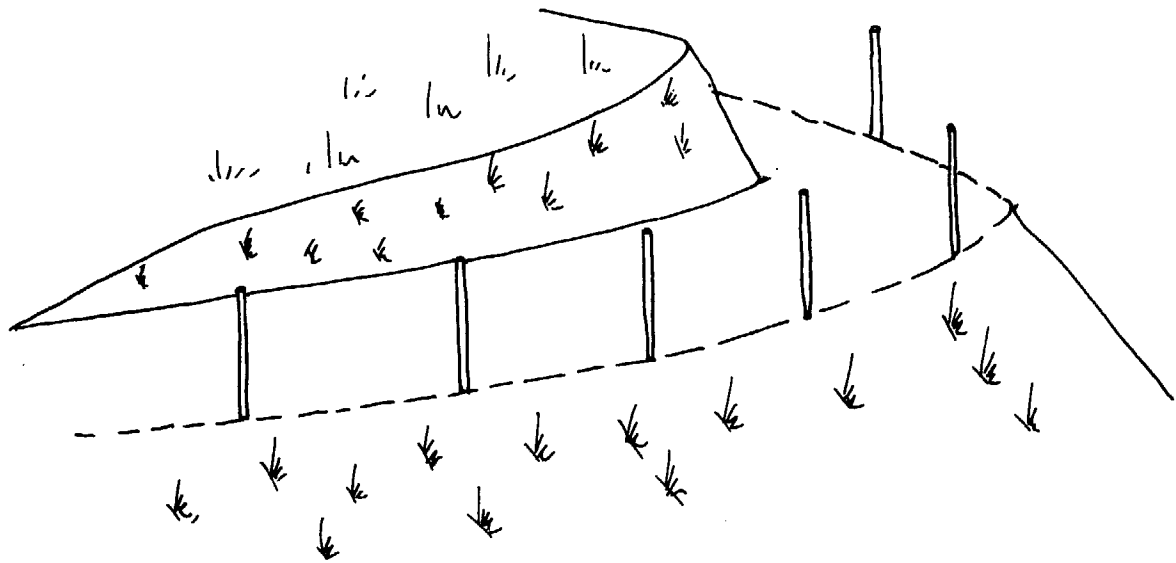

It is very important to leave the pegs exactly where they are. In Section 4 on pages 26 to 32, you will learn about marking the place where the road will go. Do not move the pegs before the "permanent identification" is made, and you have marked the place where the road will go.

### SECTION 3 : SURVEYING A ROAD

First you must survey the place where the road will go. Then you can build the road.

If the ground is flat and hard you do not need a survey to find out where to build the road, but before work starts the Supervisor of the road must make sure the whole road can be built. He must check that there are no land disputes, swamps, cliffs, or other trouble that might stop the road. If you are going to build a road through a swamp or up a hill or mountain, you need help. You can ask Public Works Department in your district for a surveyor, or you can write to the Local Government Engineer at Public Works Department in Port Moresby and he will send a surveyor. To understand more about this see page 2 "Requesting a Survey".

#### What does the Surveyor do?



The surveyor will use a special tool or "instrument" to find out where the road should go. He will put markers called "pegs" in the ground that mark the place for the road. If you line up all the pegs you have the gradient line.





Before cutting.



After cutting.

Sometimes you must fill in a hollow, over the place where the surveyor puts the peg. These places are called fills. Here the surveyor will write on the peg a "plus" sign and the height to fill. "+2.2" would mean "Fill 2.2 metres above the ground at the peg".



Before filling.



After filling.

In steep ground, the surveyor will measure how far it is between the pegs. The pegs have numbers painted on them that show how far it is to the next peg. The surveyor writes a report about everything, and a copy is sent to the Council, in case you need to check something.

3. A survey in an area that is very steep and broken. The surveyor may not know whether a road can be built there. He will measure very carefully and put in pegs. He will tell the Council or people not to start work. He will take the measurements back to the Local Government Engineer. The engineers at Public Works Department will look at the measurements. Suppose they say it is a place where you can build a road, they will say to work from the pegs, or they may design a special road. Suppose they think it is a bad place for a road, they will tell you not to build in that place.

DO NOT TOUCH THE PEGS before you have a letter from Public Works Department. DO NOT START TO BUILD THE ROAD until you have a letter from Public Works Department. You do not want to waste your money and work by building in the wrong place.

4. A survey for a hairpin bend:

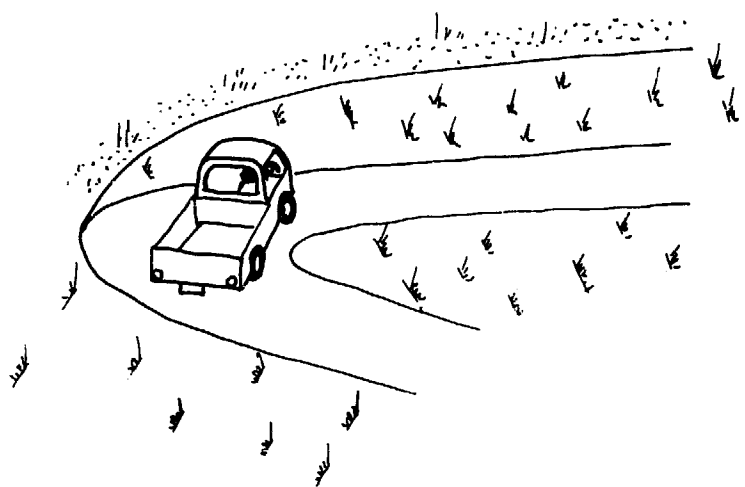

This is a hairpin bend

Hairpin bends are dangerous. The surveyor will try to have no hairpin bends for your road. If the road must have a hairpin bend, the surveyor will peg the place very carefully. You will build the road exactly where the pegs are. Then the hairpin bend will be as safe as the rest of the road. You can read more about hairpin bends from page 46 and 47.

3. THE SURVEYOR'S FIELD BOOK:

The surveyor writes all the useful facts in a field book. These are facts about measurements, directions, details of rivers, villages, tracks and roads along the place where your road will be built. The surveyor sends his field book to Local Government Engineer, Public Works Department. The engineers at Public Works Department will look at all this information. They will send the Council and the Area Authority a copy of the surveyor's report, and a letter that talks about any special problems or things to be done when you build the road. The engineers want you to build a road that is not too steep. They will tell you all the information you need to build the road in the right place. The field book will use the names of rivers, villages, tracks and existing roads to help you find the right place. If the engineer wants to talk about a place in between two pegs, he will give you a measurement from one of the pegs. The picture on the next page will help you to understand this.

SECTION 4 : MARKING THE PLACE WHERE THE ROAD WILL GO

The Surveyor puts marker pegs into the ground. After nine (9) months, these pegs are not good. Why are they not good? In the bush, the grass and leaves cover the marker pegs. Also the water in the ground makes them rot, and they fall apart. In villages, people move the pegs, and children take them to play with.

When the surveyor finishes marking the route with pegs, you must straight away mark the route permanently. Something "permanent" is a thing that lasts a long time, so your marks must last a long time.

A. HOW DO YOU MARK THE ROUTE PERMANENTLY?

Do you put steel pegs instead of wooden pegs in the ground? No, that is no good. Steel pegs do not rot, but they do get covered by kunai and pit pit, then you cannot find them when you want to work on the road. Do you cut a track to follow the pegs? Yes. This is the best way to mark the route. the route.

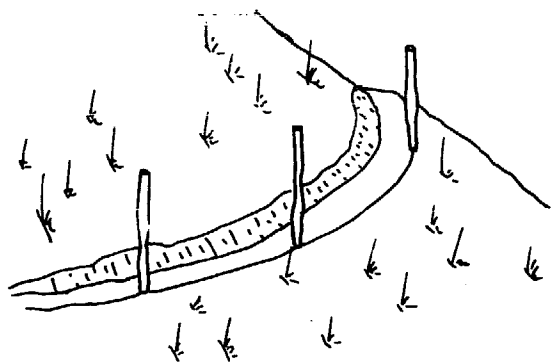

You cut a benched foot-track (called a pilot track) around the line of the survey.

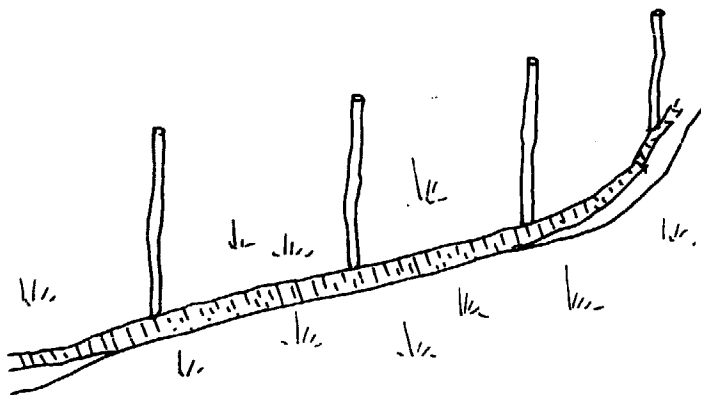

If the road is on flat country, you dig a small trench.

You must cut the track straight away before the bush grows over the pegs. If the bush grows before you start to cut the track then you must be careful. A falling tree can break a marker peg.

Suppose a peg has a measurement to show how much you should fill in a hollow. You start to measure from ground level at that peg.

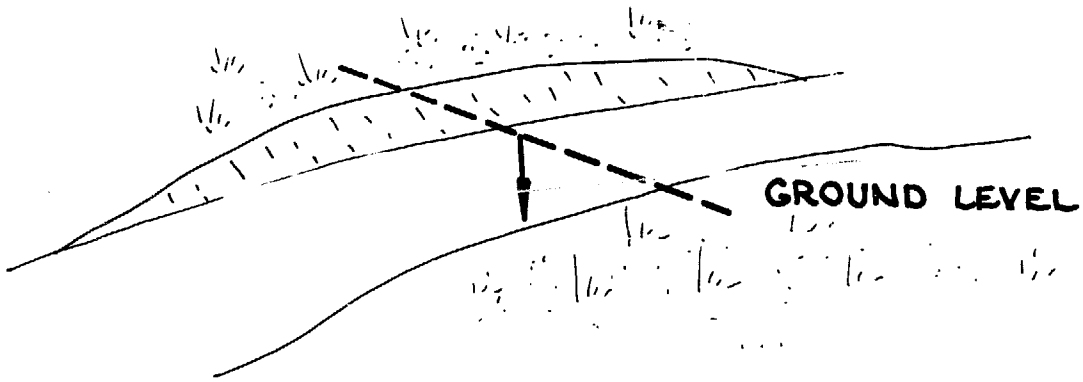

4. When all the road is good, it is a good road. When a road has some bad places, the road is bad. When a road has even one very bad place, the road is very bad road. Follow the pegs very carefully. Do what the surveyors and engineers say you should do. Then you will not have any very bad places on your road.

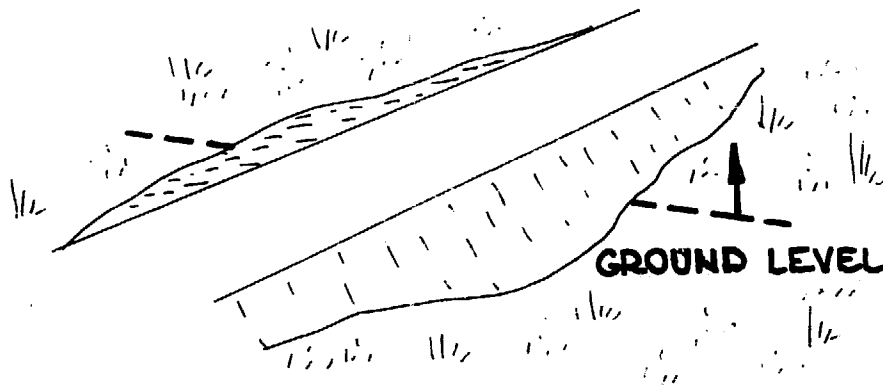



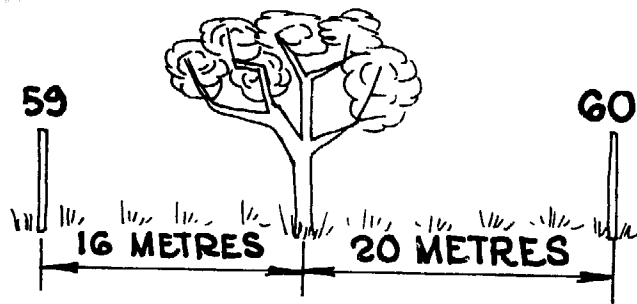

in the field book the engineer would say the tree was at peg 59 + 16 metres or peg 60 - 20 metres. That means the tree is 16 metres past the peg 59 and 20 metres before peg 60.

C. HERE ARE THE FOUR MOST IMPORTANT FACTS TO REMEMBER ABOUT SURVEYS:

1. Pegs sometimes mark the centre line of the road on flat ground, but on hillsides they usually mark the outside edge.

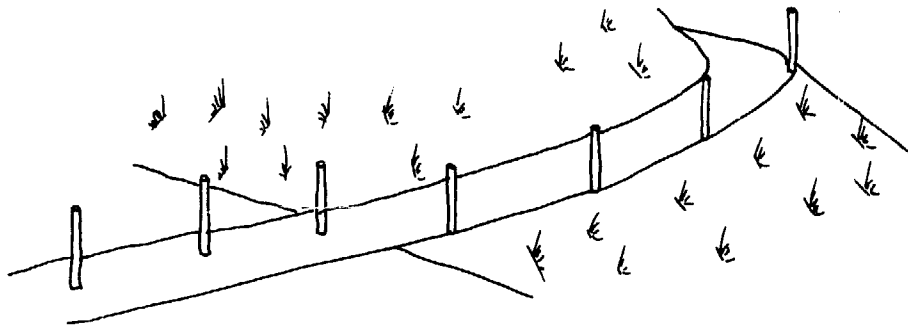

2. Pegs are usually placed so that the ground height or "level" at the peg is exactly the same as the height where the road surface will be.
3. Suppose a peg has a measurement to show how deep you should cut away. You start to measure from ground level at the peg.

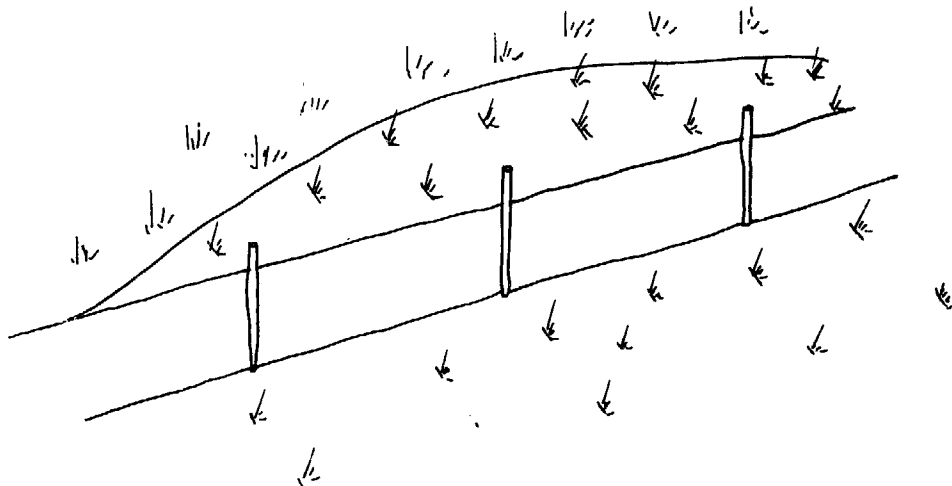

B. HOW BIG MUST YOU MAKE THE TRACK?

You make the foot track 1 metre wide.

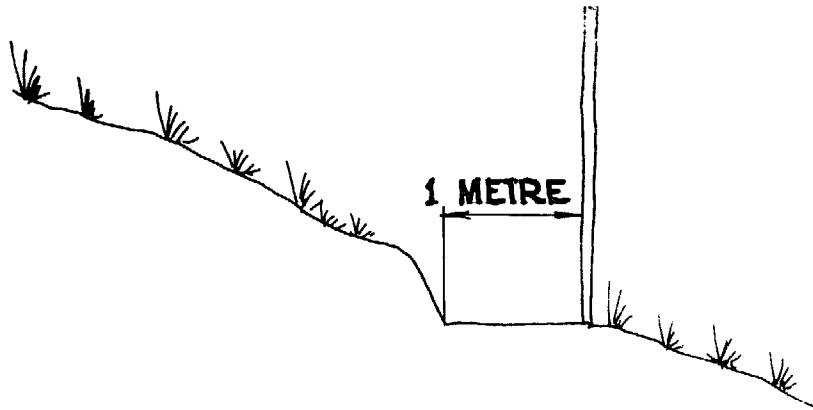

In flat country, you make the trench 1 metre wide and clear away the topsoil.

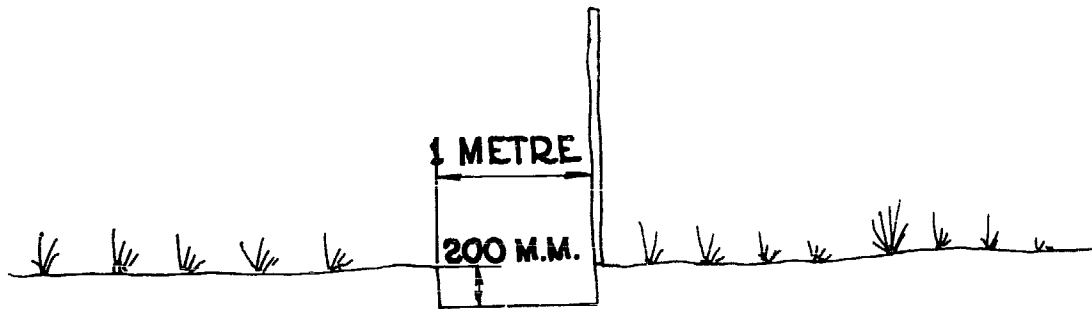

The surveyor puts pegs along the route. You must make the track wider in those places and leave the peg in the ground. Clear of the main track.

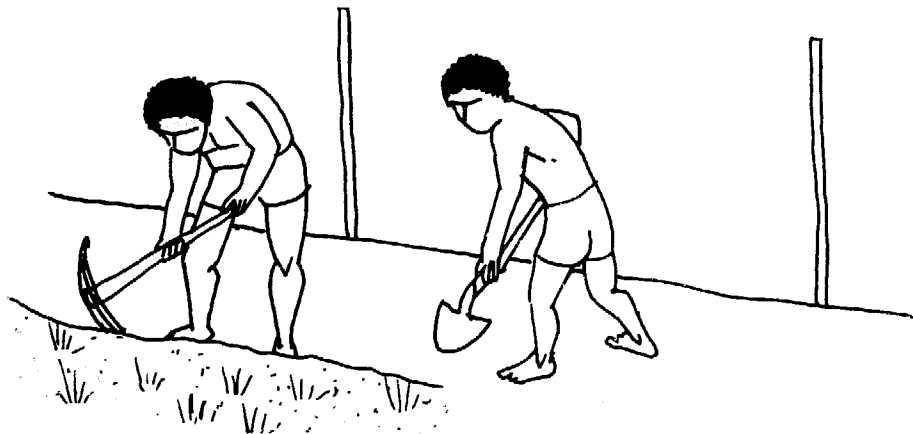

Suppose one peg shows that you must cut or fill in that place. You should get a bigger timber post or steel peg and paint the number on it and also print the height of cut or fill, like the numbers on the bush peg. Then you put this peg well in the ground, where the bush peg was. (Put the peg in so that it will not fall over). You know that you can start to make a road this year but maybe it will take years to finish. The pegs with the numbers must be steel or strong timber to stay there.

**C. HOW DO YOU MAKE A BENCHED ROAD TRACK?**

You must cut flat into the bank at the same exact place where the peg meets the ground. This is very important.

Now I will tell you how to make the track between pegs. The track should go where the road will go. If the hillside is curving, do not make the track as short as possible between pegs. Suppose you do that, the track could be too steep.

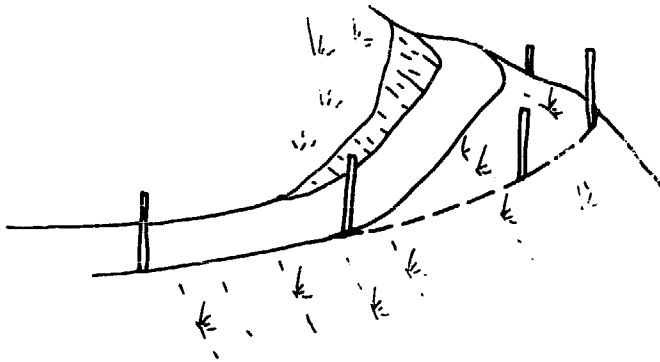

This is bad. The benching track does not follow the line of pegs.

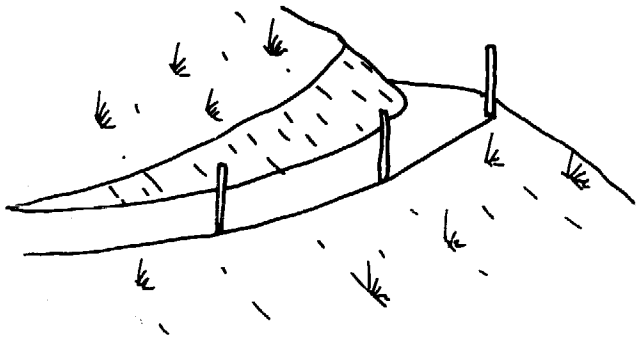

This is good. The benching track follows the line of pegs.

You must supervise the workmen when they cut the track on steep parts of a hillside. Suppose they make a short track that is very steep, you will have trouble when you make the true road.

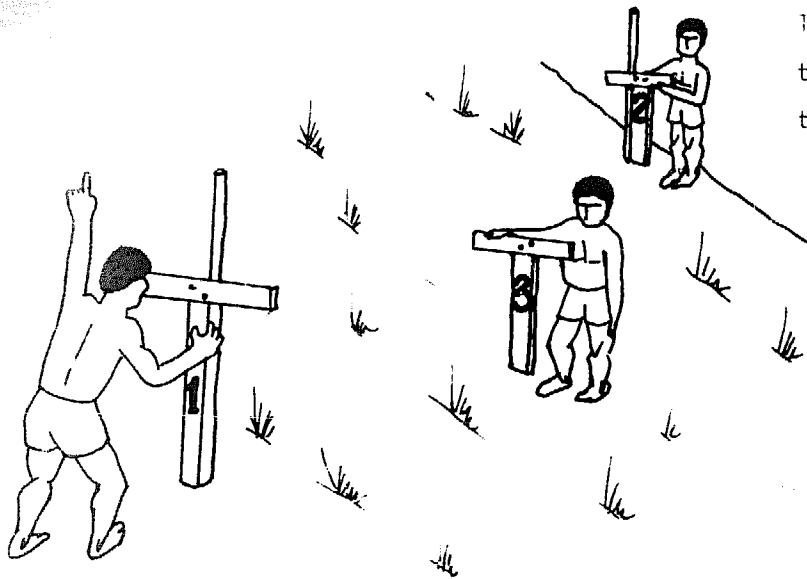

This man can see that rod 3 is too low. He can see where the track should go.

You can put in extra little pegs in the places where the third boning rod shows the gradient line.

#### USING A GRADIENT TEMPLATE:

When working around curved hillsides, it can be difficult to get an even grade, especially when you cannot see between pegs. If you work by eye only, you can be wrong, because slopes of road can look different when seen against different slopes in the background.

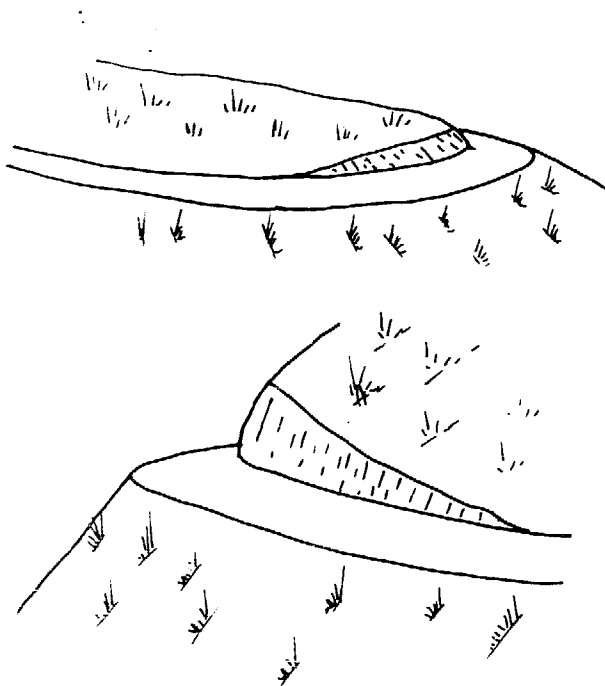

Both of these roads have a grade of 5% but they look different because of the shape of the hills on which they are built.

D. MAKING A GOOD EVEN GRADIENT WITH BUNING RODS:

Now, for hillside which are not very curved between pegs, I will tell you one easy way to make the track between two pegs with a good even gradient. You need three (3) pieces of wood. Each piece of wood will be one (1) metre high. Measure them so they are the same. Nail a piece of wood on top of each of them so they look like a "T".

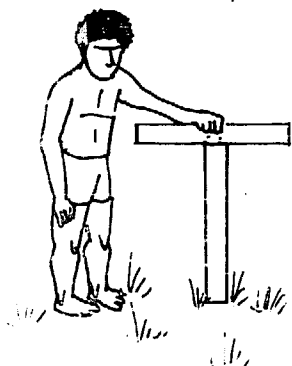

This is called a boning rod.

Put one "boning" rod at formation level at each peg and bend down so that your eye looks from the top of one rod to the top of the next rod. A man can walk along between the pegs with the other rod. He can rest this rod on the ground. Your eye will see if the third rod is very high above your line of sight, or very low below your line of sight.

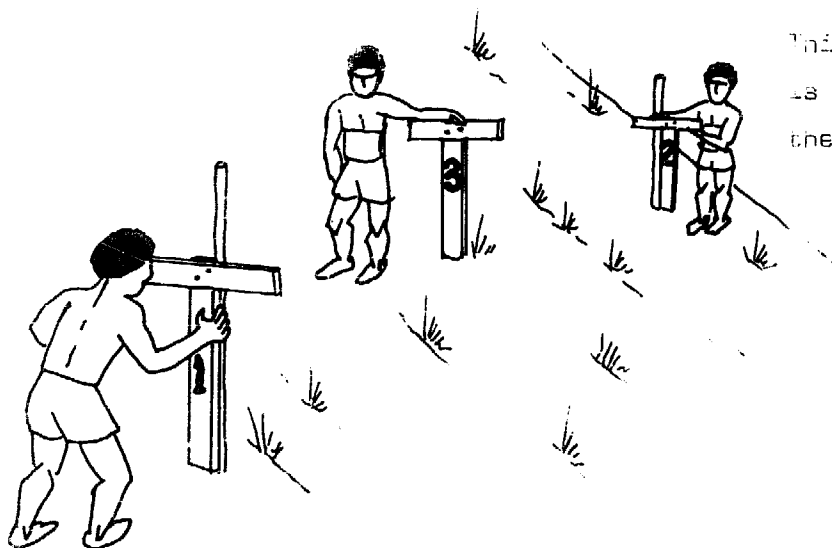

This man can see that rod 3 is too high. He can see where the track should go.

To work round curved ground between pegs, you need a gradient template.  
This is a wooden frame with a straight edge that can be set at different slopes or grades.

FLAT GRADE

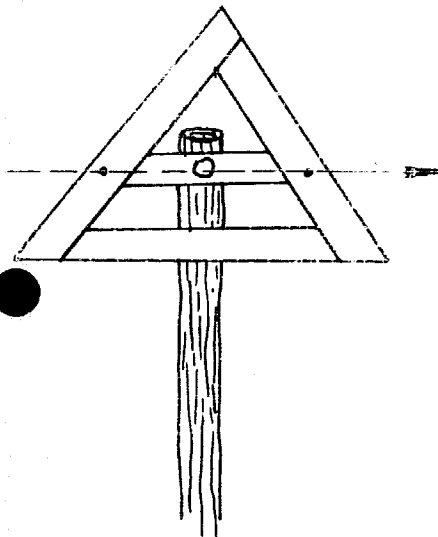

FALLING GRADE

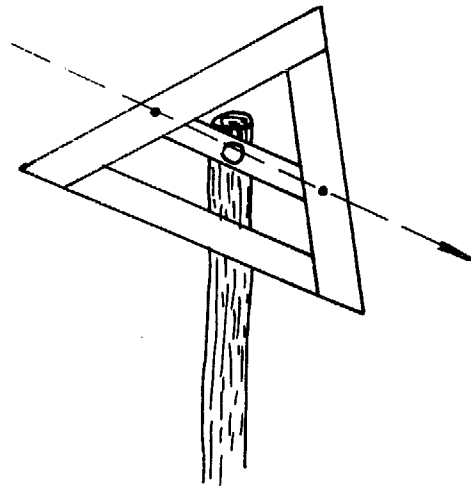

RISING GRADE

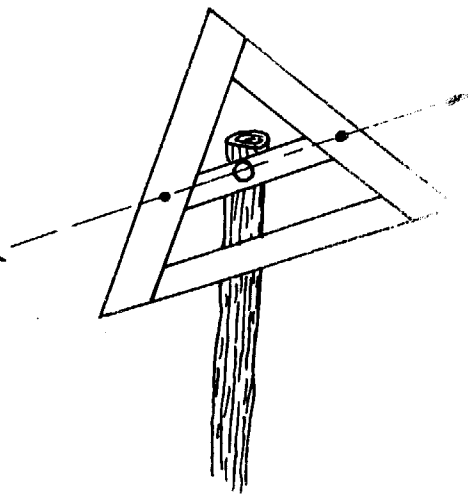

You hang a string with a weight on it from the top corner. The string goes past a mark on the other side showing the percentage of grade or the slope up or down.

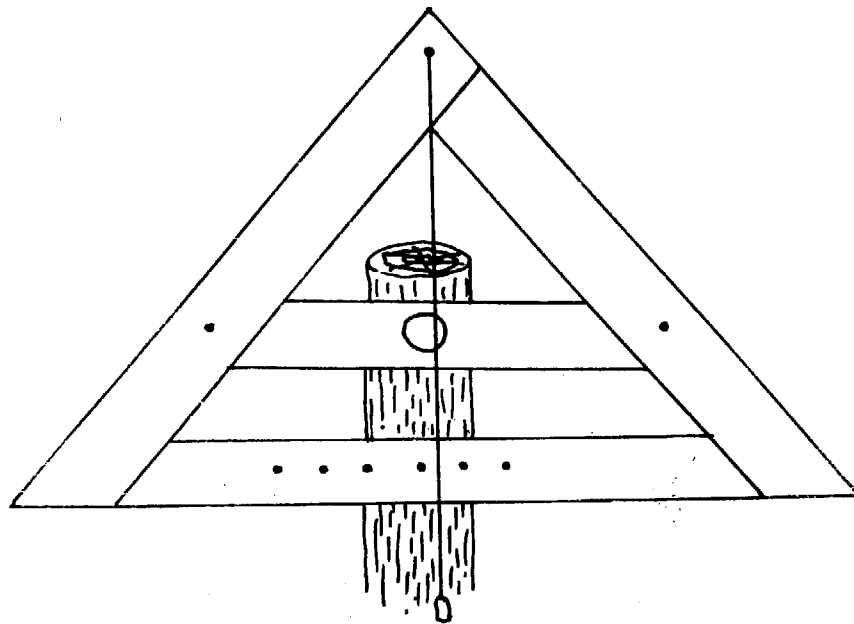

Then you can look along the bottom straight edge, and set the grade that fits properly around the curve between the pegs. Ask the Local Government Supervisor in your District to build you one of these gradient templates.

I want to say again that you should not go from one peg to the next peg in a straight line, when the hillside between them is curved. This is because the track might be too steep.

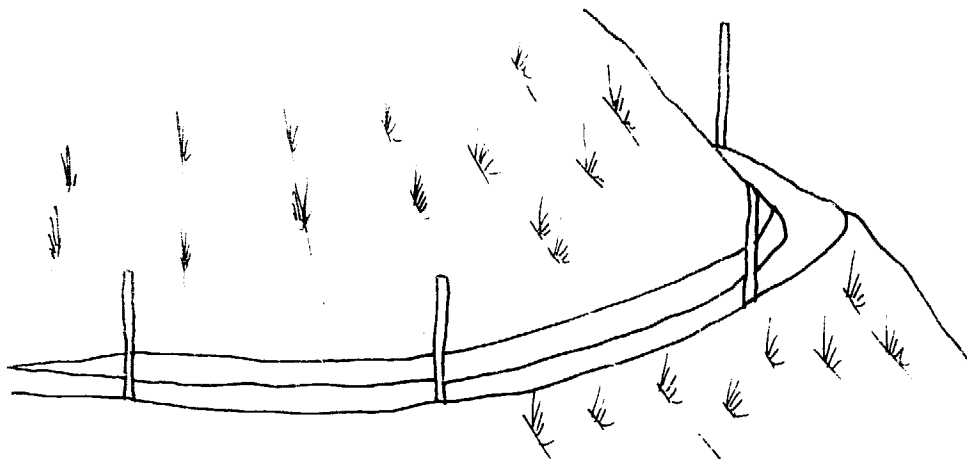

And because the track might need too much fill. (Gully)

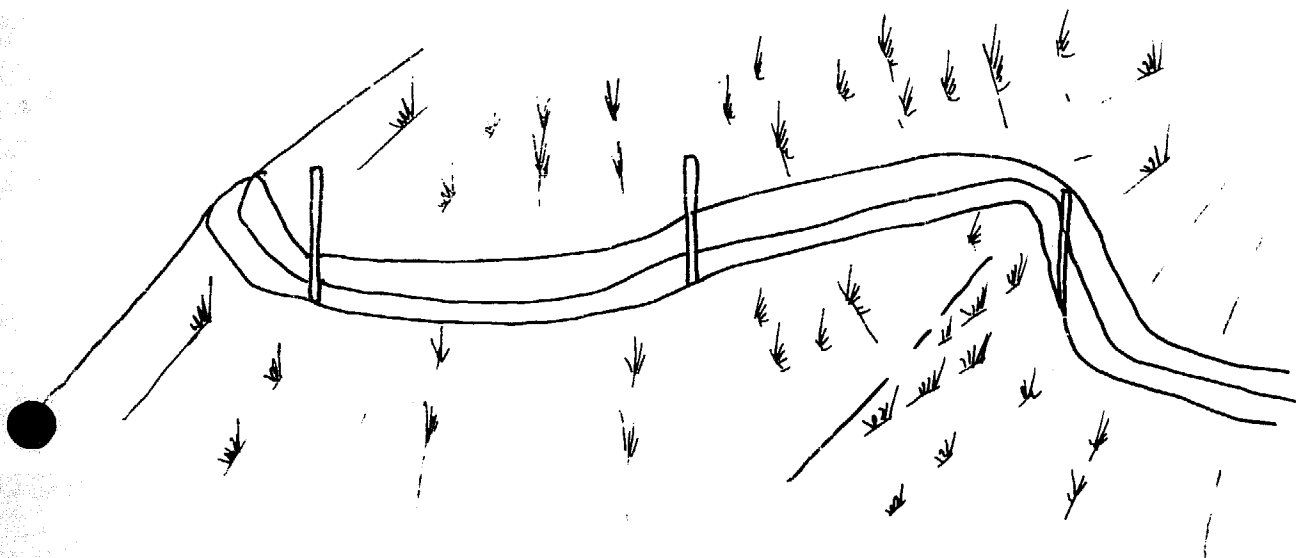

A lot of hard work would be needed to fill that gully in the picture. Also the fill would not be safe. It would sink. A big company like Dillingham's has big machines to make the ground hard and safe. Usually Councils do not have these machines.

You want to keep the track on the correct gradient, not too steep. Suppose the pegs show that you must make a cut or a fill when you make the road. You cannot make this cut or fill for the pilot track. The pilot track will not be on the correct gradient on these sections. But you must put in steel pegs or strong posts with the numbers painted on them. These new steel pegs must go in the same exact place where the surveyor put the bush pegs. When the true road is built, the overseer must look out that the pegs and the numbers on them are used to make the right cut or fill.

SECTION 5 : BEGINNING TO MAKE A ROAD

Now we will talk about what you must do when you begin to make the true road.  
We will talk about this in four (4) parts:

- A. How to begin a bench cut road (read pages 34 to 47).

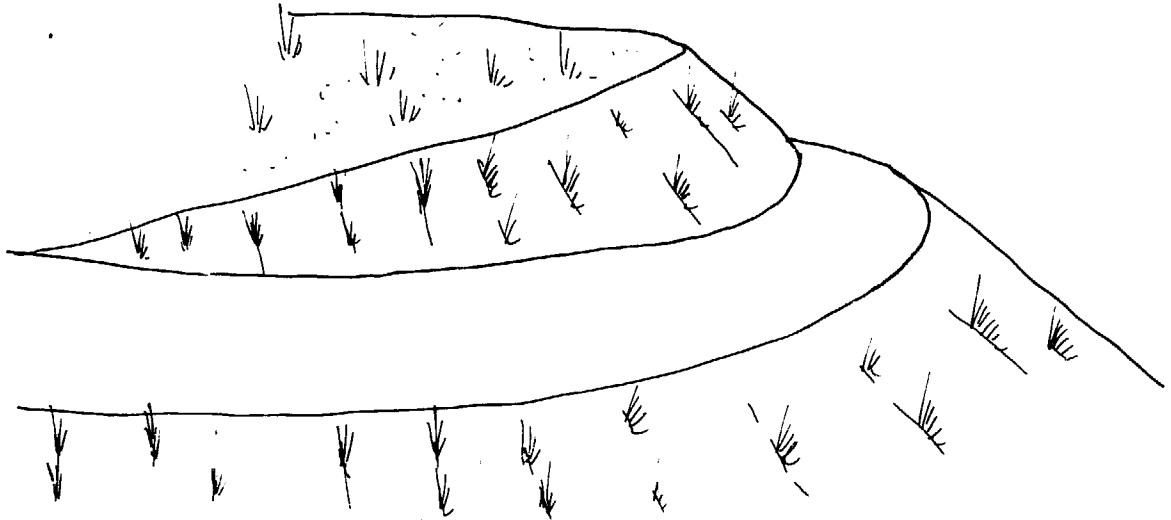

- B. How to begin a road on flat country or country that is nearly flat.  
(read pages 48 to 54).

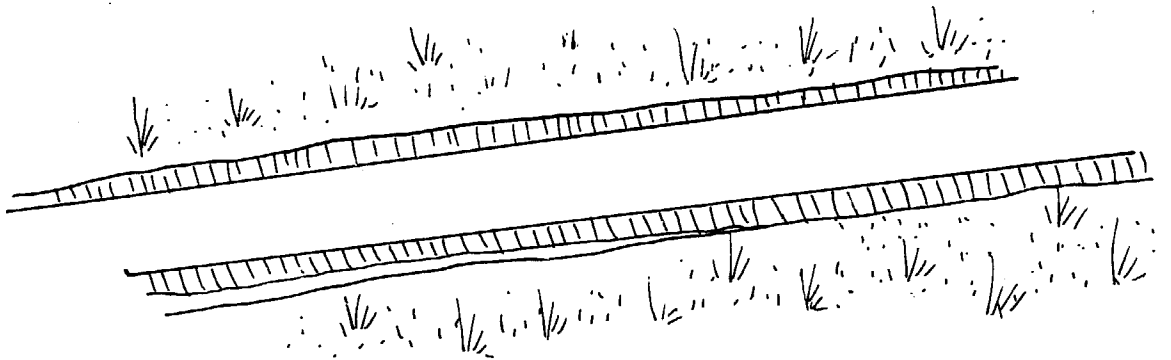



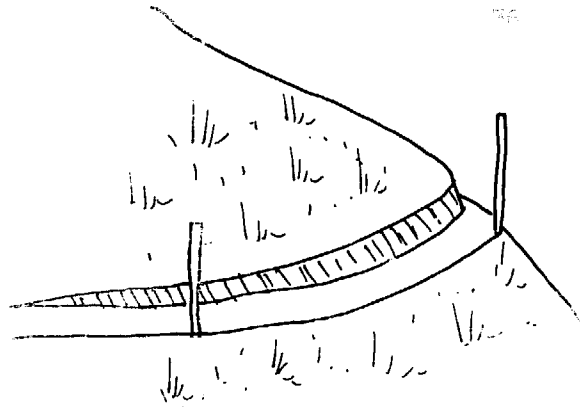

This is a foot track.

It must not be less than 5 metres.

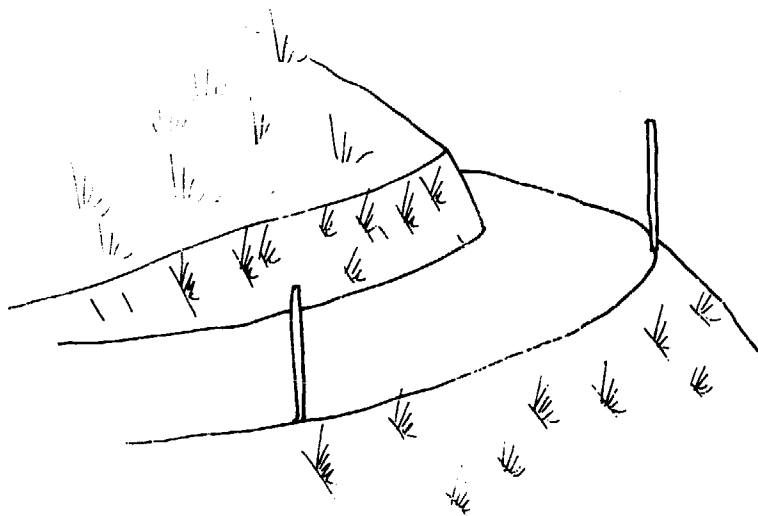

Bench cutting in from the  
foot track.

Here is a picture showing that the solid bench is five metres wide  
with a lot of ground dumped down the hill beside the road:

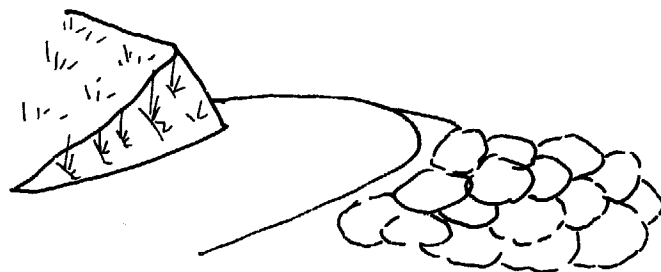

"Spoil" is ground that was  
dug and dumped over the  
edge of the bench.

The solid bench must be at least five metres wide. It does not  
matter how wide the spoil is.

2nd Rule: For unstable country where there is plenty of bush.

Do not cut down big trees. The roots of the trees hold the ground and make the ground more stable. Also the trees stop stormwater from running down the hill fast in big rains. Do not cut the big trees. Cut only the little bit of bush close to the road where it might grow over the road. But read 3rd rule about trees at the top of a cutting.

3rd Rule: For stable and unstable country where there are trees near a cutting.

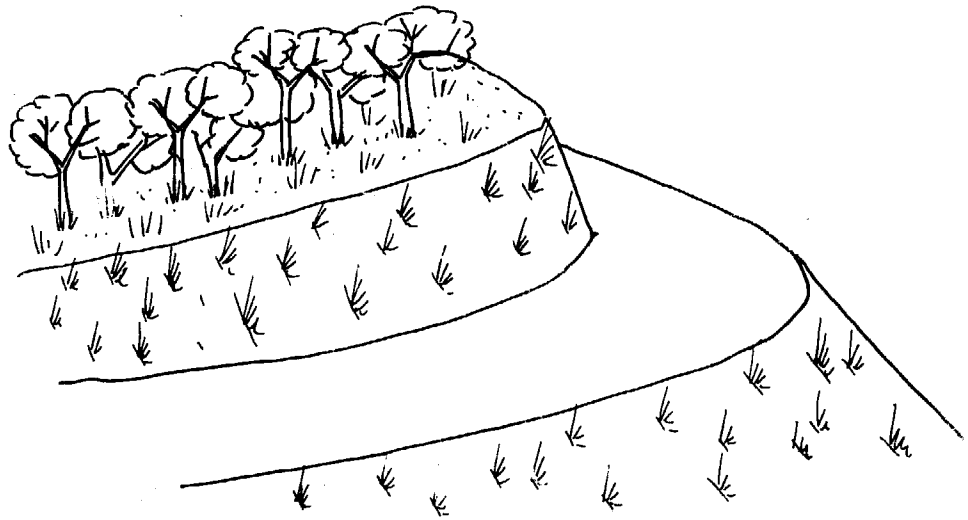

You must cut down every tree that is less than 3 metres from the top. Why? You must cut them down because some of the roots will be cut when you make the cutting, and the trees might fall down.

4th Rule: For unstable country where there is no bush.

Suppose your road goes through country where you can see the landslides have happened. You must plant bush to hold the ground together. Bamboo and Casuarina trees are good to plant in places like this because they grow quickly.

## 2. Cutting the bench.

Now the bush is cleared, you can start to cut the bench.

(a) How wide do you cut the bench?

You must cut it flat into the hillside from the foot track, for at least 5 metres.

- C. How to begin a road that goes through swampy and low-lying country.  
(read pages 54 to 59).

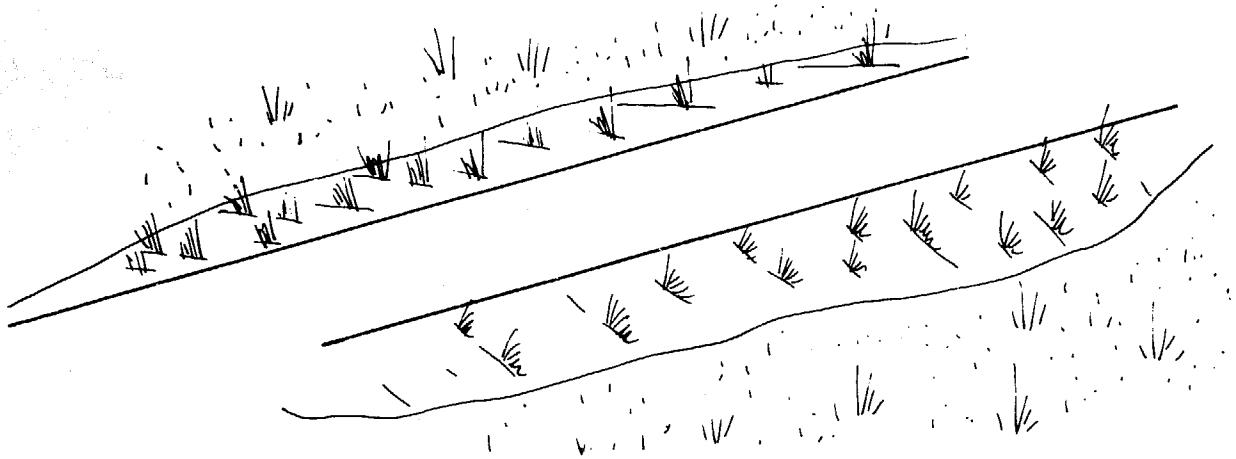

- D. Other information about how to begin to make a road.  
(read pages 59 to 74).

A. HOW TO MAKE A BENCH-CUT ROAD

1. Clearing the bush.

Firstly, you must clear the bush along the place where the road will go. Why do you do this? You clear the bush so that the sun can shine on the road and make it as dry as possible. BUT suppose the country is not stable - suppose a lot of landslides fall down the hillside in that area. Where the country is not stable, you must leave trees in the ground together to prevent landslides.

There are four (4) rules about clearing the bush:

1st Rule: For stable country where landslides do not happen.

Usually, you can let the sun shine on the road to dry it by clearing a little bit of bush (or overhanging trees) below the road. Above the road you must clear the bush at least 10 metres from the centre line of the road. All big trees that grow less than 30 metres from the centre line above the road, and hang over the road, should be cut down. If you have plenty of workmen you can clear all the bush, big trees and little trees, back to 30 metres from the centre line.

Suppose you cannot make the solid bench five metres wide. You might find a big rock in the hill or something like that.

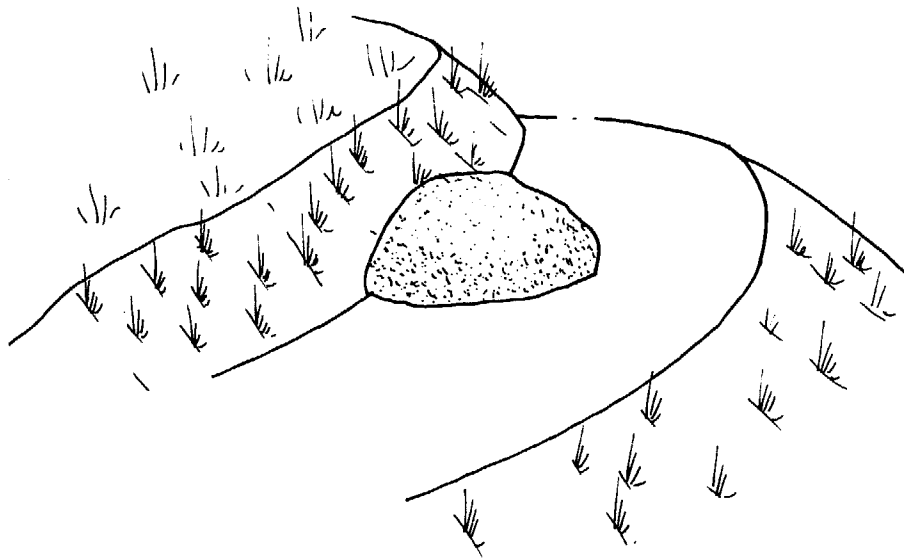

Suppose you meet some kind of trouble like that, you must write to the Local Government Supervisor in your District straight away. He will help you and give you advice. You must not build the road less than five metres wide. This 5 metres is the "absolute minimum".

It is better to build the road 8 metres wide. That is a good measure, called the "preferable" or "desirable" standard.

Will heavy truck use the road straight away when it is finished?

If the big trucks use the road, you should build the better road that is 8 metres wide. A road 5 metres wide will not be good enough. Read Section 6 "Upgrading", and build a road like page 75 says. A road made that way will be a good road for heavy trucks.

(b) Keep the grade or steepness of the road even.

All the time you are beginning to make the road, you must make sure that the grade or steepness of the road between the pegs is even.

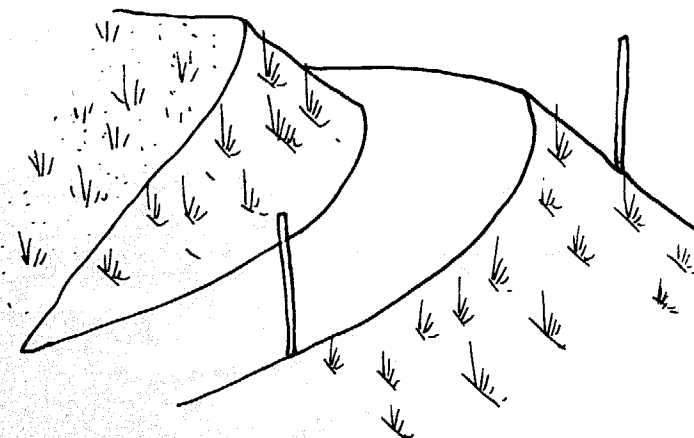

Road with uneven gradients between pegs.

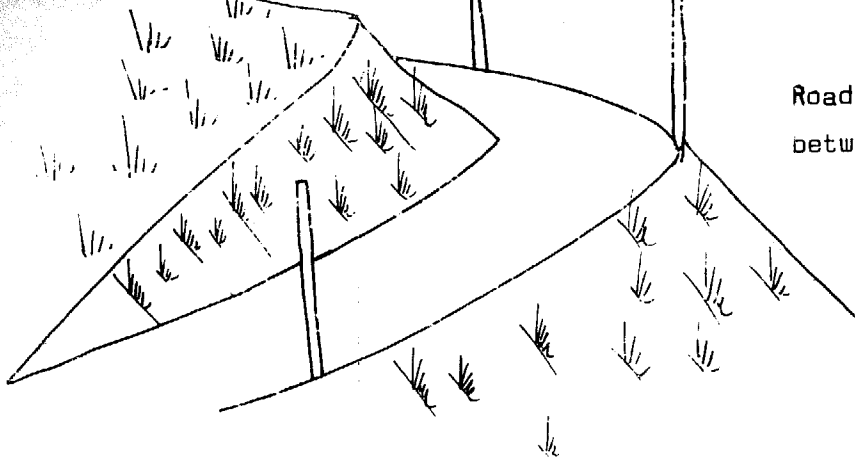

Road with even gradients  
between pegs.

Usually, the best way to make sure of this is to use boning rods the way I told you on page 29.

Suppose the surveyor's pegs say you must cut in one place. You must cut all around the peg.

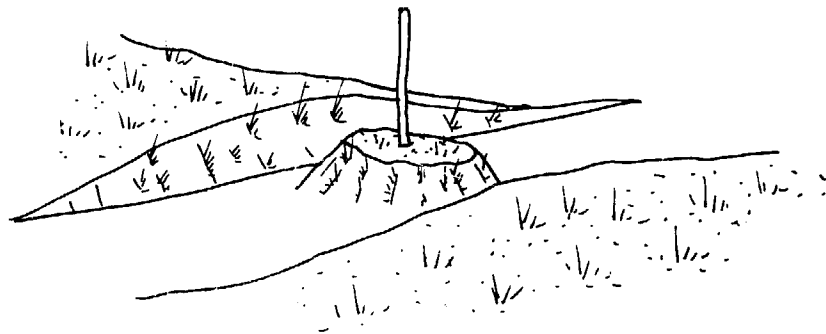

You do not cut the ground where the peg is. The peg stays there until you have cut to the measure. Suppose the peg says  $-3m$ . You do not cut the ground where the peg is, but you must cut away the ground all around the peg until you can measure down 3 metres.

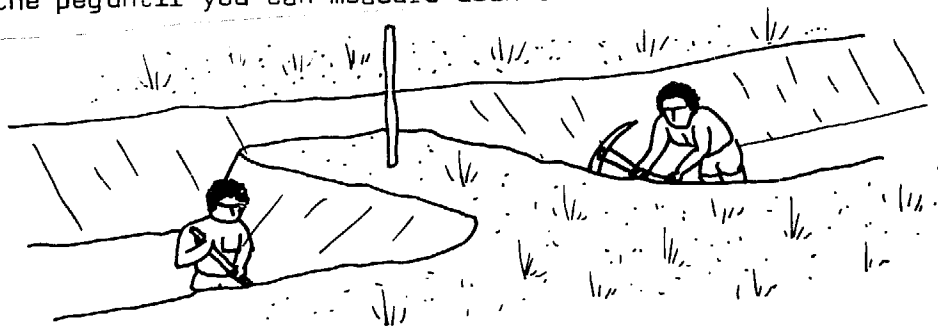

When you can measure 3 metres from the ground level on the peg to the bench, then you can cut away the ground where the peg is.

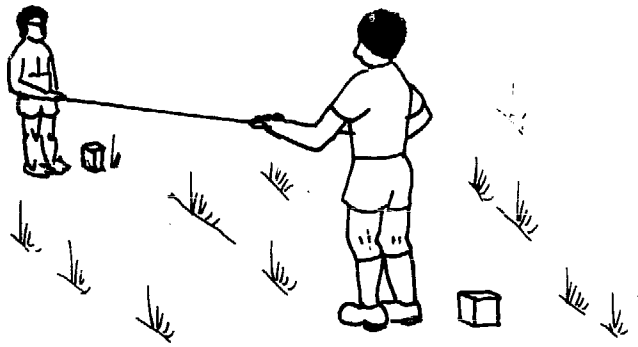

This work has to be done by a surveyor, or by a roads supervisor who knows how to set out pegs for earthwork.

### 3. Camber and drainage.

Now the first bench has been cut, you must do two things straight away. First, camber the road. Second, cut drainage channels straight away. Why must you do these two things straight away? Because even one heavy rain can spoil your road. One big rain can wash away the top ground of the road and make holes and cuts in the road.

#### (a) Camber of the Road

If you go to the Council Road Overseers Course at Embogo, you will learn how to use the template. With the template, you should set out a camber 1 in 24.

Suppose you do not know how to use a template. You must make the road curve like the road in this picture.

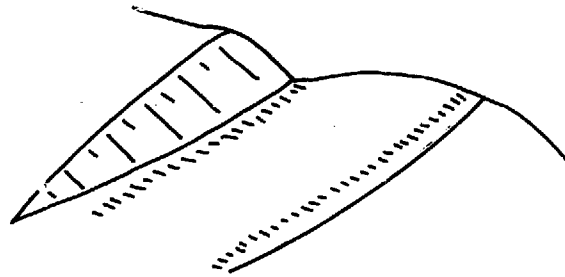

Rainwater can run off this road. The water will not spoil the road.

Suppose you fill to the top of the peg. You must put in a new peg, the place at the top of the peg is the ground level for the new peg. The new peg is measured. Say this measure was 1.3m, again you calculate the measure to the top of the fill. This new measure would be  $2.3\text{m} - 1.3\text{m} = 1.0\text{m}$ . of more fill above the top of the new peg.

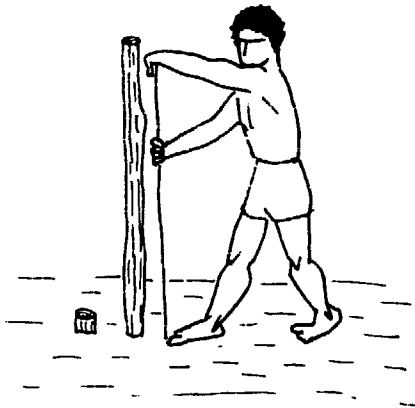

(b) Measure height of new  
peg: 1.3 m



Fill to the top of this peg.

You fill again to the top of the new peg. Now you must fill 1.0m more from the top of the new peg. Put in one more peg and measure up 1.0m from the top of the peg you have just filled to and put a mark on this new peg.

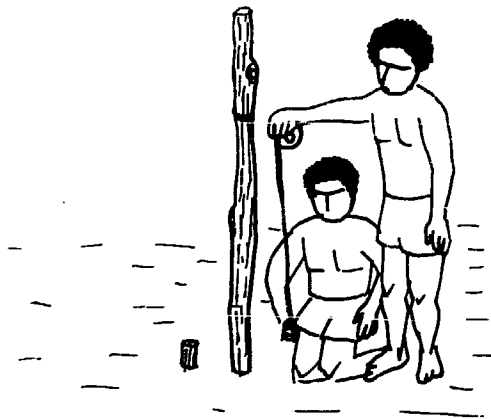

(c) Put mark on peg

(c) Machine Earthwork

If the cut or fill is being done by machines such as bulldozers, pegs cannot usually be left in this way. They get knocked out by the machine. Extra pegs that are called "offsets", have to be set off the road. You measure from these offset pegs.

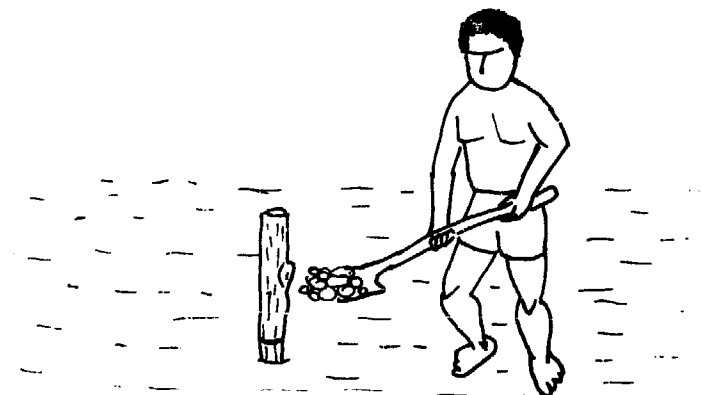

Fill to the mark

Suppose the peg shows that you must fill the place where it stands.

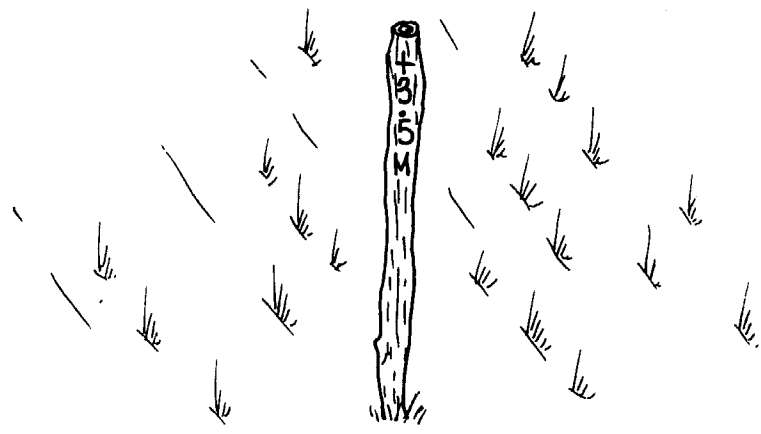

This peg in the picture shows that you must fill that place until you can measure up 3.5m. How can you do that? Suppose you throw ground on the peg, you will cover the peg. You cannot measure from a peg that is covered. So this is what you do: you measure from the ground level of the peg to the top of the peg. Say this measure was 1.2m. You calculate the measure the top of the fill that you want. This measure would be  $3.5\text{m} - 1.2\text{m} = 2.3\text{m}$ . of more fill above the top of the peg.

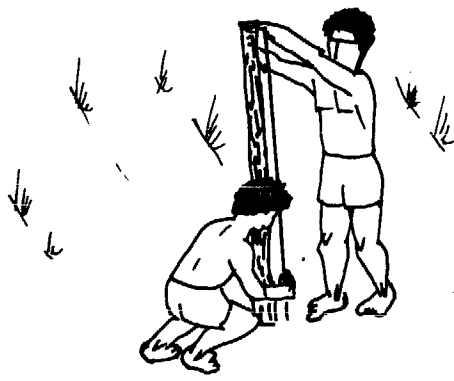

Measure height of this peg.  
This measure is 1.2 m.

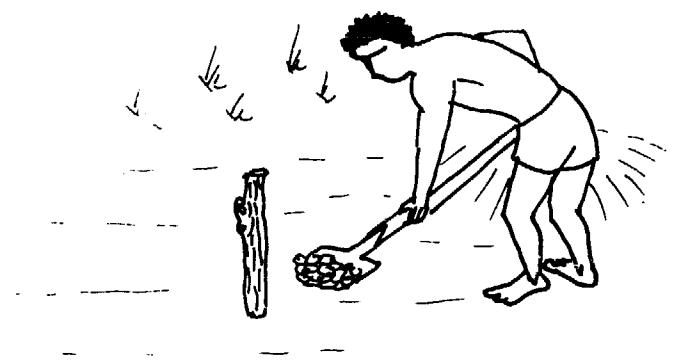

Fill to the top of the peg.



(b) Side drains.

You must hurry up and make drains along the sides of the road. These drains are called side drains. They are sometimes called table drains. You must cut them like the drains in this picture.

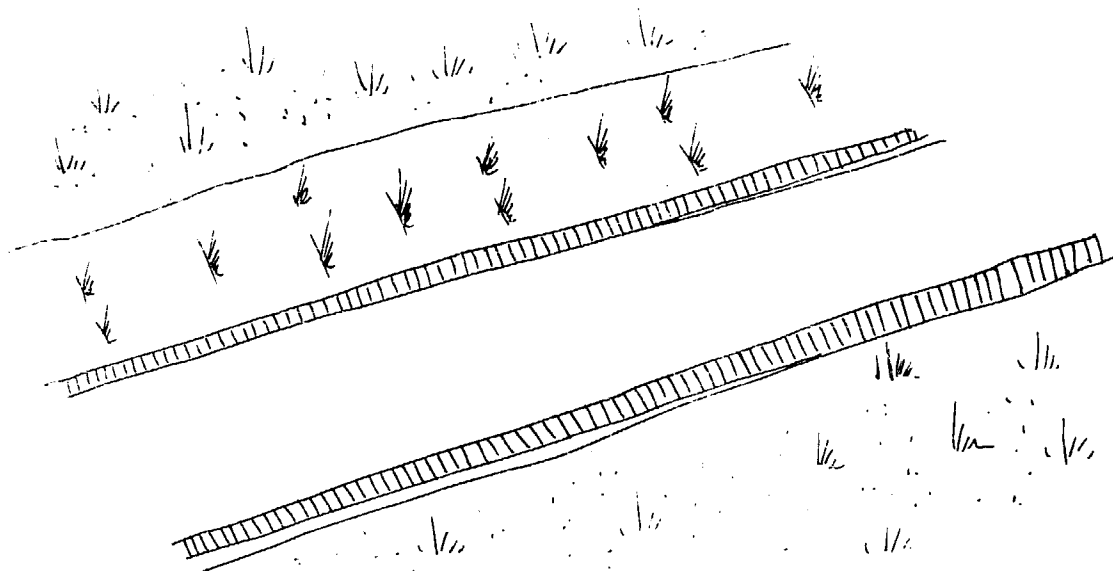

(c) Relief drains.

Also you must cut relief drains to take water away from the side drains.

How many relief drains do you need?

If you go to Embogo you will learn how to measure gradient. When you know how to measure gradient, or steepness of a road, you can use this information to work out how many relief drains you need: Suppose the gradient is 12%, you must cut a relief drain every 40 metres.

Suppose the gradient is 10%, you must cut a relief drain every 60 metres.

Suppose the gradient is 8%, you must cut a relief drain every 80 metres.

Suppose the gradient is less than 8%, you must cut a relief drain every 100 metres.

If the ground is high on one side of the road, you cannot take away the water in a drain on that side. Then you need to put a culvert under the road. This culvert will take away the water. If you cannot measure gradient, these pictures may help you.

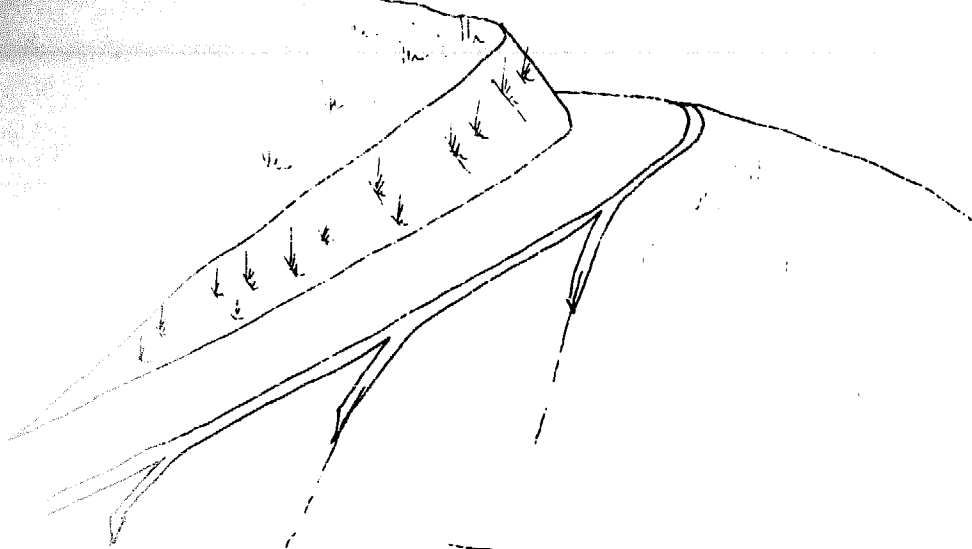

Picture 1.

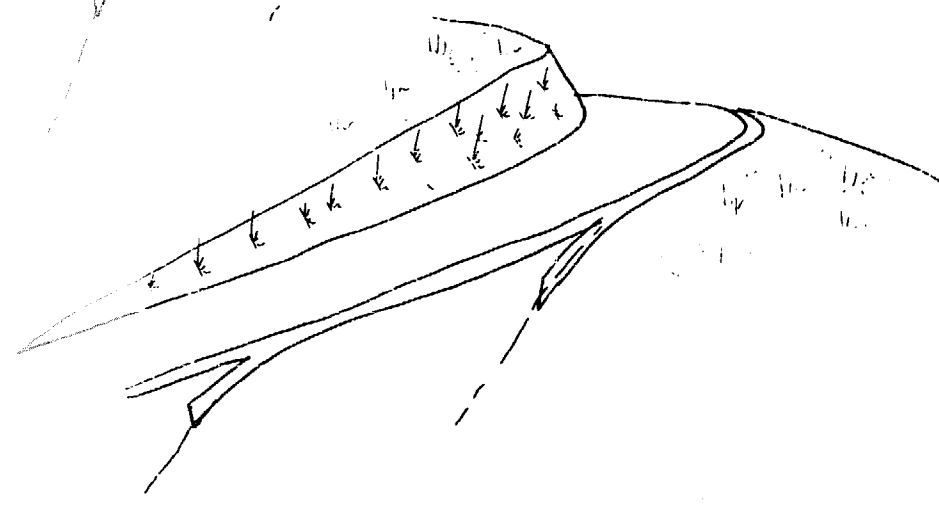

Picture 2.

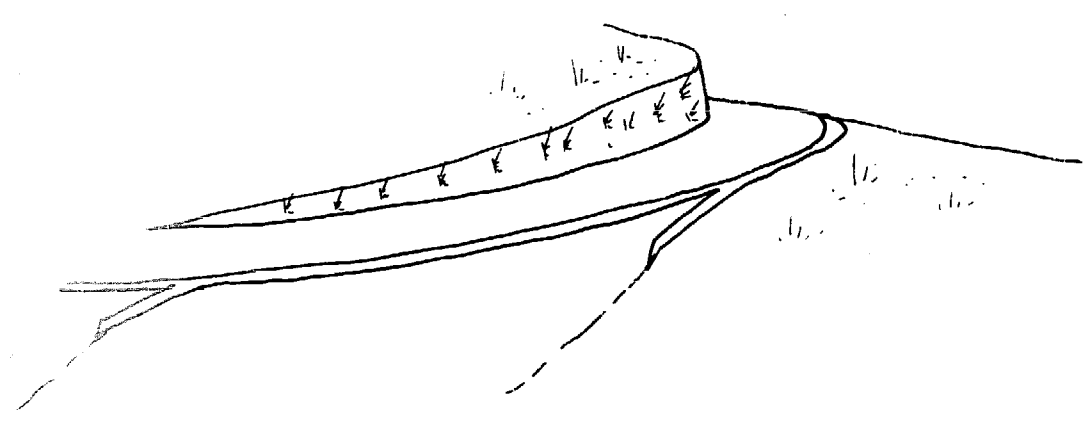

Picture 3.

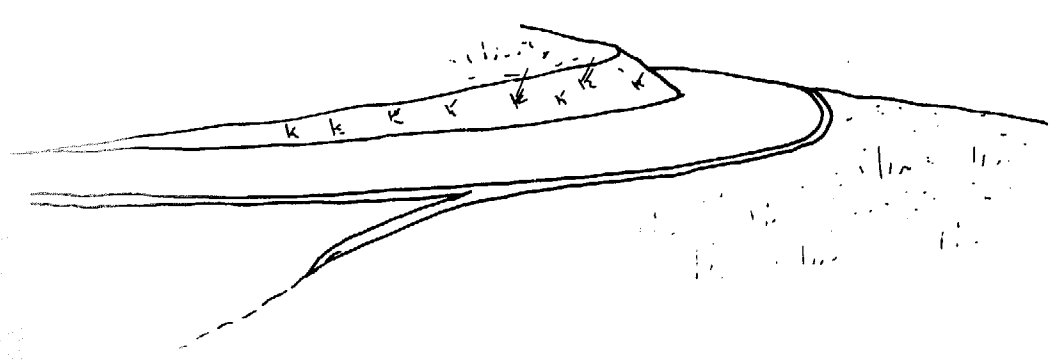

Picture 4.

(d) Catch drains.

When do you need a catch drain?

When a cutting is 3 metres high, or higher, a drain should be dug along the ground above the cutting. This will stop water coming down the hillside onto the cutting.

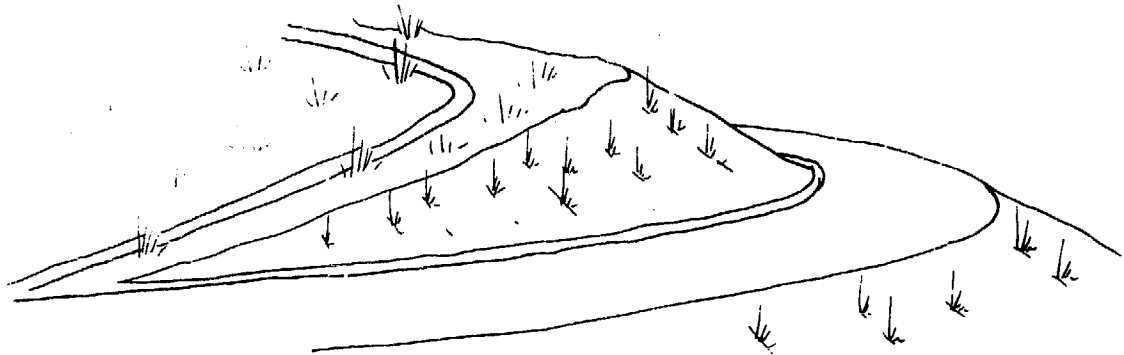

Where do you dig the catch drain?

If the cutting is 3 metres high, you dig the catch drain 3 metres back from the top of the cut. If the cutting is 7 metres high or more, you dig the catch drain 7 metres back.

What would happen if you did not dig a catch drain?

If there was no catch drain, water running down the hillside would wash away the face of the cutting, and could make it all slide down onto the road, like this:

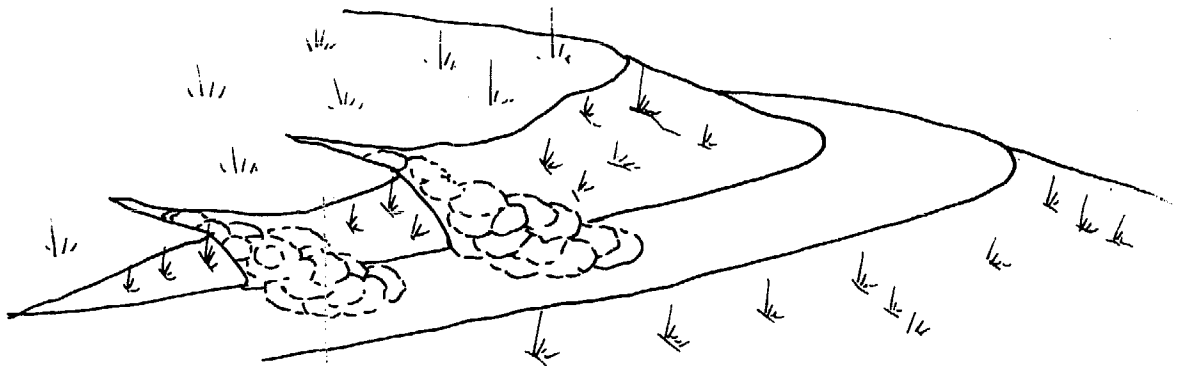

This is important: Now you have cut the bench, cambered the road and cut the side drains, the relief drains and the catch drains. All right. Now the important thing:

When the first heavy rain comes you must go straight away and look at the road. Suppose you see some places where the stones or fill have been washed away. This washaway (also called scouring) means your drainage is not good. You must start to make the drainage good straight away. You must make the camber of the road good again and you must cut more relief drains to keep water away from the road in the next big rain.

4. Batter.

This picture shows what we mean by "batter". Batter means the slope of ground across the road, where it is cut or filled. Batter is measured as so many metres vertical (up and down) to each metre horizontal (on the flat).

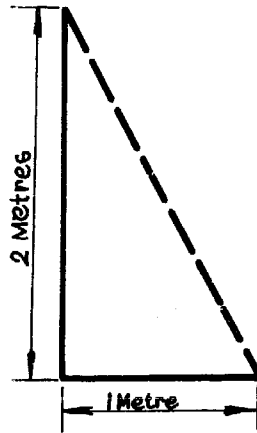

Usually, a cutting should be dug with a batter of 2 to 1, as in the picture. If the batter measures 4 metres up and down, it should be 2 metres on the flat and so on.

But if the road is in very mountainous country, see if the ground is strong enough to stand up at a steeper batter, such as 4 to 1 (nearly vertical).

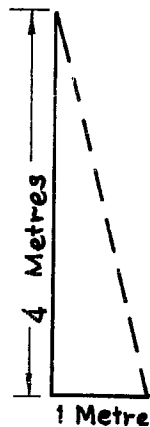

If it will stand up, and the road can be built this way, then a lot of cutting work can be saved.

If the road is built with very steep batters, some parts might fall down. These parts should be quickly cleared so that the drains do not get blocked and make washouts on the road surface. Suppose you have a high cutting, with a cut 7 metres or more, then you must use the right batter, 2 to 1. At every 7 metres of height from the bottom, a step 1.5 metres wide must be formed, then the batter goes on up at 2 to 1.

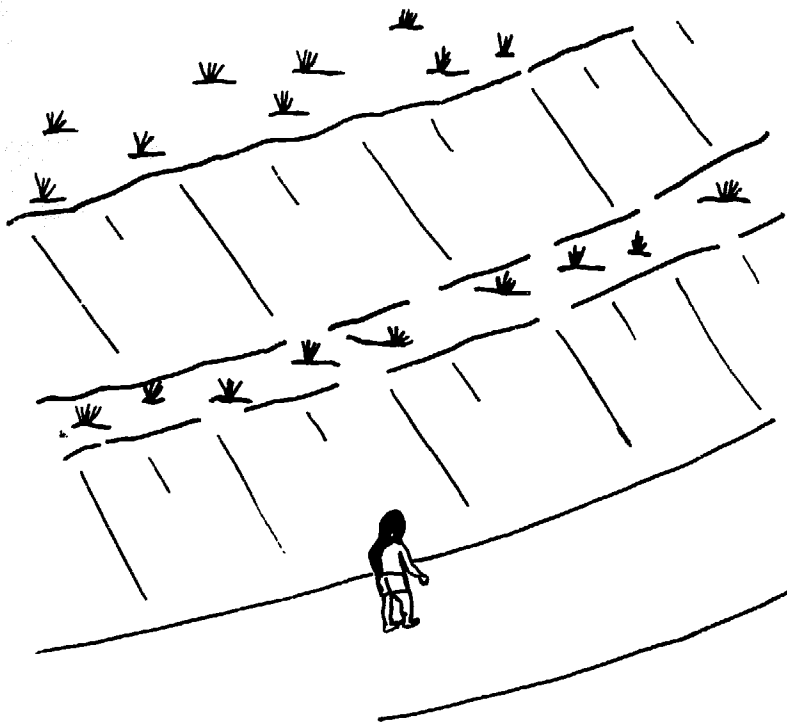

The batter at the bottom of this picture is 3.5m on the flat because the cutting is 7m higher to the step. Then the step is 1.5m wide. Then the top of the cutting is 6m high so the top batter is 3m on the flat.

For cutting batters, especially many high ones, you should use a template like that shown before (page 30).

#### Hairpin bends.

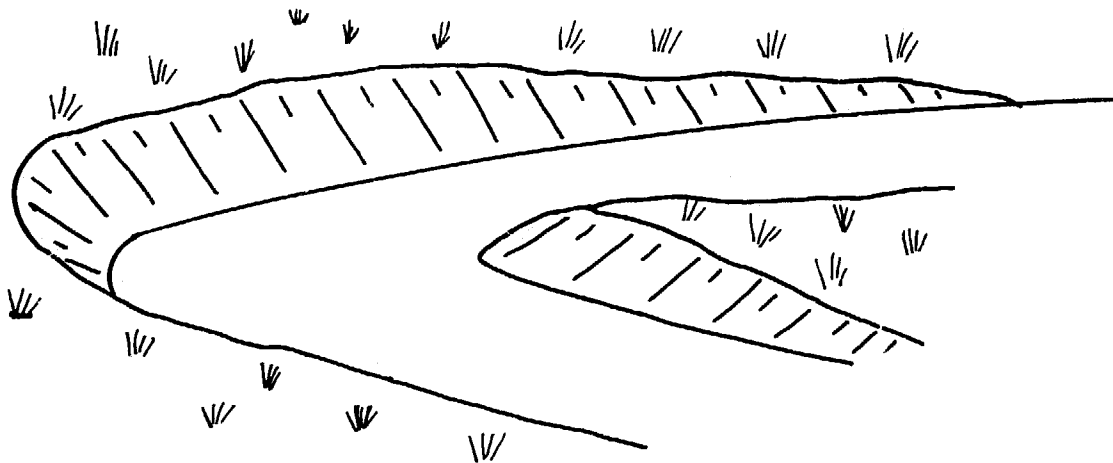

When the surveyor marks the route where the road will go, he tries to have no hairpin bends. Hairpin bends are not good. But sometimes the surveyor has to use a hairpin bend. Then he marks the route very carefully so that a tractor and trailer can get around the bend without stopping. Suppose the tractor is turning round the bend, it goes in a circle of radius 15 metres.

The road at the inside of the bend must be graded smoothly, so there is not a sudden bump in it. This means the outside of the bend must be almost flat. The normal grade of the road does not start again until the road goes straight in the new direction, after the hairpin bend. Drains must be built carefully round the hairpin bend, so that water does not wash away the pavement.

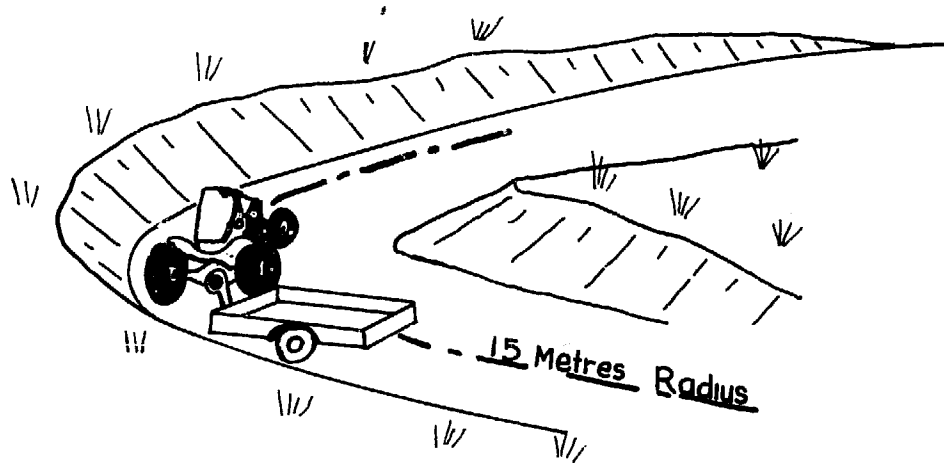

Bench cut roads can give a lot of trouble. They are hard to make properly so that trucks can use them all the time. Also, you have to work a lot to maintain them. BUT you will make the bench cut road as good as possible for trucks, and as easy as possible to maintain, if you construct them as I have told you.

B. HOW TO CONSTRUCT A ROAD ON FLAT COUNTRY OR COUNTRY THAT IS NEARLY FLAT

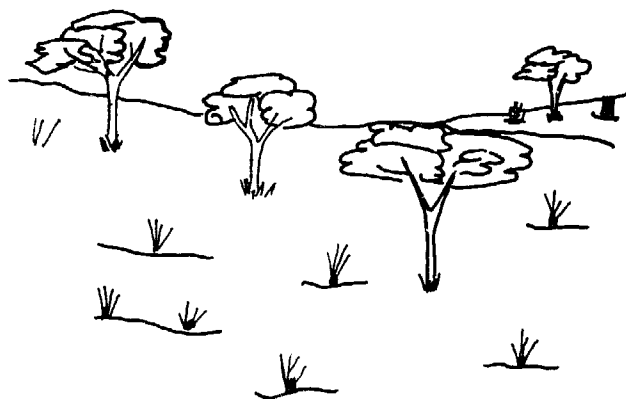

This picture shows country that is nearly flat. Engineers say it has a "very low crossfall".

This section tells you how to construct roads that are not bench cut. A road along the ridge top of a mountain is not bench cut. You will use this section for constructing ridge top roads.

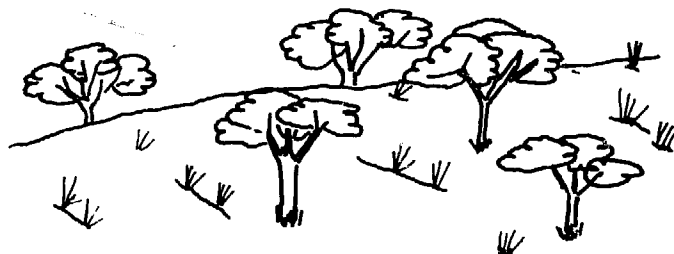

A ridge.

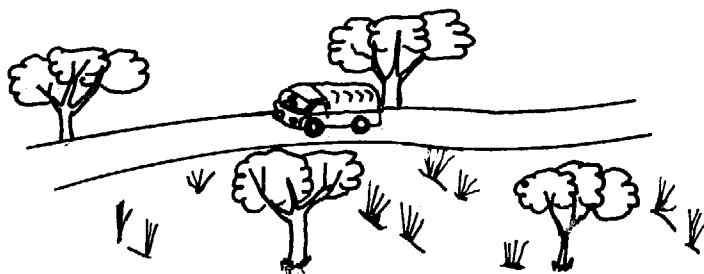

Ridge top road.

1. Clearing the bush.

USUALLY, you clear all the bush for 10 metres from the centre line of the road that you are beginning to build.

You cut down the big trees that are less than 30 metres from the centre line of the road.

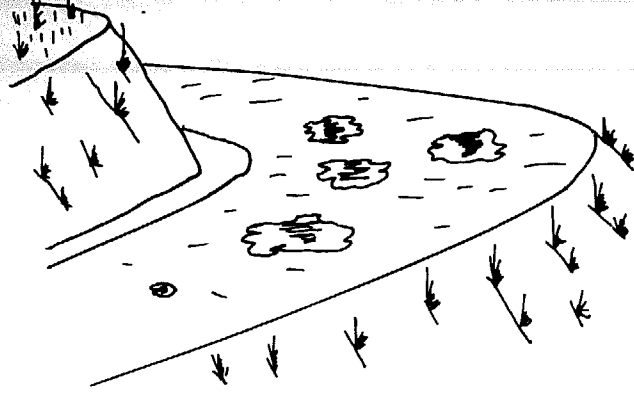

(b) This road is too flat. Water has collected in puddles. The road surface is not good (Read page 12).

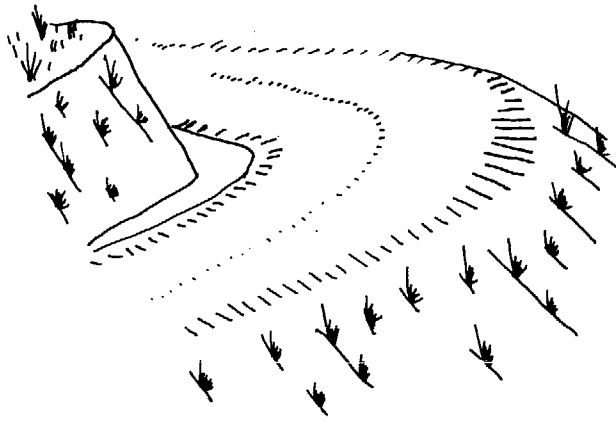

(c) This is a good camber. The storm water runs off easily, water cannot collect in puddles or holes.

#### 4. Formation of the Road - side drains

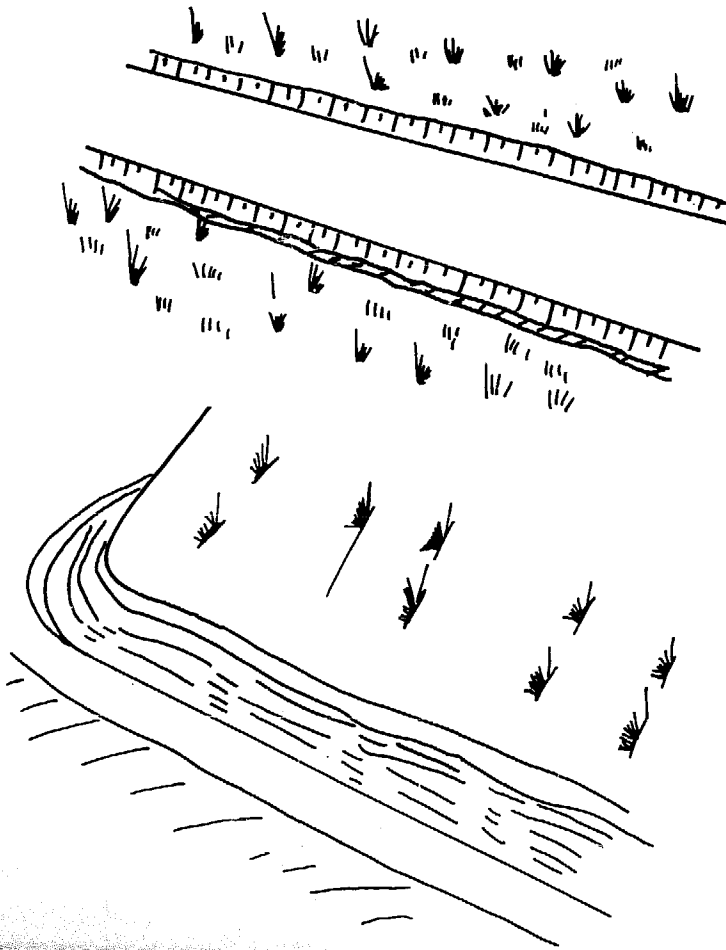

The side drains carry away water that runs off the road. They also carry away water that flows towards the road from the area around.

The side drains must be big enough to carry away all this water. (Side drains are also called table drains).



All the topsoil must be taken away from where the road will be.

Do not use topsoil to build up the roadway. Topsoil is too soft. Usually, topsoil is not more than half a metre deep. (500mm).

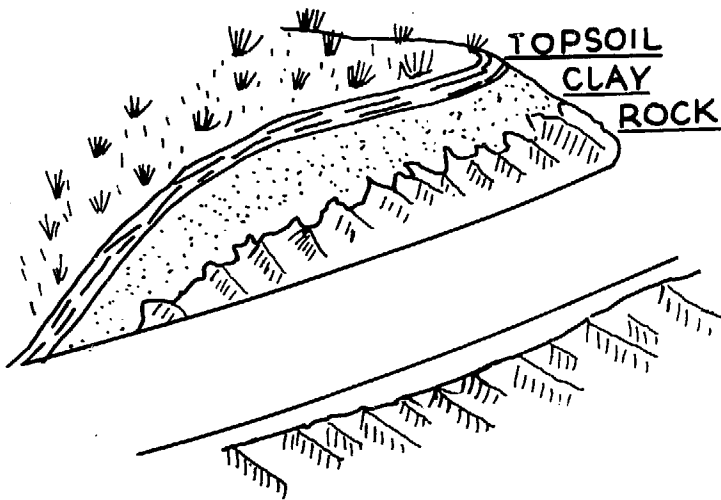

Cross-section of ground.

This picture shows a cutting. On top of the hard ground or rock is some topsoil. Sometimes the topsoil is only 100mm deep.

Sometimes it is 400mm deep. It is not often more than half a metre deep.

If it is less than half a metre deep, you must clear it all away before you begin the road.

Suppose you had to build the road in a place where the topsoil is very deep.

What do you do? You cannot clear it all away. You cannot make the road on topsoil. It is too soft. All right, you must carry loam or sand or stone to the place to put on top of the topsoil. You must put on one lot of loam or sand or stone and ram it down very hard. A big Council may have a tractor and roller to ram it down hard. A small Council may have to get all the people to dance on the place to ram the material down hard, or they may use rammers that you can read about on page 66. When one lot of loam or sand or stone is rammed down hard, you must get another layer and ram it down hard. Each layer must be no more than 150mm deep when it has been rammed down. This stone or sand or clay material makes a "pavement" when it is rammed down hard. When you finish making the pavement, the pavement must be 300mm deep or even more deep. The pavement must not be less than 300mm deep.

The road must not be less than 5 metres wide. Suppose you can make the road 8 metres wide, this is better.

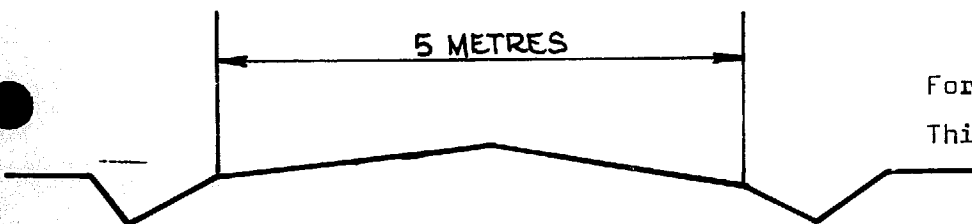

Formation 5.0 metres.

This is good.

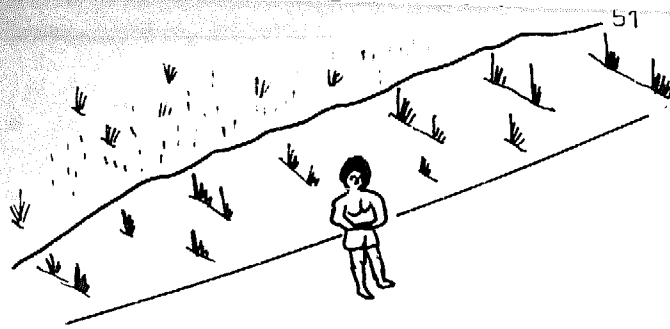

Formation is 8.0 metres.  
This is very good.



Now you must use boning rods the way I told you on page 29. The boning rods will help you to make the grade evenly between the pegs.

### 3. Formation of the road - camber

Now you must camber the road straight away, before rain comes. If you go to Embogo Training College, you will learn how to use a template. Use the template to set out a camber of 1 in 24. If you do not know how to use a template you can use these pictures to help you:

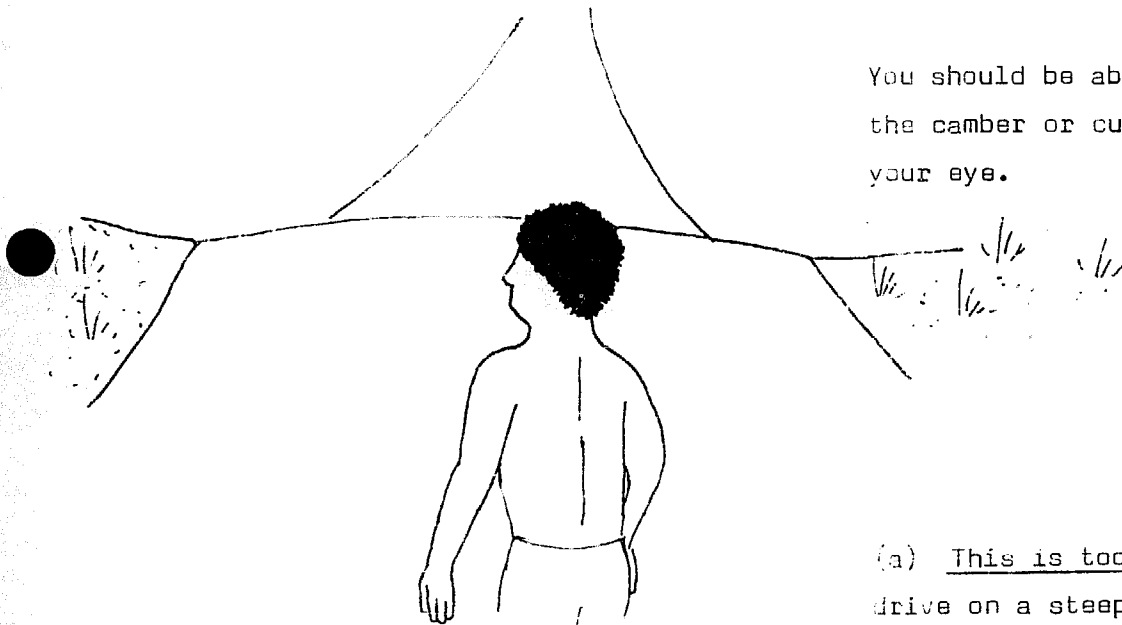

You should be able to see the camber or curve with your eye.

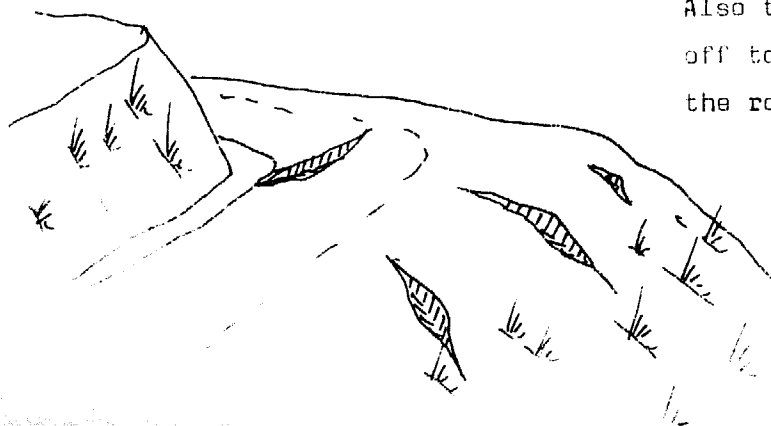

(a) This is too steep. You cannot drive on a steep camber like this. Also the storm water will run off too fast and this will scour the road.

BUT suppose the road is on a razor back ridge, you must not clear trees and bush below the ridge top. If you clear these trees and bush, the ground will become unstable and you will make landslides fall.

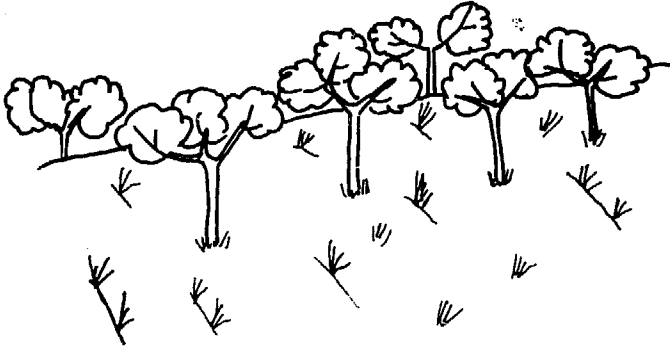

This picture shows a razor back ridge. You must not cut down the bush below the flat top of ridge top where the road will be built.

2. Clearing the topsoil

Next, you have to take away all the topsoil. Topsoil is the soft ground that plants and trees grow in.



These two pictures show where your road will be

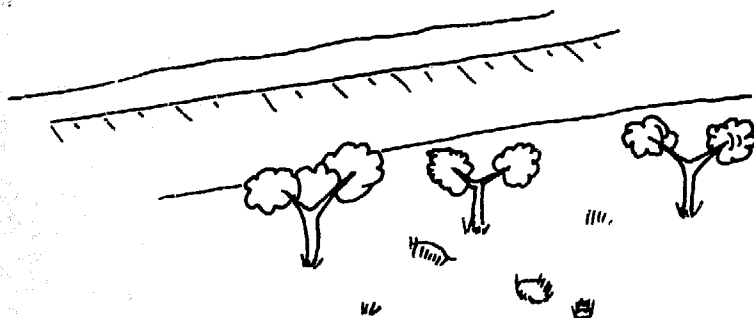

5. Formation of the Road - relief drains

Relief drains help side drains.

How many relief drains do you need? Read page 42 .

Where do you put the relief drains?

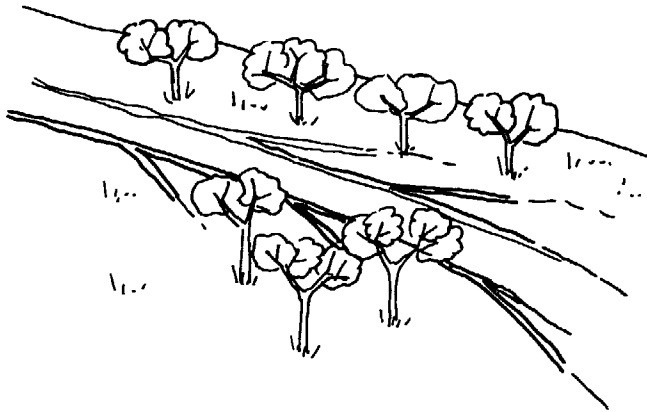

This picture shows where you dig the relief drains.

The relief drains should be at an angle of 45 degrees from the centreline of the road.

What do you do if you cannot get relief drains on both sides of the road?

Sometimes the surrounding area makes it difficult to have the relief drains at an angle of 45 degrees from the centreline of the road; then you should follow the natural fall of the ground.

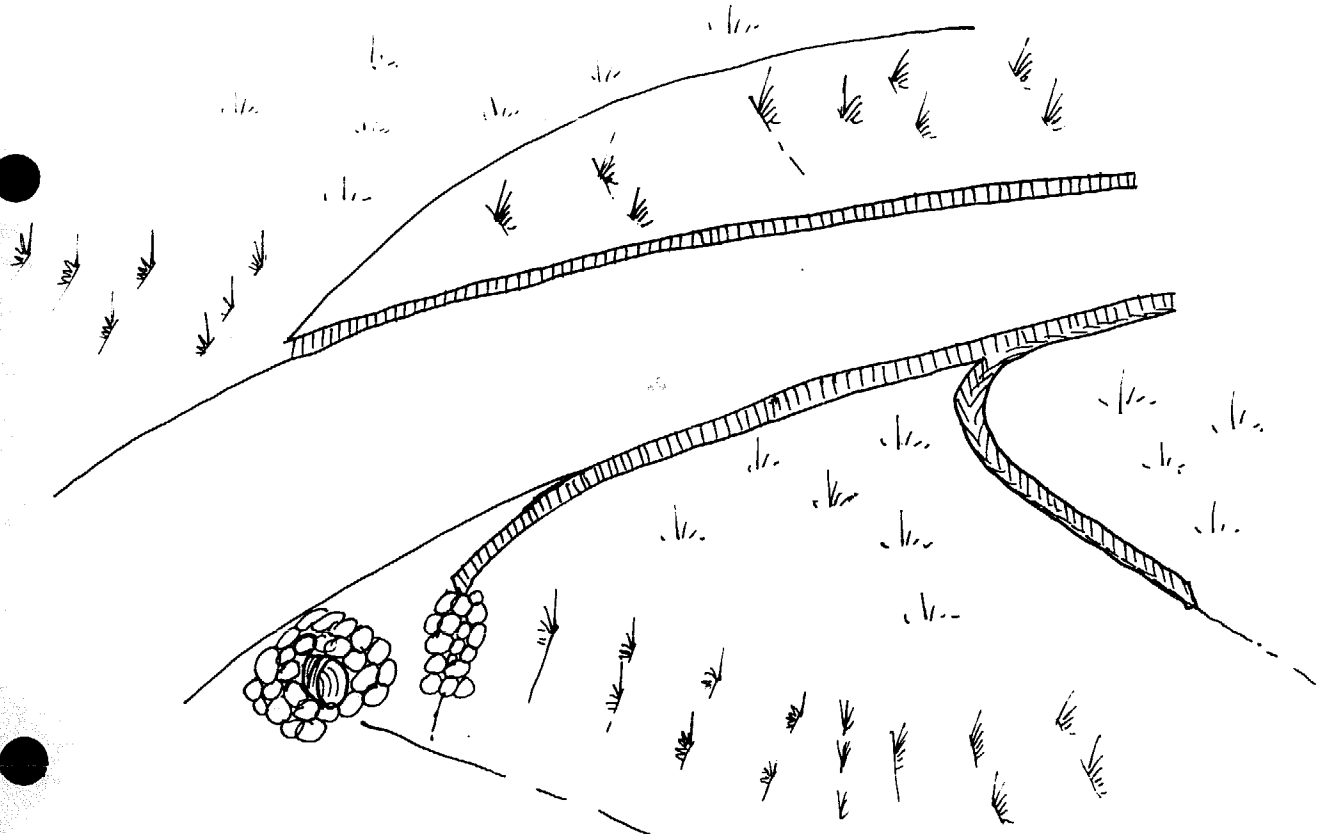

If relief drains cannot be built from one side of the road, because all the ground on that side is higher, then you have to put culverts under the road. The water will go through the culverts and away in the relief drains or the gullies from the other side.

6. Why do all roads need drainage?

People building a road on a steep hill can understand that they must make good drainage for the road, because the road will fall down if they do not make good drainage. People building a road in flat ground cannot understand this so clearly. People building a road in flat country often do not form the road properly or give it good drainage because they think the road does not need good camber and good drainage. This is bad thinking. Many roads in Papua New Guinea cannot be used now, because the people who built them did not make them with good camber and drainage. Suppose you build a road in flat country with good camber and drainage, trucks will always be able to use the road and also you will not have to work hard all the time to maintain it.

C. HOW TO BUILD A ROAD IN SWAMPY COUNTRY AND LOW LYING COUNTRY

1. Roads in swampy country are hard to build and hard to maintain.

Do not build a road in this country if you can build it in a different place. It is hard to build a road through country that is swampy or low lying. Also, it is hard to maintain a road in this country. Suppose you must build a road in swampy country because all the country in that area is swampy. Then you must try to get the top of the road as far above the ground water-level as you can.

2. What is ground water-level?

(Ground water-level is also called the water table).

If you dig a hole or a well in the ground the level of the top of the water standing in the hole is called the ground water-level. The closer this is to the ground level, the more swampy the country.

Look at the next page and you will see what I mean.

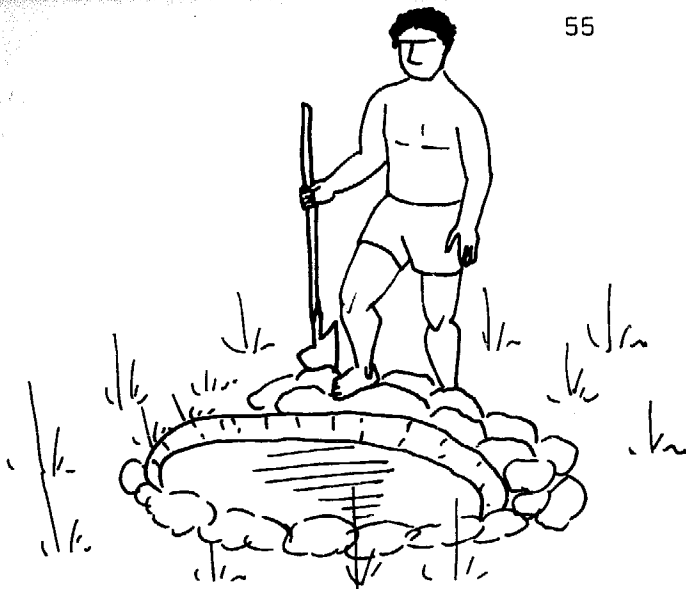

This picture shows the ground water-level in swampy country.

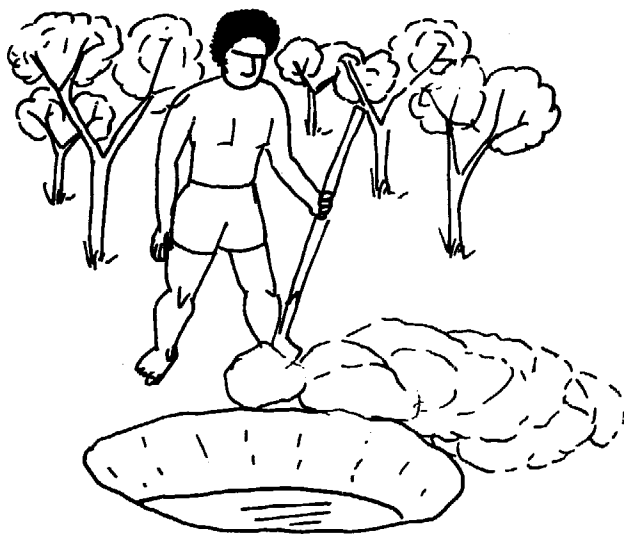

This picture shows the ground water-level in dry country.

How do you construct the road so that the top of the road is above the ground water-level? You do this by constructing big drainage ditches. You also build up the road with the ground that you dig out of the drains. You construct an embankment.

3. How to construct an embankment:

First you clear the bush. You must clear all the bush at least 15 metres on both sides of the centre line of the road so that the sun can get on the ground and dry it as much as possible. You must clear all the big trees for 30 metres on both sides of the centre line of the road.

Second, you make a mat of logs from the bush you cut. You must use trees that measure 100 to 200 mm across the end. This is called the diameter.

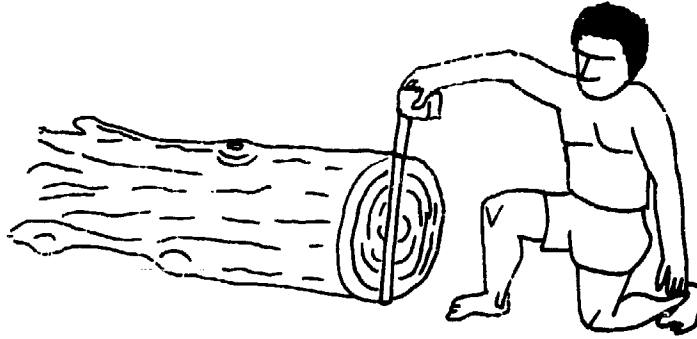

When clearing the bush you must choose good straight pieces of wood. You must cut off the leaves and branches and put the wood down side by side on the place where the road will be.

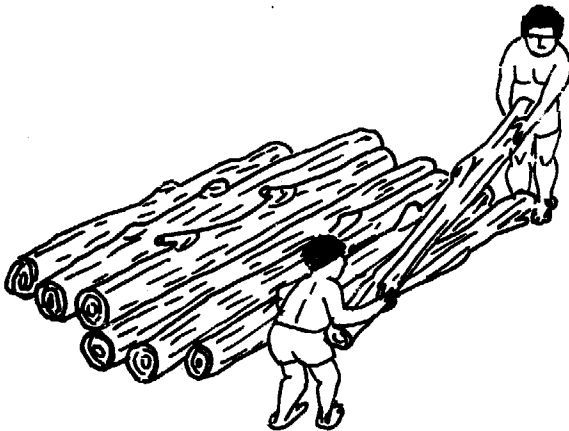

This mat of logs is sometimes called "conduroy".

Third, you must cover these logs of wood with the mud and soil that you dig out of the side drains. If you cover the logs completely, they will not rot or fall apart for many years.

Make sure that the ends of the logs do not stick out. If the ends stick out, the trees will rot and fall apart.

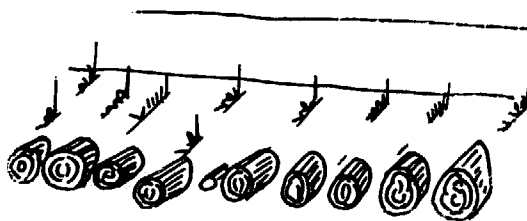

Ends sticking out.

This is bad.

In some areas, these logs may be eaten out by white ants after a few months, unless the logs are below the ground water-level. If this happens, more pavement might have to be put on top of the road to keep its strength. Fourth you must build up the road with fill.

The place where the road will be must be built up so that the formation level of the completed road will be at least one metre above the ordinary ground level.

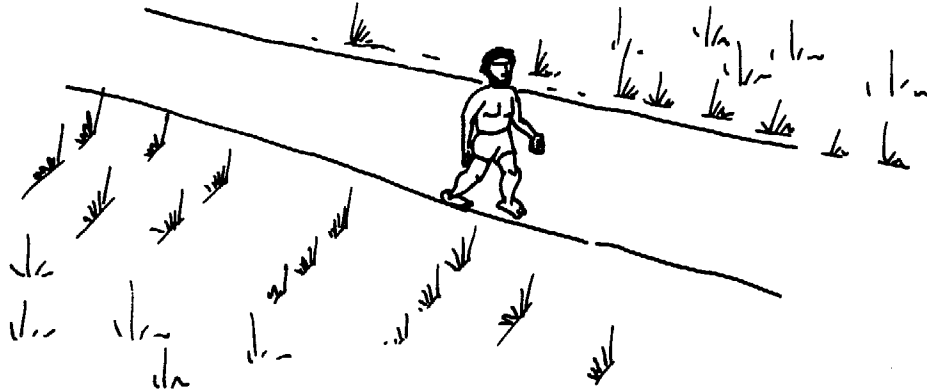

Suppose the ground water-level (or water table) is higher than the ordinary ground level. That means, suppose the place is always swampy. Then the ground-level of the completed road must be one metre above the ground water-level. How deep should the fill be?

An expert has to look at the area to tell you these things. If you must build your road in a swamp, you must ask the Local Government Supervisor to come and have a look at the place to tell you what to use for fill, and how much to use, and how deep to put it. A road through a swamp is like a bridge over water, or like a causeway to an island. The "bridge" must have a strong deep fill that is not wet. This fill must not let trucks break through the surfacing material and fill to the soft wet ground underneath. It is most important to ram the fill material down hard. (Read page 66 to find out how to ram or "compact" material).

The fill must not be wet.

You cannot compact wet material. If you jump on a heap of ordinary ground it will go flat under your feet. If you jump on wet mud, the mud comes up through your toes and around your feet. The wet mud does not go down flat and hard. In the same way, you cannot ram down wet material for the fill. You must dry out the wet material or build up the fill higher above the ordinary ground level before you try again to compact it and ram it down.



The fill must not be too dry.

Suppose the material you have carried to the place for the embankment is too dry, then you will have trouble. If you jump on dry sand, the sand does not go hard and flat. The sand comes up around your foot and toes. But this is not a big trouble. You can sprinkle a little water on the dry material and then you can compact it and ram it down hard.

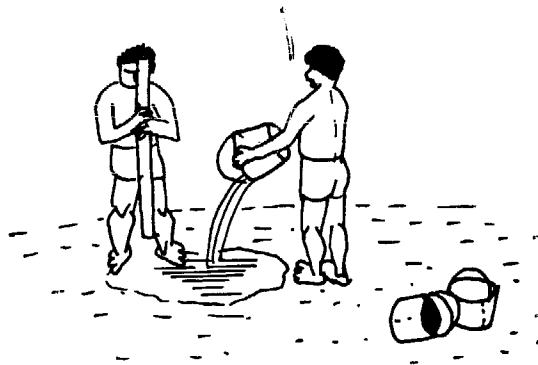

Do not pour on water.  
This is not good.

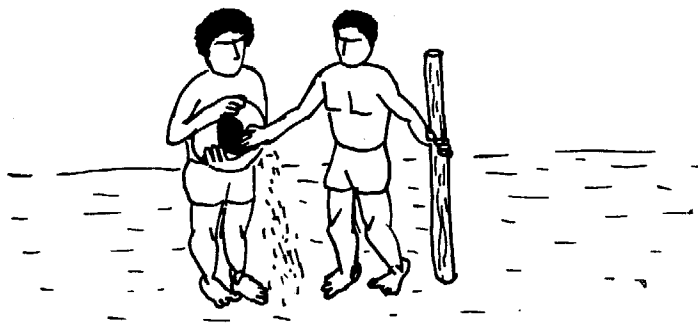

Sprinkle a little water on.  
This is good.

Surfacing Material - What do you use? How deep should it be?

You have to ask the Local Government Supervisor to come and see the area to tell you about fill. He will also tell you what to use for surfacing material. He will tell you how deep the surfacing material should be.

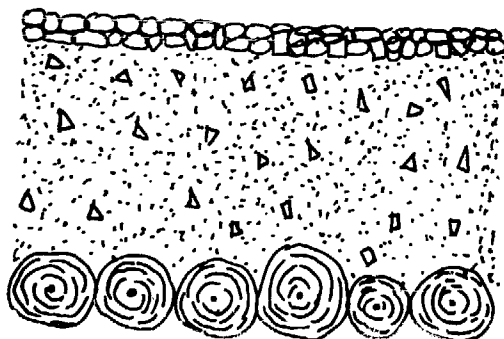

Surfacing material.

You must carry good stone or sand or clay to the place to make this.

Mat of logs covered with mud and ground from ditches or drains.

When you are filling these 2 types of ground, you need to take away the topsoil if the fill is 600mm deep or less. If the fill is more than 600mm deep, you do not need to take away the topsoil.

(iv) You must use good material for fill:

The material must not have any leaves or grass in it, either fresh or rotted (rotted leaves and grass are called humus). This means you should not use topsoil for fill except in swamps.

(v) The fill must not be too wet or too dry.

Suppose the fill is too wet or too dry or has leaves in it or humus in it. Then you cannot compact it. You cannot ram it down hard. How do you find out if the fill is too wet or too dry? Suppose you do not know whether the fill is too wet or too dry. Try it. If you can ram it down hard, it is okay. If it is too wet to ram it down hard, you can leave it loose, and turn it to let all of it dry out. Then you can ram it down. If it is too dry you can wet it a little bit by sprinkling water on it.

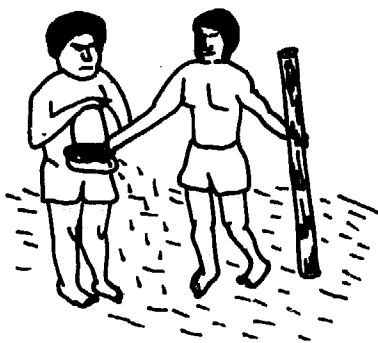

Sprinkle a little bit of water on the ground like I told you about on page 58.

(vi) Put down the fill in layers:

You must put down the fill a little bit at a time. Put down a layer that measures 150mm deep. Then ram it hard. Get poles of wood that measure 50mm across the end. Get a lot of men to use these poles as rammers.

When one layer is compacted and hard, put down another layer 150mm deep, do the same thing again.

See the picture on the next page showing men ramming fill with poles.

First you must keep the steepness (or grades) smooth and even between pegs. You do this with boning rods or a template. Read page 29 to find out how to make boning rods and how to use them. Remember that you must leave the pegs in the ground until the cut and fill are finished.

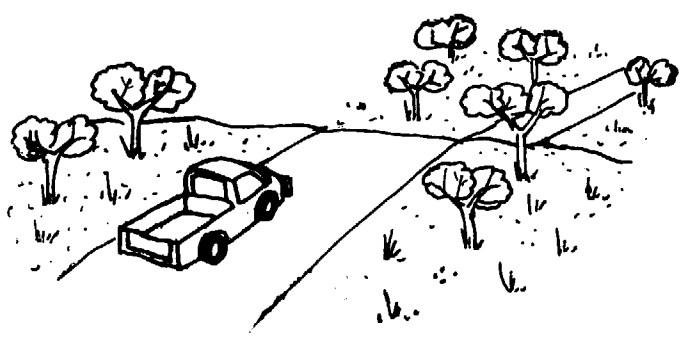

This picture shows curves in the slope of the road. These are called vertical curves.

Now you must construct vertical curves (curves in the slope) at the places where the road has a crest.

You must also construct vertical curves where the road has a dip.

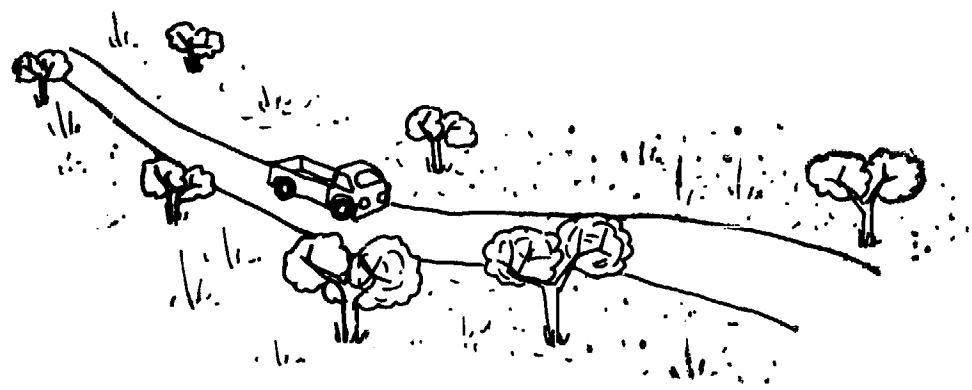

You must look at the way the slope changes, and build a smooth curve. This is not hard work, but the road will be much more safe when you fill in the places where the road suddenly dips, and when you cut away the bumps at the top of the places where the road rises.

But when you fill in the dips, you must not let water collect in a pond behind the fill. If the water seems to collect in a pond, you must cut a drain to let the water run away.

You must use good stone or sand or gravel for the fill. Also, you must ram it down hard. You can read how to ram material on page 66.

2. Horizontal Alignment. Make your road with easy curves or bends.

A good horizontal line means a road that has not got too many sharp bends or curves.

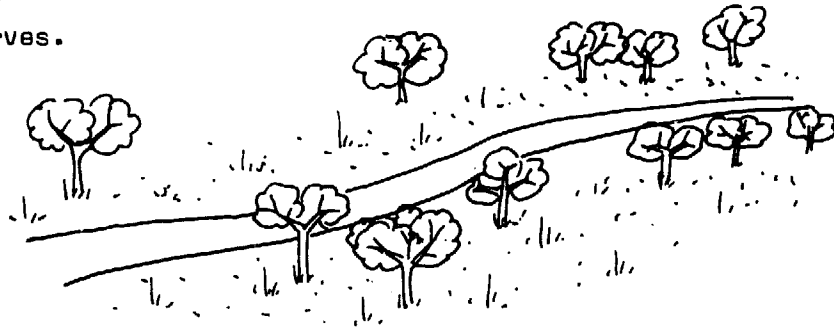

In hills or mountains, you cannot do much about getting a good horizontal line because that would take too much earthwork.

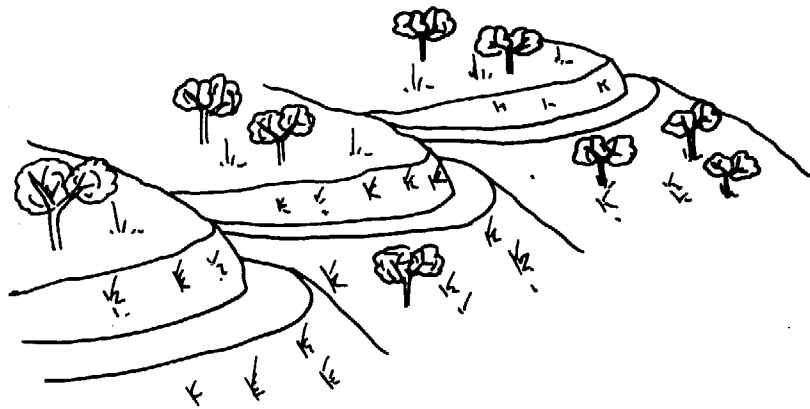

But in flat or easy country, you should try to build the road with a good horizontal line so that cars and trucks can go faster and safer.

Ask your Local Government Supervisor to help you get good easy curves.

The radius of curves should not be less than this.

Desirable standard	-	100m
Minimum standard	-	25m
Hairpin bends	-	15m

3. Temporary Culverts and Bridges

You can read some more about culverts and bridges on pages 90 to 128.

"Temporary" means something that will not last a long time.

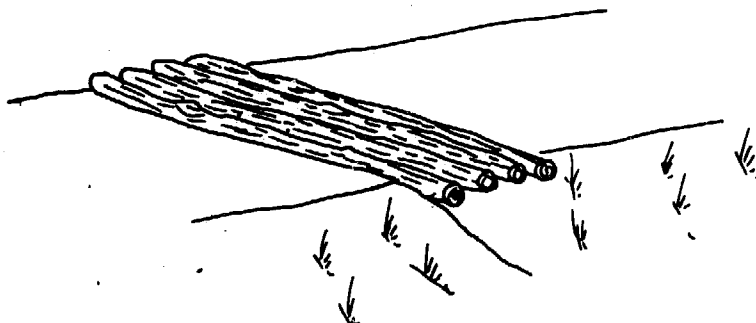

This is temporary bridge over a water course or a relief drain.

You can build a temporary bridge like this by putting logs over the drain. The logs should be about 100mm across the end.

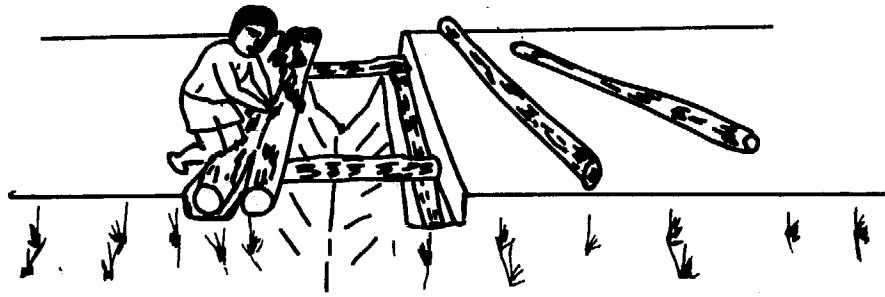

Usually you must cut a sill beam on each side of the drain to hold the short logs so that they do not go down into the banks of the drain or creek.

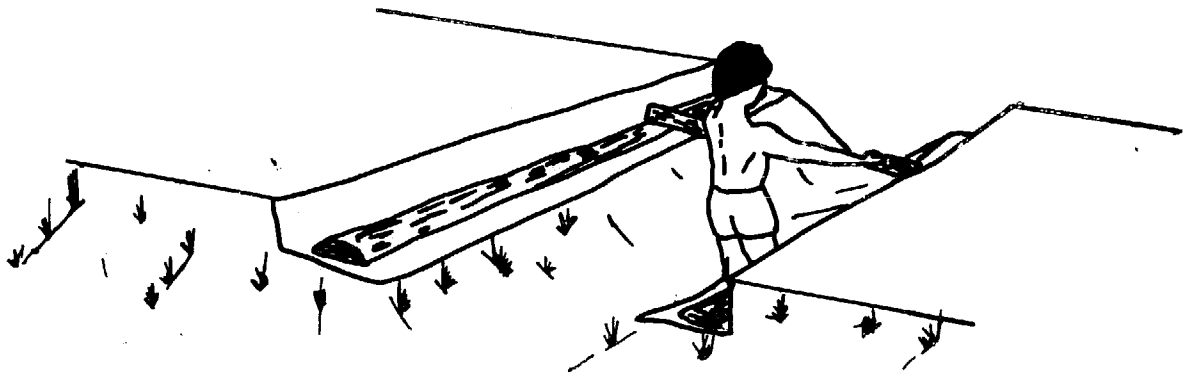

Suppose you want to build a good log bridge, read pages 104 to 119 in Section 8 about "Culverts and Bridges". Suppose you want to build a permanent culvert that will last a very long time. Read page 77 in Section 6 about "Upgrading".

4. Side Drains (these are also called table drains).

You must look at these regularly, to see if there is any erosion.

(Erosion means that earth is washed away by water).

Suppose you see some erosion.

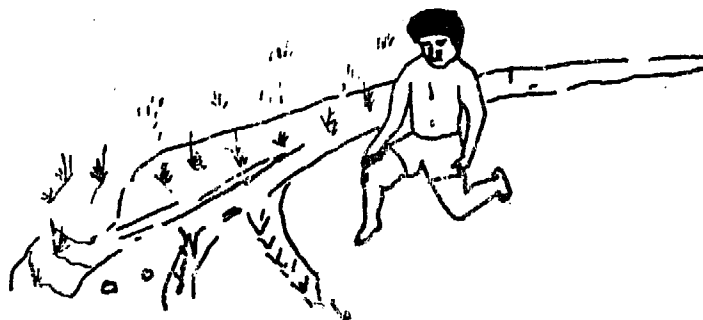

You must stone pitch the drain.



This means to put a lining of stones on the bottom and sides, to stop more dirt from washing away.

Stone pitching is very good to use where there is a lot of clay, because clay erodes easily.

Here is another way to stop erosion as much as possible.

You can "Step" the side drains like this.

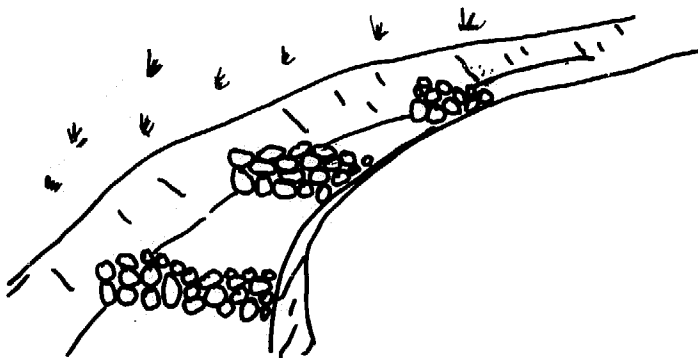

This picture shows a table drain with stone steps to slow the water down and stop erosion.

You make the small dams out of rock. You measure and build each dam 300mm high. The distance between them will depend on how steep the grade of the road is. The distance between each dam might be from 10 to 30 metres. You let the drain fill up with rubbish behind each small dam. This makes the drain not so steep and the water does not flow so quickly. You must dig a small pit under each step. Each pit must be 300mm deep. You fill the pit with stones. The water falls on the stones and does not cause erosion.

## 5. Filling

- (a) Do not build a road on top of fill, if you can build it in a different place.

Usually, Public Works Department Engineers do not like Rural Improvement Roads to be built on top of fill. Why not? They do not like Rural Roads built on top of fill because it is very hard to compact the fill properly. You need expert supervisors. You also need special equipment to ram down the fill properly. This equipment needs a lot of money. Also when you fill on a cross-fall slope, the fill may not be stable.

FILL PLACED ON  
CROSSFALL SLOPE.

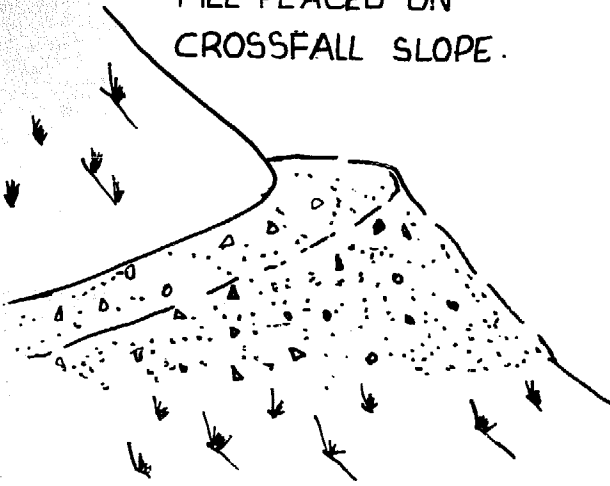

FILL HAS FALLEN DOWN  
BECAUSE OF POOR COMPACTION.

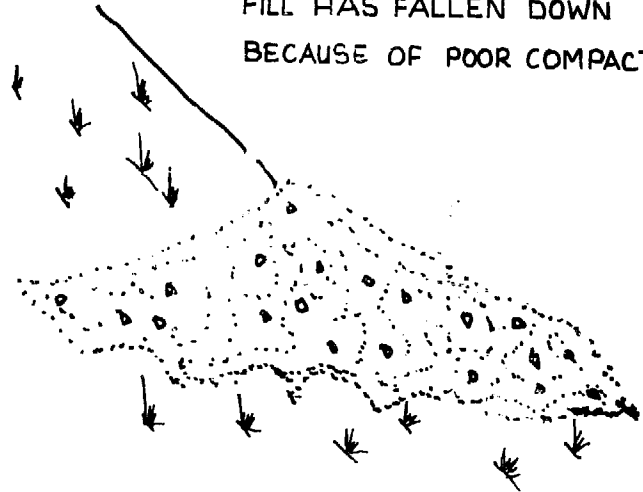

(b) How to fill:

BUT you will need a little bit of fill on your road and now I will tell you the best way to do it.

(i) See where the bottom of the fill comes to.

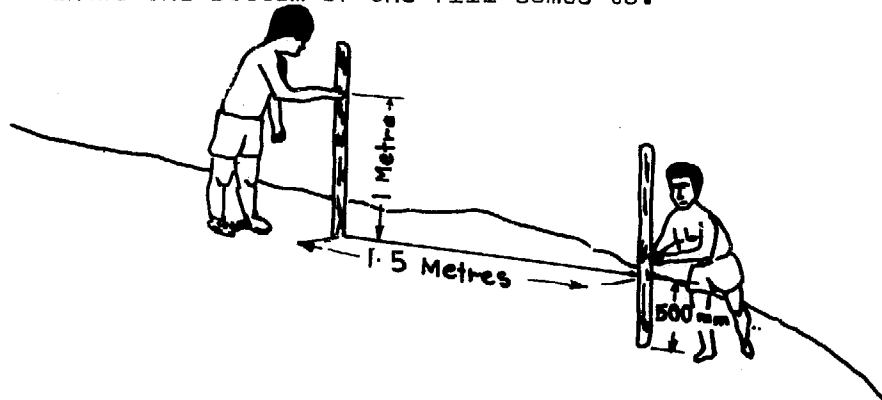

You start at the top outside corner where the fill will come. Work in steps, first down to the ground, then out horizontally,  $1\frac{1}{2}$  times that distance, then down to the ground again.

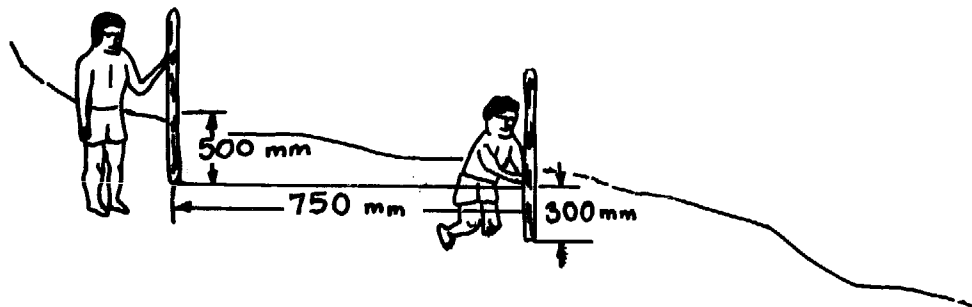

When the last horizontal measurement is on or near the ground (within 100mm), that is where the toe of the batter will be.

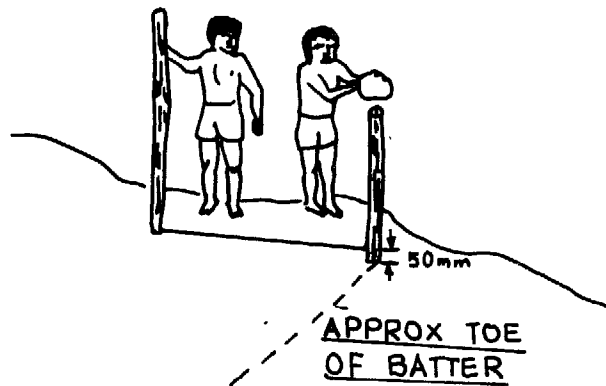

You cannot fill unless the natural slope is less than  $1\frac{1}{2}$  to 1.

(ii) Suppose you are filling on a cross-fall.

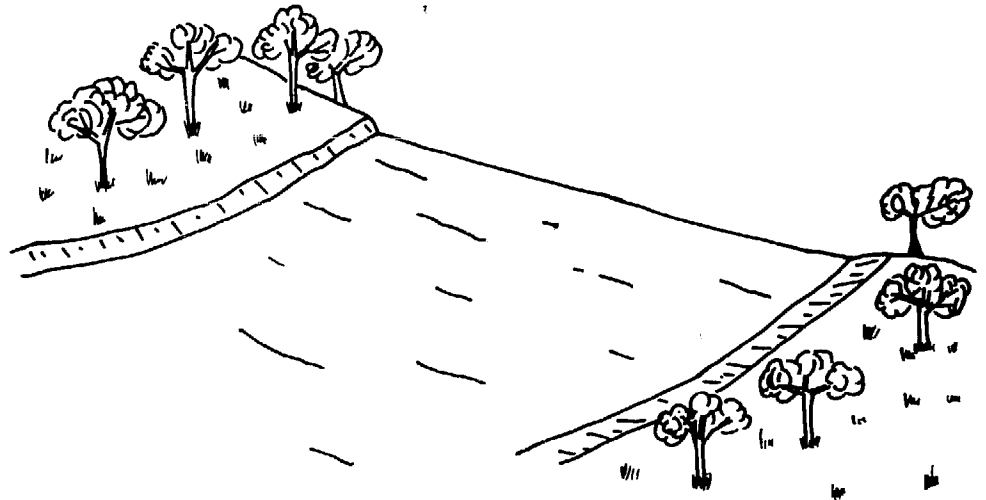

You clear away all the bush and trees and grass and topsoil from the place to be filled.

(iii) Suppose you are filling with no cross-fall or on flat ground.

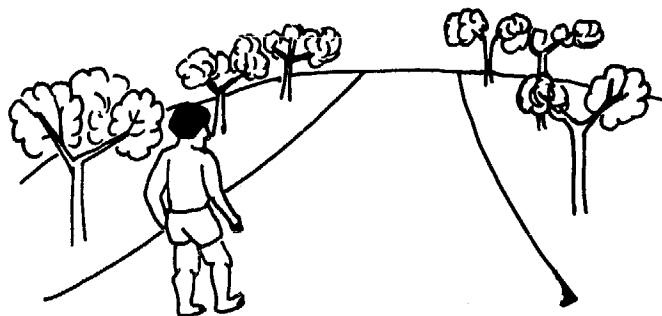



4. Camber on an Embankment road to keep the embankment dry:

You must keep the embankment as dry as possible. To keep it dry, you must form a camber for the road on an embankment. You form this camber from the beginning when you begin to construct the road. Most roads get a camber as the last thing, when the construction is finished. But a road in a swamp does not get camber last, it must have camber from the first mat of logs under the basecourse. You must supervise the road to see that the camber is kept all the time. When the road is finished you can set out a camber of the surfacing material of 1 in 24 if you can use a template. If you cannot use a template, read page 51 .

5. Road stabilizing fabric:

A new way of building roads in a swamp is to use "road stabilizing fabric". This is a thin sheet of strong material like plastic. You buy it in rolls. Each roll is usually about 5 metres wide and 100 metres long. You have to clear the trees and bushes (not the grass). Then you unroll the fabric where the road is to be built. Then, you cover it with 300mm or more of pavement such as sand, to form the road. You need machines (trucks or tractors and trailers) to do this properly.

6. What do you do when you have trouble building a road across a swamp?

There are a lot of different troubles about building a road across a swamp. This information is to help you with most troubles but you may find other troubles. If you have a trouble that this manual does not talk about, ask the Local Government Supervisor or Local Government Engineer for help straight away.

D OTHER INFORMATION ABOUT HOW TO MAKE A NEW ROAD

1. Vertical Alignment - Make your road go smoothly up hills.

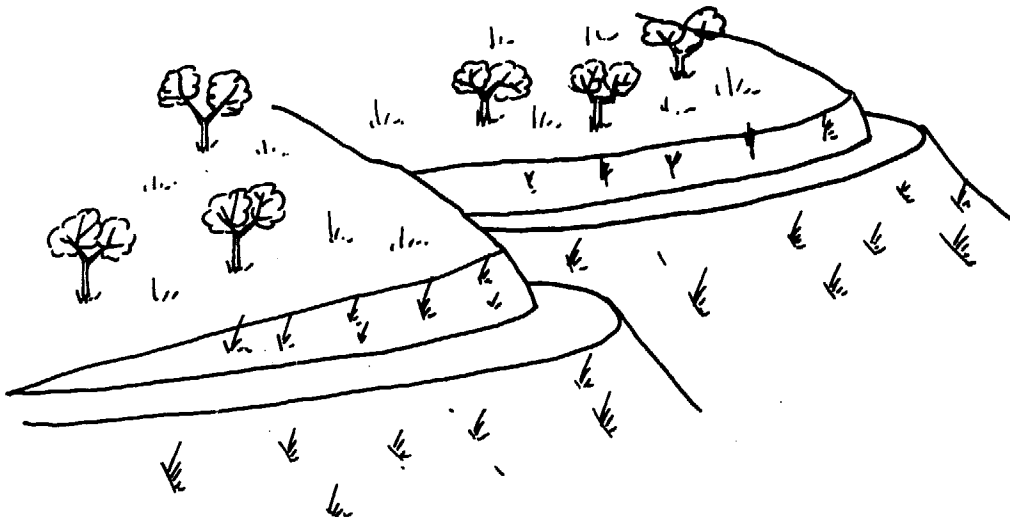

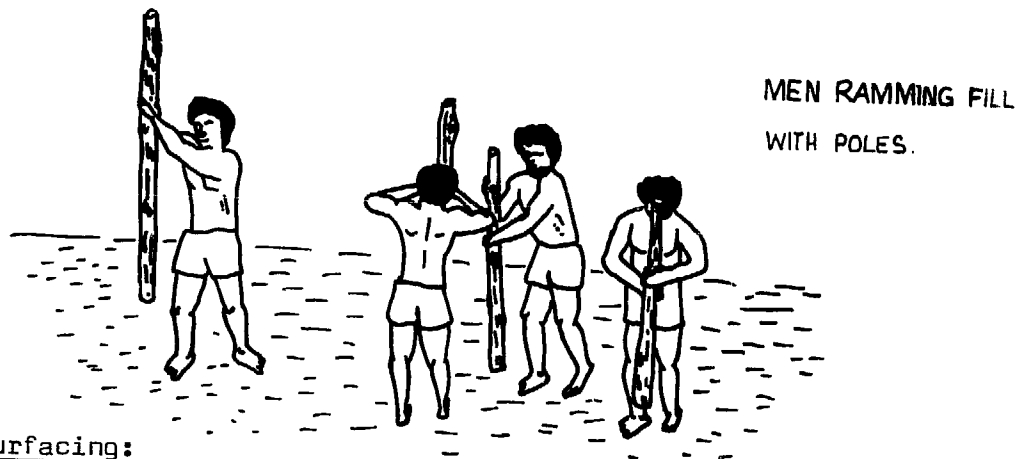

6. Surfacing:

- (a) When you build a road, the first aim is to make a road base that will not break up, when normal traffic uses it. The road base may be fill that you have carried to put on the natural ground. The road base may be the natural subgrade. BUT the road base must not go into holes when trucks run over it. The second aim is to have a surface that the wheels of cars and trucks can grip or hold and drive on, without slipping.
- (b) How much surfacing material do you need?
- (i) Suppose the subgrade is good. Then you need surfacing material that is 150mm deep before it is compacted. After ramming, the surfacing material should be 100mm deep.
- (ii) Suppose the subgrade is not good. You need a lot more surfacing material. Suppose you put down one layer of surfacing material that is 150mm deep before it is compacted. That is not enough. It will quickly be forced into the subgrade by the trucks. Then it is no use as surfacing material. You need to put down a lot of layers.
- (iii) Suppose you do not know if the subgrade is good or bad. You cannot always tell if the subgrade is good quality or not good. You must test little sections of the road before you surface all the road. You must put surfacing material on little sections of the road and make a tractor and trailer with a full load go over and over the section. You will quickly see if the surfacing material is strong enough.

The sections of road should be in different parts of the road. One section should be on a steep part, another section not so steep. One section in the shade, another not in the shade. One section on benchcut road, another section on flat ground, and so on.

You must test in dry weather and wet weather.

- (iv) Suppose you put on surfacing material but the subgrade will not stand up to normal traffic.

Then you must ask the Local Government Supervisor for help. He will tell you what to do to surface the road. You might have to carry material like stone or sand to the place to make a fill. This is what you do when you build across a swamp. Read about this on page 55.

- (v) Suppose your work is to make an old road better.

You call this "upgrading" a road. You can look at the old road and look at the surface. If the surface is in good condition, you know the subgrade material is good. If the surface is in bad condition you know the subgrade material is not good or the surfacing material is not thick enough. BUT think about one thing. The old road may be more steep than the new road. If it is more steep, the trucks work harder on it and the surface will not be in such good condition. The trucks will not work so hard on the new road that you build because it will not be so steep. The subgrade will be too weak for a steep road, might be strong enough for a new road that is not so steep.

- (vi) Now here is one important thing: Suppose the road is very steep. (More than 10% grade).



You must put surfacing material on any road that is steep like this. You must surface the road straight away, as soon as they finish the first construction.

You must not let any trucks on the road before the road has been surfaced. Suppose you let trucks drive on a steep road before you have put surfacing material on the road. The trucks will cut up the subgrade and the trucks will make hard work for you to do.

(vii) How much surfacing material on a steep road?

The surfacing material must be deep enough to prevent trucks from cutting up the road surface. Suppose you told the people not to use the road but some trucks and tractors used the road and road is cut up. What do you do before you surface the road? You must take away all loose material. Then you must camber the road again. Then you can put down the surfacing material. The surfacing material must not go on a subgrade that is soft and muddy, because you will need a lot more surfacing material.

(viii) What do you use for surfacing material?

- a. The best thing is coronous if you have coronous pits in your area.
- b. Hard stone with sharp points is good.

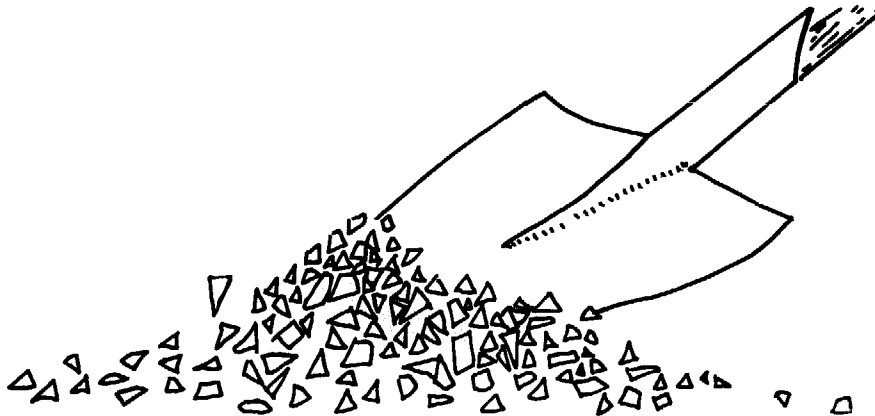

- c. Round smooth river gravel is not good because it rolls out of place when trucks go over it.

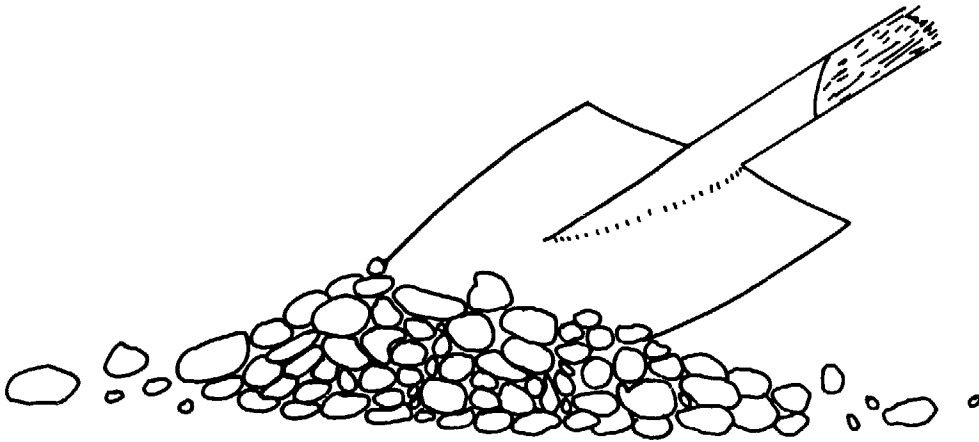

If you have no machinery, stone may have to be dug and broken up by hand tools - picks, spades and sledge hammers. It is good to use a little sand and clay with the other material. One part of sand and clay in ten parts of other material would be good. (That is, 10% sand and clay). This helps you compact the surfacing material better, and holds it together.

7. Removing Solid Rock.

It costs a lot of money to buy dynamite, to blast rocks. Also, in remote areas, it is hard to find the proper equipment. Usually, you can break the rock with fire and water. You must build a fire on the rock and keep it burning very strongly for at least four (4) hours. You must use wood that burns very hot. On the coast, a fire of coconut shells is very good. When the rock is very, very hot you must throw a lot of water on the rock. Buckets and buckets of water. This cold water on the hot rock will make the rock break into pieces. BUT look out that all the people and children stand back from the rock. The rock may explode and hurt them.

8. Razor-back ridges.

In some areas, the road must go along a narrow razor-back ridge. These ridges may be only 2 metres wide at the top. But your road should be at least 5 metres wide, or better 8 metres wide. What do you do? You must cut down the top of the ridge. But first, you must plant a "wall" of planted trees and bamboo on both sides of the ridge.

- (a) The ridge should be cut down to where it is at least 8 metres wide.

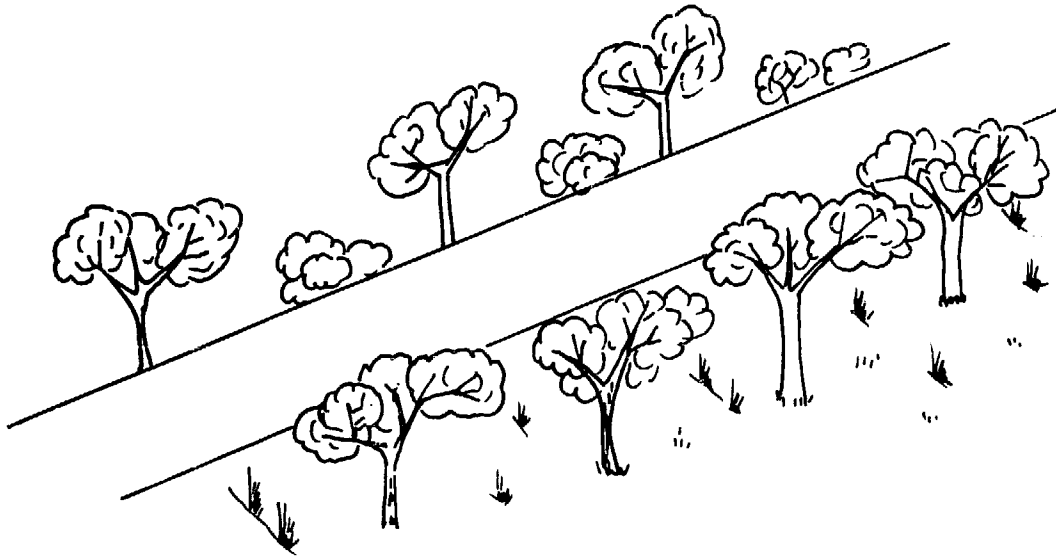

Suppose the 2 sides of the mountain are too steep (more than 1 to 1 slope). You may not be able to cut the ridge down to 8 metres wide, but the solid width must be at least 5 metres wide.

- (b) Now you must plant the "wall" of trees and bamboo 4.5 metres on each side from the centre of the ridge. As these grow, the roots of the bush will be like a safety fence for the trucks and tractors. Later you will cut down the ridge. You can pile up clay against the "wall" of bush. This wall will make the formation wider and will give more safety for trucks in trouble. But this extra width will not usually be used, so you must mark the sides of the solid ridge-top with strong posts that can be seen easily.

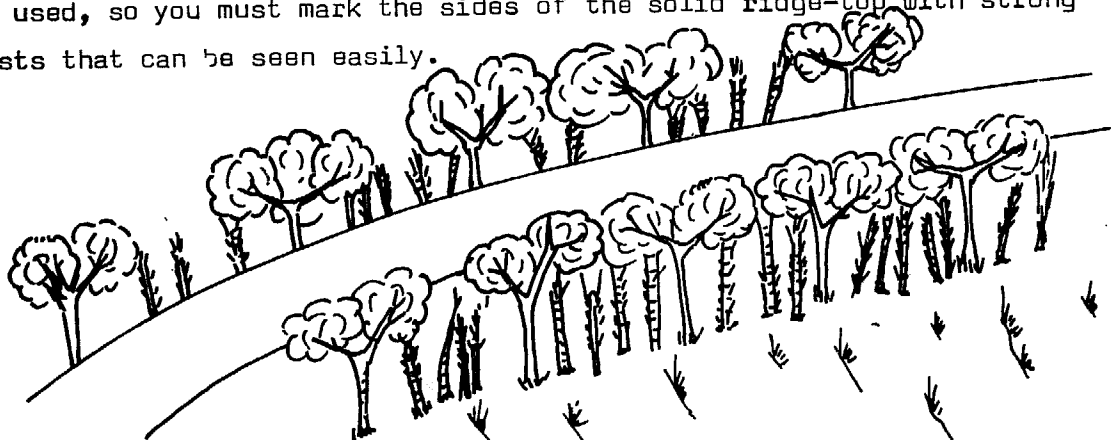

Suppose you think maybe a road like this is not possible. Suppose you think it is not safe. Suppose you are not happy about it. Then you must write to the Local Government Engineer, Soroko for advice and help.

(c) Draining a razor-back ridge

When you drain a razor-back ridge road like this, you must take care that you do not lose any of the road by erosion. The narrow section of road will usually be in a place in the mountains like this:

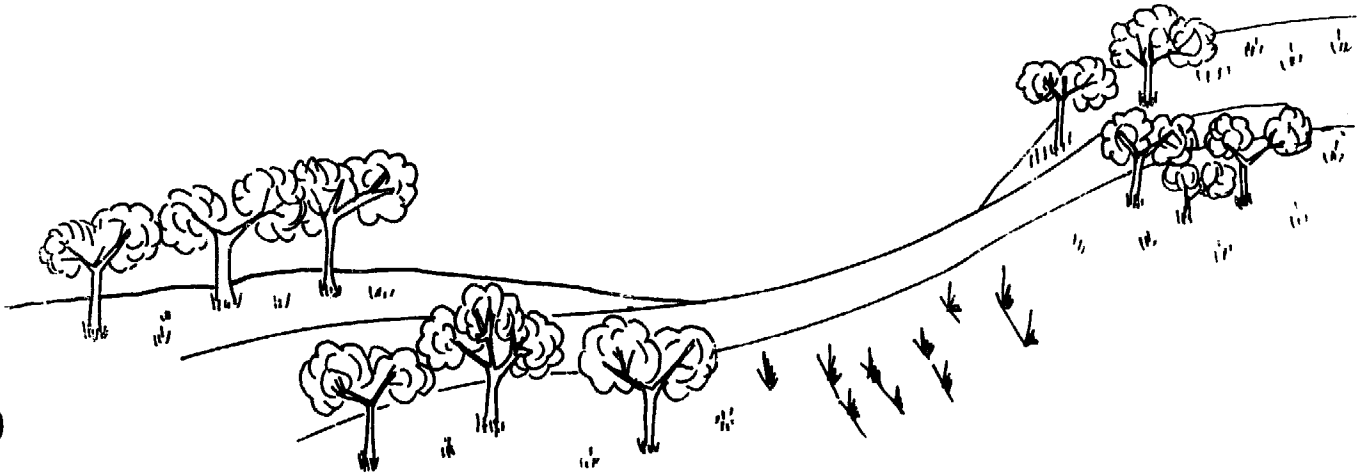

You must make two channels for the water at the two ends of the narrow section so that the water will go over the side of the ridge before the water reaches the narrow section.

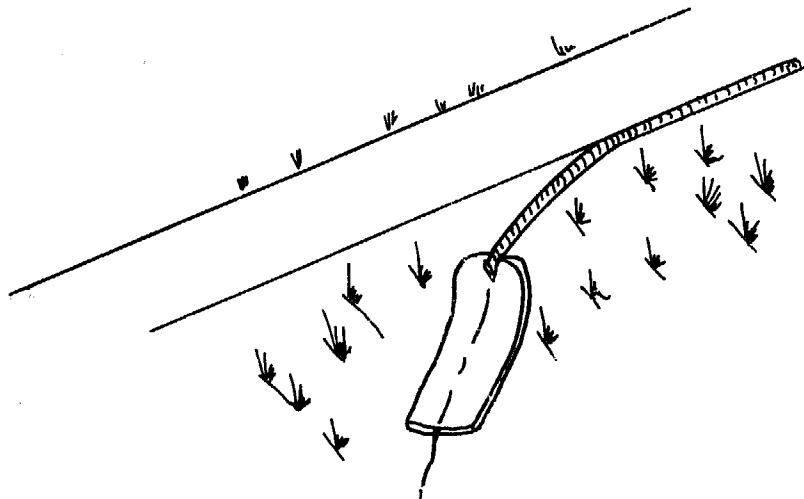

You will probably need to build "aprons" made out of concrete at the places where these relief drains let out the water. These aprons will let the flash-flowing water spread out without causing erosion. You can read page 102 to 104 in Section 8 about "Culverts and Bridges" to learn how to build a concrete apron.

You must always look out for erosion on the narrow ridge top. You must stop erosion straight away if it starts. Some months may pass before drainage and erosion troubles begin to show.

9. When can trucks use the road?

When you begin to construct or upgrade a road, you must decide whether trucks can use the road straight away when the road is finished. If the road is not surfaced, it should not be used until the new earthwork has settled down.

Suppose you decide that trucks should not use the road straight away when the road is finished. Then you must not let even one truck on the road. You must dig a trench across the road or leave a river without a bridge so that no trucks can use the road before you want trucks to use the road. Even one truck can damage a road badly. Suppose one truck uses the road and damages the road. Read page 69 to find out what to do.

10. Construction Management. (What to do with the workmen).

This book is not the right place to advise you how to manage your men. But I will tell you one thing about managing your workmen. Suppose you have a lot of workmen. You should divide them into groups. Each group of men has special work.

The men in Group 1 clear the bush.

The men in Group 2 make the first earthworks.

The men in Group 3 form the road - camber and drainage.

The men in Group 4 construct bridges.

The men in Group 5 surface the road when the initial construction is finished.

The five groups can all work at the same time on different sections of the road. As the group gets good at the special work of the group, you will not need to supervise so much. Do not let the men change around from one group to a different group.

How can workmen make the road the proper width if you are not there to supervise? You can give the labour line a piece of rope with knots or markers that measure distance. Give them one rope that measures the distance from centre line to the outside of the road formation. Give them another rope that measures the distance between the drains.



If a road was not well-built with camber and drainage, it will lose pavement faster. If it was well-built, it will lose pavement more slowly.

Suppose a road is drained, but stays soft and muddy. Then you know that the subgrade is not good enough, or there is not enough basecourse, and you should ask the Local Government Supervisor to help you. The surface material gets worn off all roads. When it is worn off, you must put down a new layer before all the old layer is worn away. This is called resurfacing or "resheeting".

Suppose you do not fix the road and all the pavement wears off. Then the trucks will cut up the road, and the damage gets very bad.

#### When do you re-surface a road?

On a good hard road with good pavement, you might need to re-surface it after three years. On a bad road with bad pavements, you might have to re-surface it after six months. If the road is steep, it will lose its pavement more quickly.

#### How do you re-surface a road?

New pavement can be carted and spread by hand, but that is a slow job. If your Council can use tractors and trailers, you can do the job quicker. If your Council can use trucks and a grader, you can do the job quickest and get the best result with these. Graders are best but they cost a lot of money.

#### Can your Council buy big Equipment?

The Council has to think if it has enough money to do the job by machines. On the more important roads called "feeder roads", the Council gets some money from the Government for maintenance.

### 3. You must make the camber good again.

A road can get flat and not have a camber. Then the road will have potholes, bumps and bad drainage.

What you do if a short bit of road has lost its camber?

In some places, if the trouble is not too bad, you can just "top up" the road along the middle, and get back the camber.

If a few metres of the road have got soft and have sunk, then you can dig out the soft material, 0.7 metre deep, and fill it up again with good hard stone. You put the new stone in layers 0.15 metres deep, and ram it down.

"Upgrading" a road means improving a road. You make it a good road.

A. WHY DO YOU NEED TO UPGRADE A ROAD?

In Section 1, we said that roads that are too steep are bad, for five (5) reasons:

1. Ordinary trucks and tractors cannot use roads that are too steep. Only 4-wheel-drive trucks can use them.
2. These roads are not safe. A truck going down a steep hill might slide and crash.
3. Trucks have to work hard when they go up a steep road. This damages the road.
4. Rain water runs very fast down a steep road. This damages the road.
5. It is hard to improve a steep old road - you have to build a new one. This is called "upgrading".

You can read about this on pages 76 to 80 .

B. HOW DO YOU UPGRADE A ROAD THAT WAS NOT SURVEYED BEFORE IT WAS BUILT?

1. You must get the road surveyed. Many old roads will be good new roads if you only change the steep sections. Suppose the survey shows that there are two places that are very steep. All right, you can construct 2 new sections of road that are not so steep in those two places. That is enough. Now your road is upgraded enough.
2. Put in temporary log bridges and culverts - a temporary bridge is one that trucks can use for a little time until you build a permanent bridge in that place.
3. Put down some surfacing material. Not very much, just enough so that trucks can use the road but not cut up the surface. Now you must ask the Local Government Engineer in Boroko to send a surveyor to survey the places where you will need bridges and culverts.
4. Next you will construct the new permanent bridge and culverts. At the same time, you will make the horizontal line better. You can straighten some places and make some bends less sharp. Build new culverts and bridges when you do this work.
5. The last thing to do is to construct a good pavement. Read page 67 to find out how to do this.

C. HOW TO CONSTRUCT A ROAD IN VERY STEEP COUNTRY

Suppose the country is very very steep. Then you cannot construct or widen the road like I have just told you on page 75 . That does not matter for most of the road. BUT at the crest of a hill you must construct the road very carefully. You must construct the road so that the pavement is 3.6 metres wide and so that the formation is 8 metres wide. You must construct the road as wide as that for 70 metres, on both sides of the crest of the hill. This makes the road more safe. Trucks will not crash so easily.

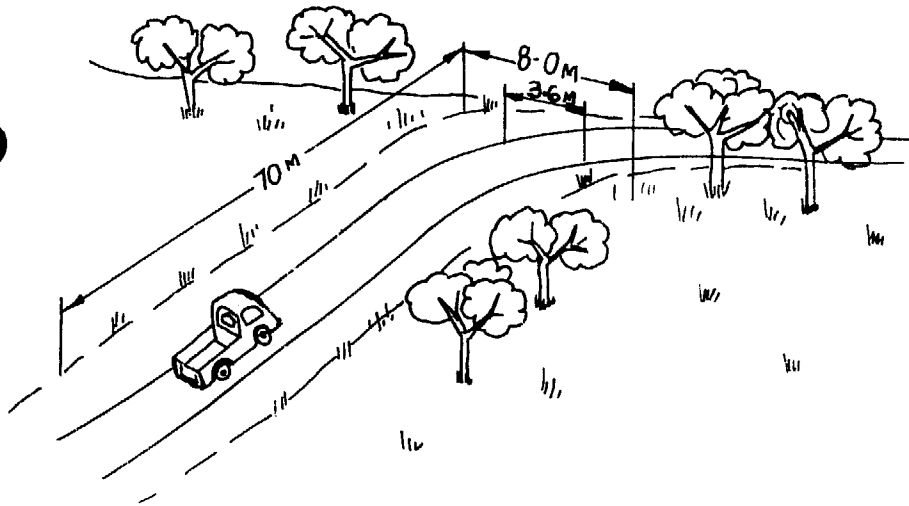

This picture shows the road getting wider near the top of the crest.

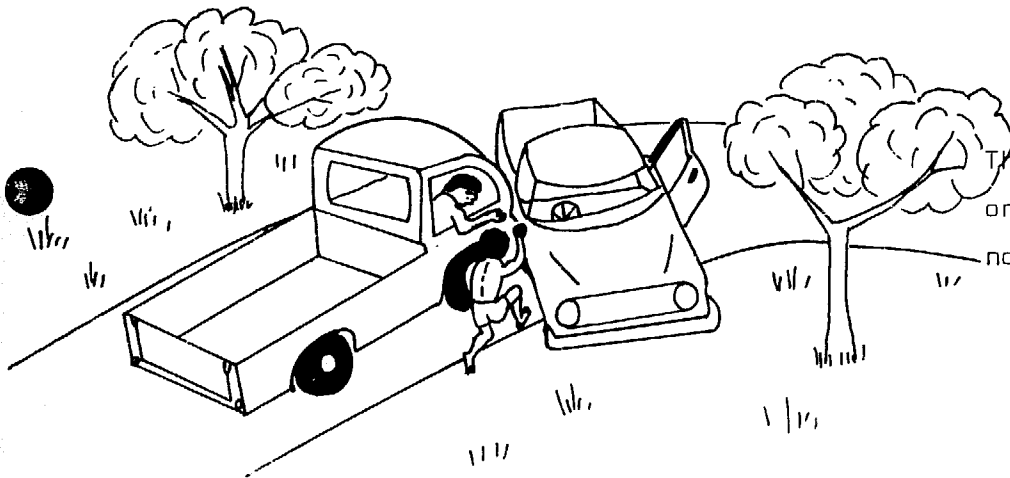

This picture shows an accident on a crest because the road was not built wide enough.

D. NEW CULVERTS

When you improve the horizontal alignment of most roads, you should also make new culverts. You do not need to do this in country with a very little slope.

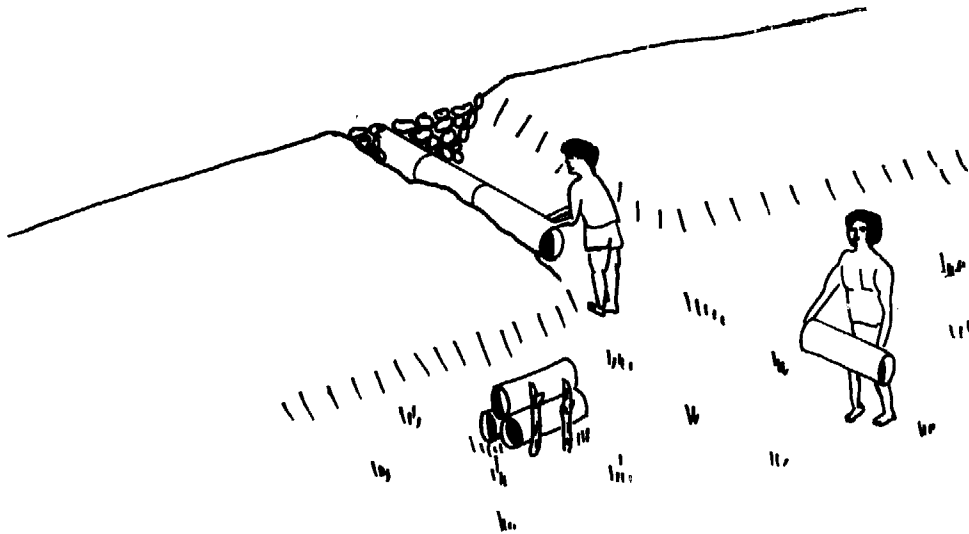

Why do you have to make new culverts for most roads when you upgrade them? Because when you cut back corners and widen the road you dig a lot of ground. It is good to use this ground to fill gullies. You fill the gullies and compact the material like I told you on page 66 .

When you fill gullies in this fashion, the length of the culvert under the fill must be longer than the road is wide. The extra length is 3 times the depth of fill. You must think about this fact when you buy the culverting. For example, if the fill is 3 metres deep, the culvert will be 9 metres longer than the formation width of the road.

If you construct "extended headwalls", the culvert need not be so long. Read page 100 , to find out about "extended headwalls" in the Section about "Bridge and Culvert Construction".

E. MAKE THE CURVES AND BENDS MORE EASY

When you upgrade a road, you must try to make the curves easier than they were before.

They will have a larger radius. That means, they make part of a bigger circle. The trucks will not have to turn around curves so quickly, and there will be less danger of accidents.

See the picture on the next page to show what I mean.

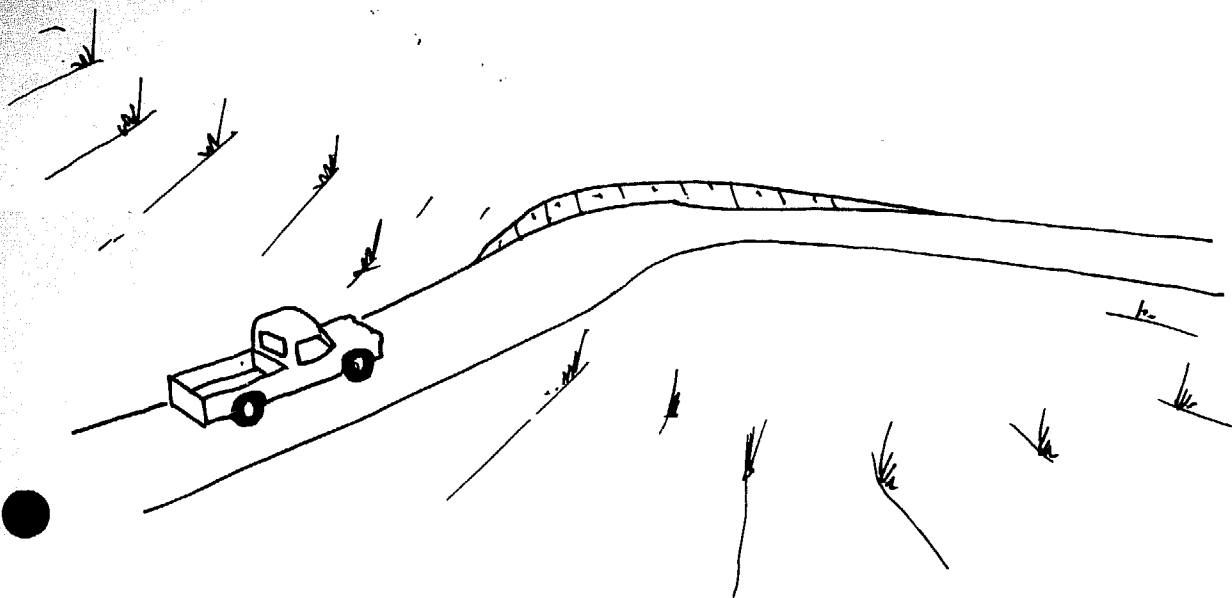

When you construct the curves like this, the road will be shorter. Some of the road will be more steep, and this could be a bad result. But there are good results also. Here are the good results:

1. You will put on surfacing material.
2. The road will be wider.
3. It will take less time to go from one place to another place.

There are three good results and one bad result, so you must be careful.

Suppose the road is too steep. Then you cannot use the road and that is no good. When you change the road, use boning rods. I told you about boning rods on page 29. Boning rods help you to make an even grade between pegs. The road will go up smoothly. You use the boning rods between one section of the old road that you do not want to change and the next section of the old road that you do not want to change.

#### F. WHAT TO DO IN PLACES WHERE THE ROAD GOES ROUND A CORNER

In places where the road goes round a corner, you must do two things. First, you must raise up the outside of the road. This is also called "super-elevation" the road. I will tell you about this later on next page. Second, you must make the pavement of the road more wide.

Why do you raise up the road at corners? When you raise up the road at corners, it makes the road "guide" trucks round the corner.

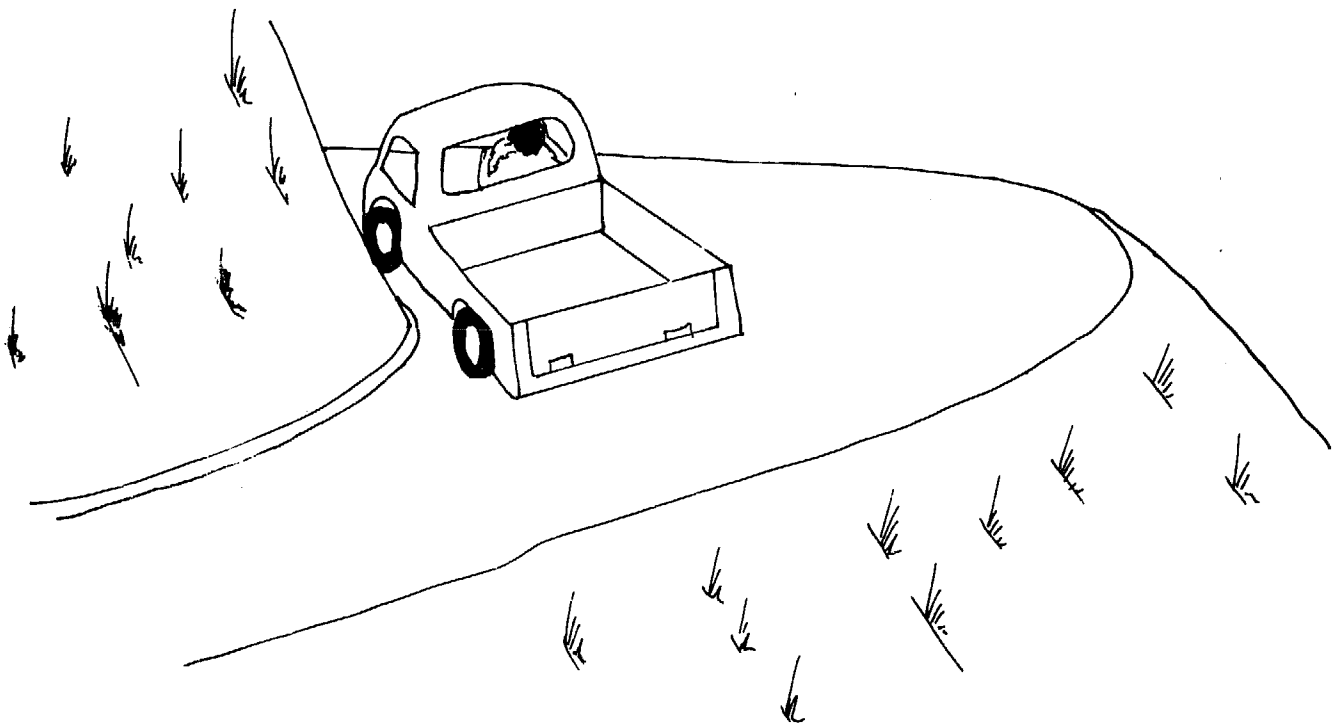

If you do not raise the road at corners, the trucks might slide off the road when they are going fast round the bend.

How do you raise up the road at corners?

You start to raise the outside corner while still on the straight part of the road. On an ordinary road, the surface has a camber both ways of 1 in 24. Still on the straight, you raise the side that will be the outside of the curve, by tilting it round the centre line of the road, until the whole road slopes to the inside of the curve.

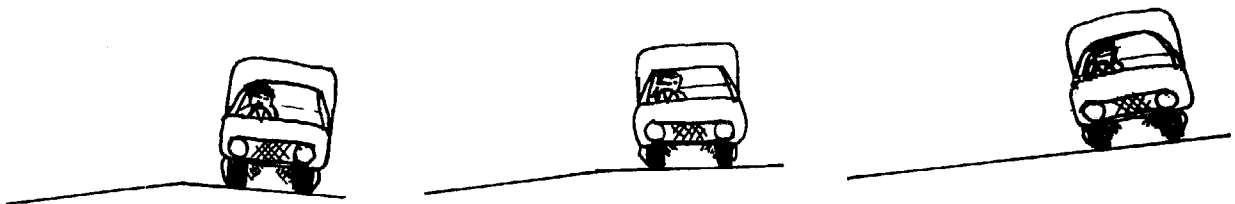

ON STRAIGHT ROAD

NEAR TO THE CORNER

ON CORNER

Then you raise the whole surface more tilting round the inside edge, until it reaches the right slope, or super-elevation, just where the curve starts.

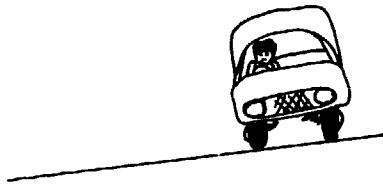

GOING AROUND  
THE CORNER



COMING BACK  
TO THE STRAIGHT

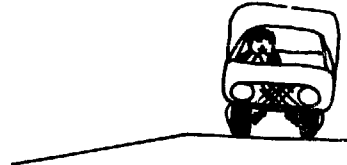

BACK ON THE  
STRAIGHT ROAD

This goes right round the curve, then after the curve is ended, the surface gradually goes back to the normal camber again. You should use a spirit level and wooden frame (template) to set out this work.

G. YOU MUST MAKE NEW DRAINS WHEN YOU UPGRADE A ROAD

You know that good drainage is very, very important. You must have good drainage or your road will not be good. You can look at the old road and see if the drainage for the old road was good. Read pages 52 to 54, about drainage in Section 5, called "Beginning to Make the Road". You must do the things I told you about in that section to have good drainage. You must set out the camber of the road properly on the straight section of the road when you upgrade a road. You should use a template to set out a camber of 1 in 24.

WHY DO YOU NEED TO MAINTAIN A ROAD?

You might have a road that is well built, but you have to keep looking after it, to keep it in good order. This work is called "maintenance". The best way to maintain a road is to keep looking after the road all the time. Then you will see trouble spots when they are small. You can fix them up before they turn into big troubles. Big troubles cost a lot of money and work to fix. The road might break up altogether. You cannot use a road that is not maintained for a long time.

Now I will tell you how to maintain a road. I will tell you how to maintain bridges in the next section.

WHAT DO YOU DO TO FIX UP OR MAINTAIN A ROAD?

There are three bad things that happen to roads:

1. Roads get potholes.
2. Roads loose the surfacing material.
3. Roads loose camber.

1. You must fix up potholes.

When holes come in the road, they fill up with water, they get soft and make bad bumps. How do you fix them? You dig out all soft material. Then you fill the hole again with good gravel, and pack it down hard. It is a good idea to leave heaps of gravel spread along the road, so the road men can soon fix the potholes.

This is a very good idea in places where the Council has a "road maintenance day" each week.

2. You must put back Surfacing Material

The road might be well built, but it will always loose the surfacing material. This happens because the trucks throw it off the road, or squeezes it down into the mud. Also, the pavement is worn away by sun, rain, wind, animals or people walking on it.



11. Summary:- A List of Important Things.

Here are some important things you must know about the first part of building a road:

1. Pegs show the level of the surface of the road when it is finished. That means the numbers on the pegs show how much to cut or fill from the ground level at the peg.
2. Pegs may not be on the centre-line of the road. They are put in the ground to show the level of the surface of the finished road. They are not put in to show the centre-line of the road.
3. Build an even grade between pegs. Then smooth out any curves at crests or hollows.
4. The surface must have a camber. Also there must be good drains to keep water off the road.
5. Fill has to be rammed down hard.
6. After the road is built, watch it carefully for a year to see if anything goes wrong.
7. Do not change a marked line of pegs, without asking the District Local Government Supervisor.
8. All roads which are steeper than 10% grade must have a hard surface before trucks and cars start to use the road.

If the soft spot is holding water, you may need a new drain, or pipe, or a drain filled with stones. If you cannot fix a very bad place, ask the Local Government Supervisor for help.

**What you do if a long part of the road has lost its camber?**

If a long part of the road loses its camber quickly, the trouble might be because of three reasons:

- (i) Maybe the fill is poor, or not compacted (rammed down).
- (ii) Maybe the road is not wide enough, and all the trucks go down the middle and make deep wheel tracks.
- (iii) Maybe the subgrade is not strong enough.

The first two troubles were made when the road was built. To fix them you have to rebuild the road properly, as this book tells you. The third trouble is fixed by putting on more good basecourse, and then another layer of pavement.

When a road has become flat, it can be fixed by teams of road workers going along with spades to throw the stones from the edges, back into the middle of the road. If the Council has a grader, the grader does a better job than hand work, but is more expensive. In some places, graders cannot get there at all, and the work has to be done by hand labour.

## C OTHER MAINTENANCE JOBS

The road workers have other jobs to do all the time.

- (a) After heavy rain, look at the culverts and drains. If any are blocked by dirt, stones, sticks or so on, they must be cleared straight away.
- (b) The edges of the road must be kept clear of long grass, bushes and young trees. It is a good idea to leave the grass growing to stop erosion, but it should be kept cut short.
- (c) The side drains should be kept clear of growing plants and rubbish. Then water can flow along them and get away.
- (d) At any places where the road is starting to slip away, you must put in new fill and see that there is proper drainage.

The rule for all roads is to always look at them, and to always work where it is needed, straightaway. Sometimes, a big job of resheeting must be done, but other jobs can be kept down if you fix the road straightaway when it needs fixing.

D

## ROAD GANGS ON SECTIONS

When a long road is being maintained by hand, it is a good idea to have men working on it permanently.

If you have tractors and trailers or small trucks, one overseer ("roadmaster") with one tractor and a gang of eight or ten men, can look after about thirty kilometers of road. They should have a camp near the middle of this section of road.

If you have no machinery, it is a good idea to have a "roadman" to look after one smaller piece of road near the place where he lives. This piece might be three to five kilometers long. Then he can walk along his section of road every day with a wheelbarrow and spade and fix up trouble-spots.

E

## THE GOVERNMENT WILL HELP COUNCILS MAINTAIN THEIR ROADS

### Money for Feeder Roads

The Government will help Councils by paying some money to help them look after the more important roads in their area. These important roads are called Feeder Roads.

In October, 1974, a letter was written from the Public Works Department to tell all Councils about this.

This is what it said:

"The President,  
Local Government Council.

### FEEDER ROAD MAINTENANCE ALLOCATIONS

Dear Sir,

This letter is to tell you about money that may be paid by the Government to help Councils look after and maintain their roads.

### CLASSIFICATIONS:

The Government made a law called the Roads Maintenance Ordinance. It said that roads in Papua New Guinea were to be divided into different types, or classifications like this:-

- (i) Big roads are called "Highways" or "Trunk Roads". The Government will look after them.

- (ii) Middle roads are called "Feeder Roads". Councils can look after them, and the Government will give some money to help.
- (iii) Little roads are called "Minor Roads". The Government will not give any money at present, and the Council or the people have to look after them. (Next year, 1975/76, the Government might give some money on the Rural Improvement Programme to maintain these roads).

#### ROADS BOARDS

Each District has three men called the District Roads Board. They decide what roads will be Highways and Trunk Roads, what roads will be Feeders, and the rest that stay minor roads. These men have now done their work in most Districts, and Councils will soon be told what are the Feeder Roads in their places. You should soon get a letter about this from your Public Works Office in the District.

#### FEEDER ROADS - COUNCIL MAINTENANCE

Now, Councils will have to decide if they are going to look after their Feeder Roads. If they agree to, the Government will pay a grant of funds to help. If a Council does not agree to look after these roads, then the Government will not pay this money. If a Council says it will not maintain a feeder road, then the District Roads Board will say what to do. Maybe the Government will look after the road, or maybe the road will be left alone and get broken up, and no one will be able to use it.

When a Council agrees to maintain its Feeder Roads, it has to pass a resolution to do this. Then it must sign an agreement with the Government.

#### AGREEMENT

A copy of the Agreement is enclosed with this letter, for you to look at. The main things it says are:-

1. The Government and the Council make an agreement.
2. There is a list of the Feeder Roads or towns with roads to be maintained.

3. The District Works Engineer or Officer will represent the Government. The Local Government Engineer will advise Councils when they ask.
4. The Council agrees to be responsible for maintaining these roads.
5. Money granted by the Government must be spent on these roads, and books and accounts kept to show this has been done.
6. The Council will employ an overseer (road-master) as soon as it can, to look after this work. His costs can be paid from this grant.
7. Extra money may be given if there is bad trouble with some roads.
8. The Council will take notice of any talk from the District Roads Board or the Government's engineers or other representatives.
9. The Government will hire plant to the Council when it is needed (this is done by the Plant and Transport Authority).
10. The Council has to pay any compensation for people hurt or killed on roads due to maintenance works or mistakes by Council. Insurance should be taken against this.
11. The Government will pay the grant regularly to the Council, without a claim. The grant is not fixed like a contract; it depends on how much money the Government has each year.
12. If there are any disputes, they should be talked over with the District Roads Board.
13. If the Council does not try to do a good job, the Government can stop paying money. But before doing this, the Government will try to help the Council get over any trouble.

#### SUPERVISION

The Government is worried because there are not enough skilled technical men in the country to properly look after the Rural Improvement Programme and the road maintenance.

We are trying hard to get more men for this work, and hope to be able to supply some men in every District to help look after Council works and maintenance. This does not mean we want to interfere with Councils that can look after their own work, but we want to help Councils that can not. At present, most Councils need this help. We are also trying to help train staff for Councils and where possible will help Councils to get their own staff. A small part of the money granted by the Government for Rural Improvement Funds, may be kept to pay Government staff who will help Councils.

#### DISCUSSION

Please talk about this letter when the Council has its next meeting so that your Council will be ready to decide about its feeder roads when the District Works Engineer or Officer writes to you. If you have more questions, you can ask him to come and talk to you, or to send one of his road men to do this. Remember he will be in charge of seeing the Council does its job with Government money.

If there are any worries which you cannot agree with, the District Engineer or his staff, you can ask for advice from the Local Government Engineer at Public Works Department Headquarters in Port Moresby.

#### TOWN ROADS

Councils can also take over the maintenance of roads in towns and Government stations, if they want to and if the District Engineer/Officer agrees. A separate grant would be paid for town roads, and must be spent in that town. If Councils do not want to do the town roads at present, that is all right, and the Government will still look after them.

#### CONCLUSION

There is a lot of work to be done looking after the country's roads. Councils have the chance to do their share of this work, and help the people in your area by seeing they have good roads. The Government is offering money to help Councils do this work, and the Government will give advice and help with supervision as much as it can.

It is now up to your Council to say if you are going to

do this work.

Yours faithfully,

for: E. ROBIN SAFITOA

Director".

This letter says that the Government will give money to the Councils to maintain Feeder Roads.

Some of the roads in your Council area are Feeder Roads. You can ask your Council Clerk which roads are Feeder Roads.

Your Council must have a Council Meeting. They must think "Will the Council look after the Feeder Roads?" Suppose they say at the meeting that they will look after these Feeder Roads, then they must write their names on a special letter called an Agreement. The Government men will also write their names on the Agreement. Here is what the Agreement says:

What does the Government say it will do?

1. The Government man is the District Works Engineer or District Works Officer.
2. The Government says the Local Government Engineer will help the Councils when they want help.
3. The Government gives the Council a list of the Feeder Roads or Town Roads that they must maintain.
4. The Government will give money to the Council to do this work. The money is called a "grant".
5. The Council does not have to ask for the grant with a "claim form".
6. The Government will give different amounts of money. If there is bad trouble with the road, the Government will give extra money. If the Government has not got much money, the grant will not be so big.
7. The Government will hire machines to the Council, when the Council needs big machines like graders. Plant and Transport Authority hires out these machines.

What does the Council say it will do?

1. The Council says it will maintain the roads that are written in the list of Feeder Roads and Town Roads.
2. The Council says it will use the Government money only on these roads. They will keep books and accounts to show how all the money is spent.

- (b) Concrete Pipes: Skid concrete pipes into the trench or roll them into the trench, then shove them together.

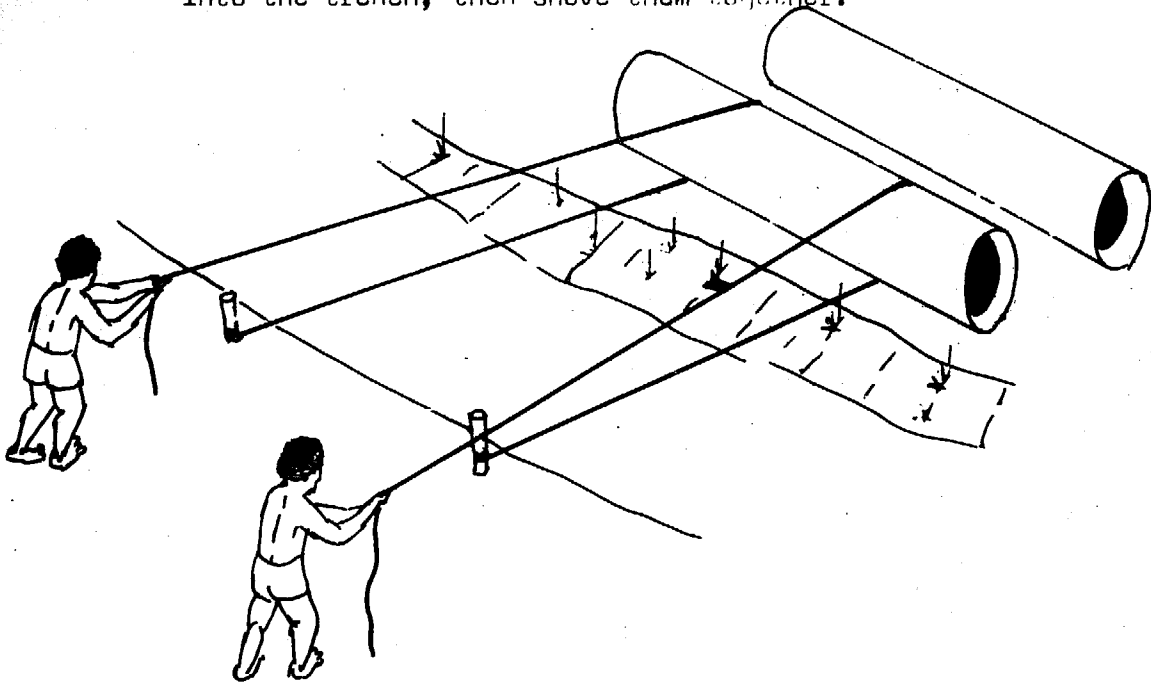

(c) How to lay two lines of pipe:

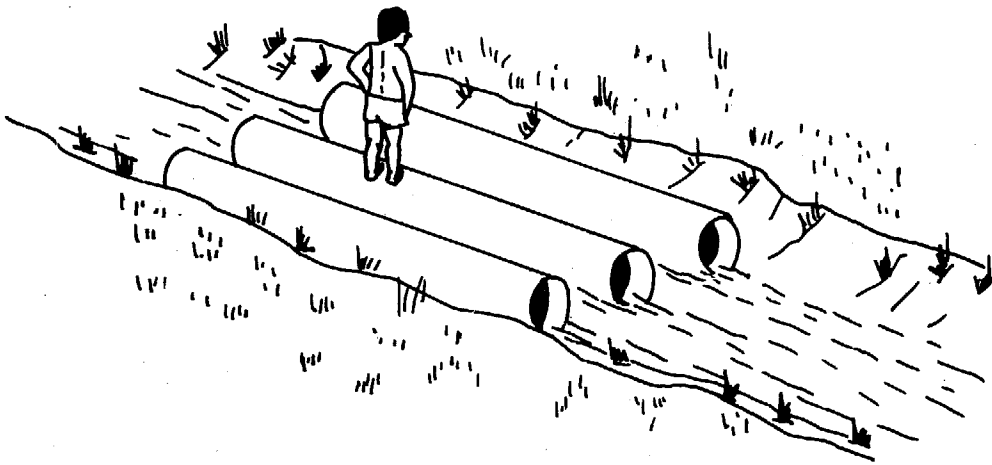

The lines must have a distance between them. The distance should be at least half of the diameter of the pipe, or 0.4m whichever is the bigger.

If each pipe diameter is 900mm., then the clear space between the pipes must be 450mm.

6. How do you backfill a trench round the pipe? You must supervise this very carefully. Suppose you do not do a good backfill, the culvert will be no good and it might get broken. Good ways to backfill are important to all culverts. Good ways of backfill are very, very important with a culvert under deep fill.



A. CULVERTS

1. What sort of pipe should you use? Usually, corrugated metal pipes are best. When you make a culvert for a Rural Improvement Road, you should usually use a corrugated metal pipe. But concrete ones are better in two cases:

(i) If you are close to a factory that makes concrete pipes in Papua New Guinea, you should use these concrete pipes. If the factory is less than fifty kilometres from your work, you should use a concrete pipes.

(ii) If the pipes will be in salt water near the sea, then metal pipes would rust. You should get concrete pipes for flat places where the sea comes in sometimes.

Concrete pipes are hard to lay properly. But corrugated metal pipes are a little bit hard to lay properly. I will tell you how to lay them properly. Also, you must read the directions from the people who make the pipes, and do what they say to do.

2. How big should a culvert be? The District Local Government Supervisor or the Local Government Engineer will tell you how big all the culverts should be if you ask them to come and look at the road. But you yourself, can work out how big a culvert should be. You want to find out the diameter that the culvert should have.

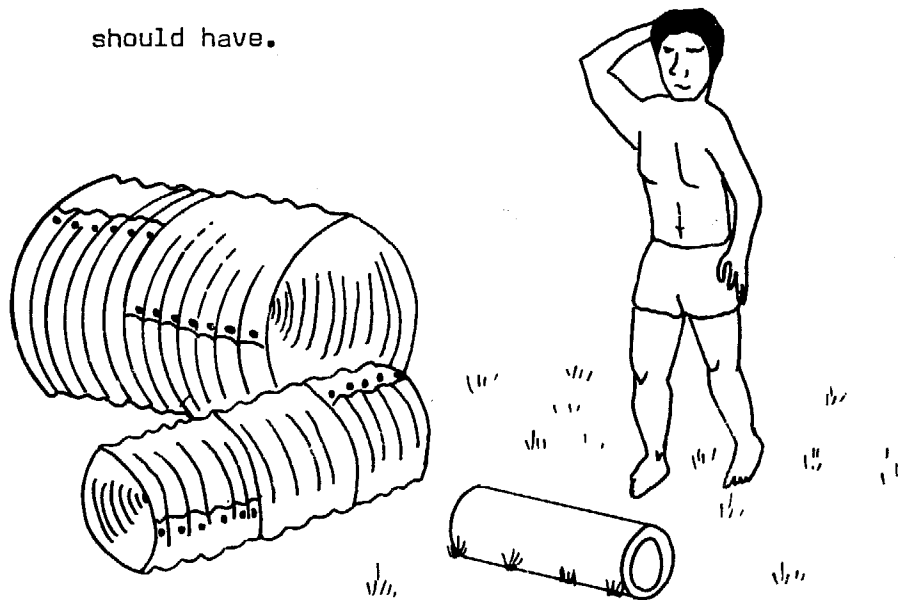

You can work it out like this:

- (a) First look at the banks where the water goes. Look for marks that show the highest place it rises to.

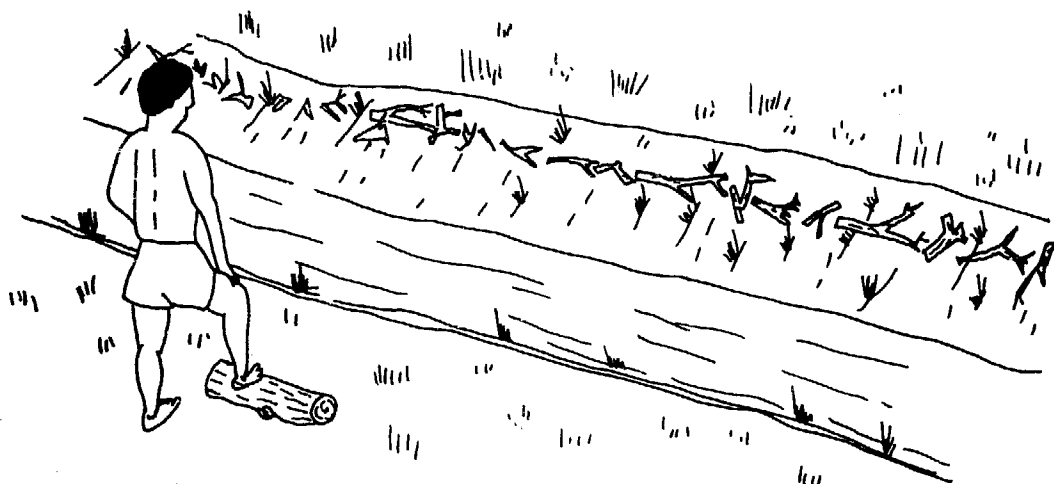

Also, you can ask the Local people how high the water goes. But think about the fact that they may not know, or they may not show you the true place. You want the highest place where the water has ever risen to, not the place it rises to every wet season.

- (b) Second, measure three things:

- (i) Measure the height from the bed of the stream to the place you find where the highest water has ever risen to. I have marked this place (H) for height on the picture.

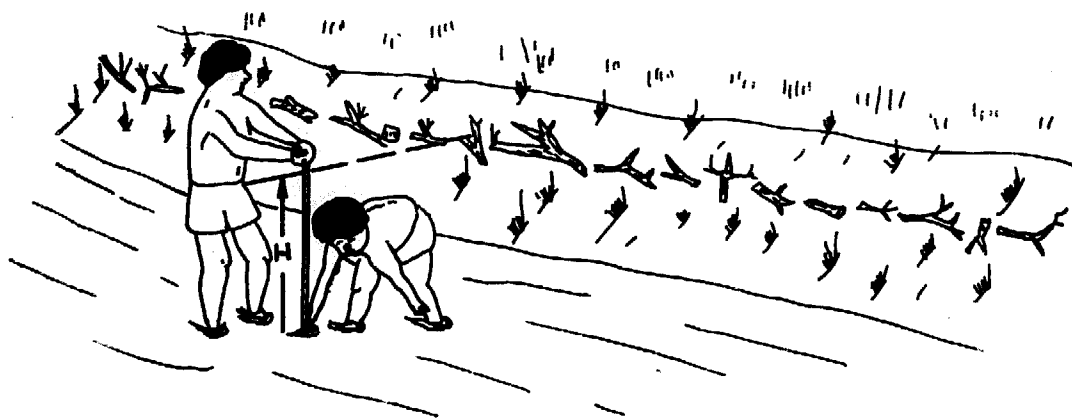

- (ii) Measure the distance from one bank of the stream to the other bank at the highest point. I have marked these two places (B) for bank on the picture.

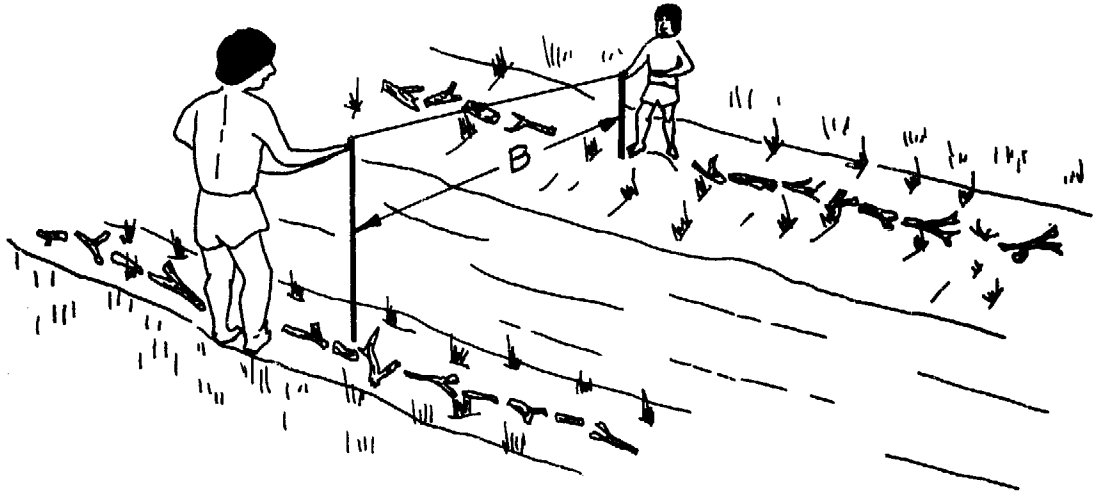

- (iii) Measure the width of the stream bed. I have marked this place (S) for stream on the picture.

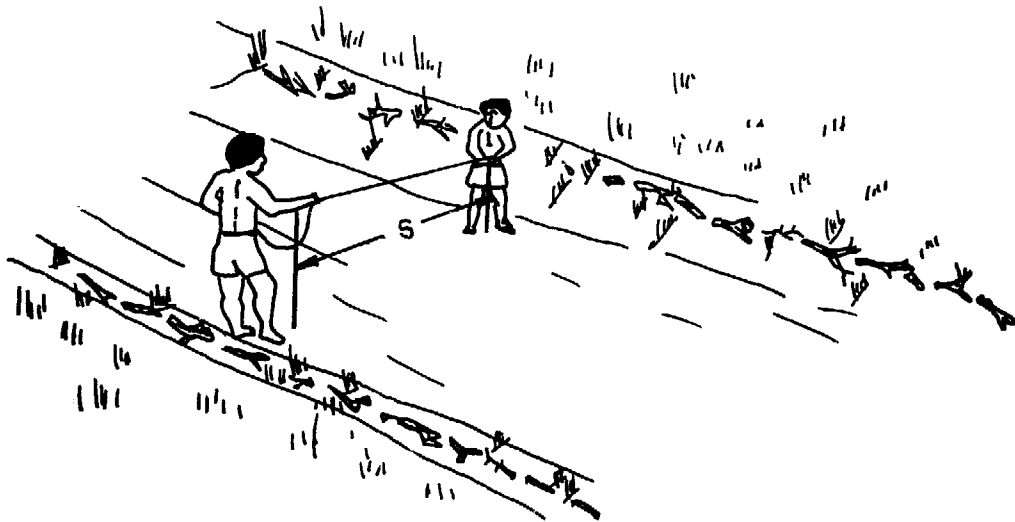

Now you can work out a sum.

You want to know what is called "the area of water way". .

(c) You can work out the area of the water way like this.

- (i) Work out half the height. (In our picture the highest point where the water has ever gone was 1.1m. Half that height is 0.55m).
- (ii) Measure the width from bank to bank at the highest place. (In our picture, this is 4.7m)  
Next, measure the width of the bed of stream (In our picture this is 2.1m).  
Add these two measurements together:  $4.7\text{m} + 2.1\text{m} = 6.8\text{m}$ .
- (iii) The area equals half the height (0.55m in our picture), multiplied by the width from bank to bank (4.3m), plus the width of the stream bed (2.1m).  
Or you can write it like this:

$$\text{THE AREA OF THE WATER WAY} = \frac{1}{2}H (B + S)$$

Now I will fill in the letters with the measurements from the river in my picture:

$$\text{THE AREA OF THE WATER WAY} = \frac{1.1}{2} \times (4.7 + 2.1)$$

$$= 3.7 \text{ Square metres.}$$

- (iv) The area of culvert needed is one half of the area worked out by this sum. That means the area of culvert that you need is half the waterway of the stream when it is in flood.

Area of pipes of different sizes are:-

DIAMETER	300	450	600	750	900	1200	1500	1800
AREA (m <sup>2</sup> )	.071	.159	.283	.442	.636	1.13	1.77	2.55

For Council roads, do not use pipes smaller than 300 mm. or larger than 1800 mm. Take the size nearest to the area you worked out by this rule. Or else, you can use 2 or 3 rows of pipes, side by side, adding up to the area you need.

(v) In the picture we worked out that we needed a pipe with an area that was half of  $3.7\text{m}^2$ . Half  $3.7\text{m}^2$  is  $1.85\text{m}^2$ . Look at the table where it says AREA (m<sup>2</sup>) and the nearest number to  $1.85\text{m}^2$  is  $1.767\text{m}^2$ , and that is a pipe with a diameter of 1500 mm. You should use a pipe of 1500 mm. size or else three 900 mm pipes side by side.

(vi) If you make headwalls of a strong concrete right across the stream the pipes can be smaller - they can be one-third of the waterway instead of one half.

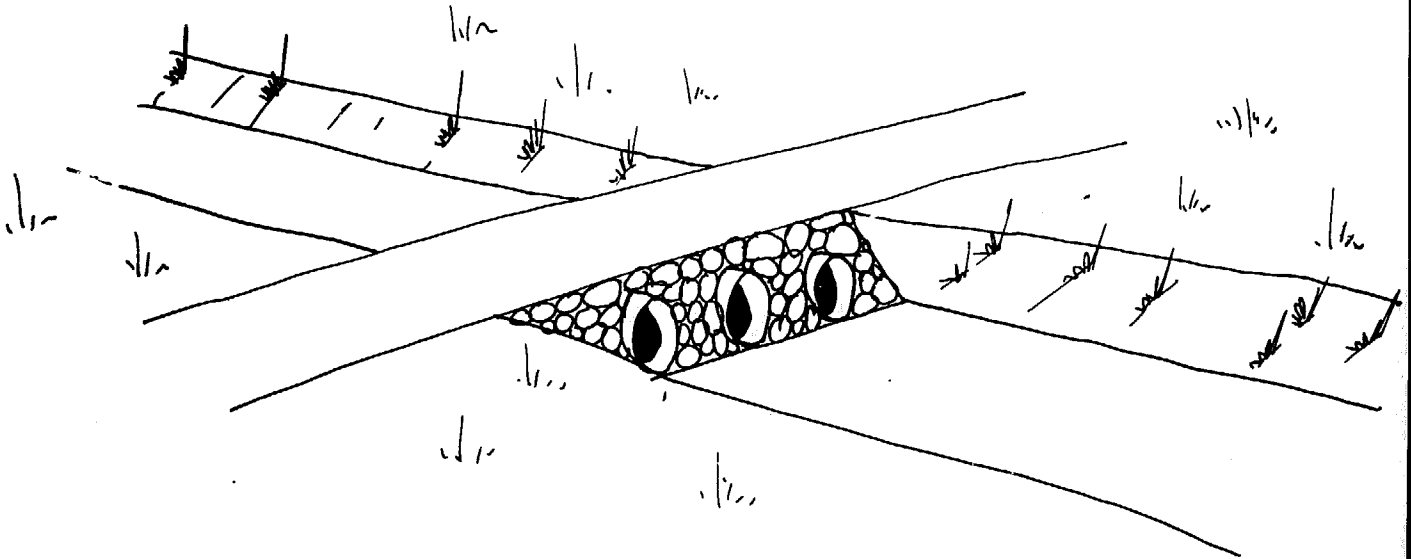

3. How deep should you put the Pipe? For ordinary fill, the top of the pipe should be 1.0m. below the top of the road. But if the fill is good (clay or stone) and is well packed down, you can have less depth, like this:

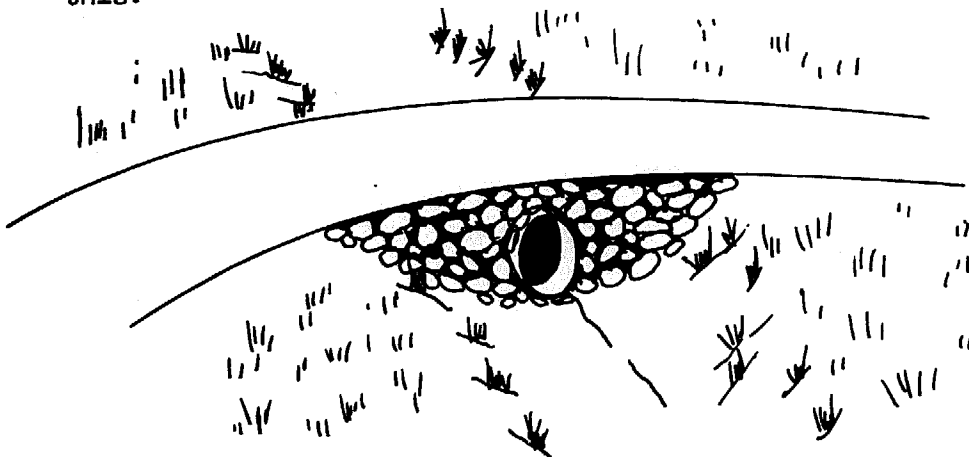

If you use a spun concrete pipe, up to 750 mm diameter, the top should be 0.3 metres below the road.

If you use a spun concrete pipe over 750mm diameter, the top should be 0.6 metres below the road.

If you use a corrugated metal pipe up to 1500 mm diameter, the top should be 0.3 metres below the road.

If you use a corrugated metal pipe over 1500 mm diameter, the top should be 0.6 metres below the road.

This height is measured at the edge of the road. If this height of fill makes a bump in the road, you must ramp the dirt up at a slope of not more than one in 10. Or else, if you use two or three smaller pipes side by side, you might not need a ramp.

4. How to prepare a bed for a pipe: Some streams of water dry up in the dry season each year. Suppose you want to make a culvert for one of these streams, you can do it in the dry season.

Some streams run in the dry season and in the wet season.

What do you do? How can you work with all the water running? You can do one of two things.

Make a wall of sandbags to keep the water away while you dig your trench and lay your pipe.

Here is the second thing you can do:

You can dig a trench for the pipe in ordinary ground. When you have laid the pipe, you can make the stream run through it, and block the place where it ran before.

- (a) How to prepare a bed for the pipe on ground: First you must clear the floor of the stream or trench. Take away all loose material like stones and leaves. Take away anything that sticks up and might damage the pipe, things like sharp rocks and roots of trees. Next you grade the floor of the trench, using boning rods (see page 29). Suppose the ground is swampy, you must put down some gravel next. The gravel should be 0.2m to 0.3m deep. This gravel is a foundation for the pipe.

Next you must lay a bed of sand or some material that is very small like that. You must compact it well (read page 66). It must be at least 0.1 m. deep.

- (b) How to prepare a bed for the pipe on rock. Suppose you must lay the bed on rock, then you should lay a bed of concrete for the pipe. The concrete should be at least 0.1m deep under the pipe. How wide should the bedding be? It must at least as wide as the diameter of the pipe plus 0.2m. If your pipe is 1 metre across the bedding must be 1.2 metres across ( $1.0\text{m} + 0.2\text{m} = 1.2\text{m}.$ ).

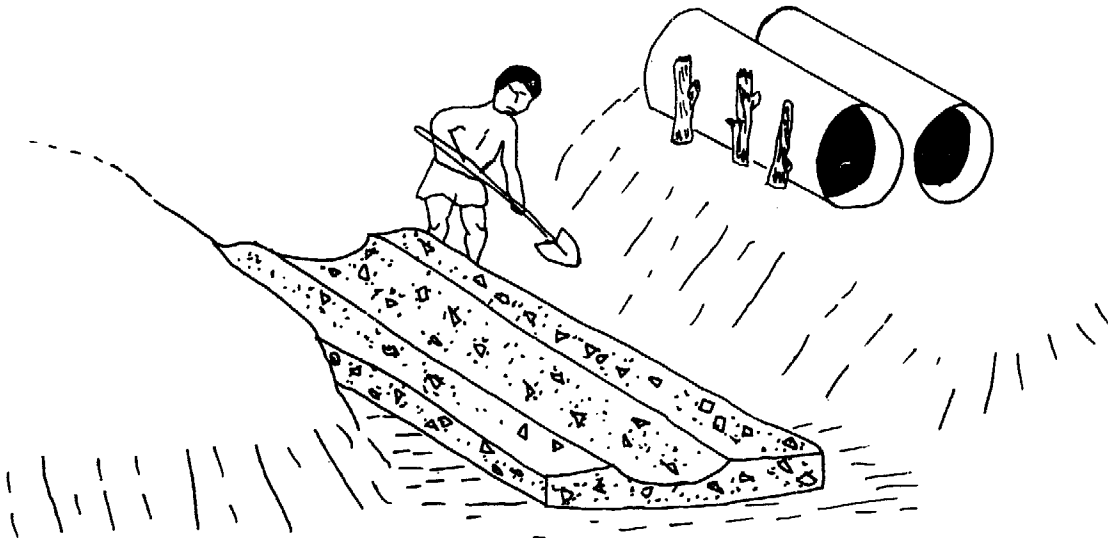

5. How do you lay the pipe?

- (a) Corrugated Metal Pipes: You must read the book that comes from the people who make the pipe. That book will tell you how to put together a corrugated metal pipe from the pieces they send you. Suppose you have to put the pipe in a trench. You can put together the pipe on the ground beside the trench and then skid it or roll it into the trench.

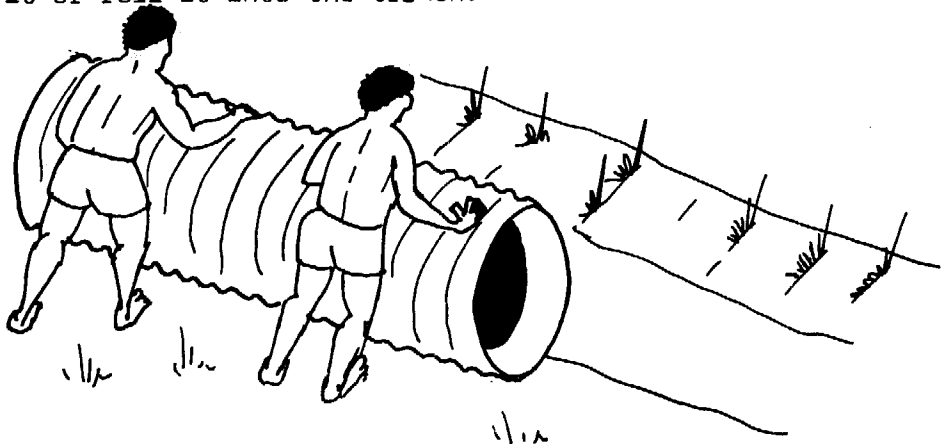

3. The Council says it will get a man called an overseer, or road-master, to look after the work on the roads. They can pay the road-master with some of the Government money.
4. The Council says it will take notice of any talk from its District Roads Board or any of the Government engineers or supervisors. The Council will do what these Government people say they should do.
5. The Council says it will pay compensation to people who hurt or killed on roads because of maintenance work or mistakes that the Council made. The Council must get insurance to pay this compensation.

Suppose there is trouble between the Council and the Government. They must talk about the trouble at the District Roads Board meeting. The Government will try to help the Council get over any trouble. BUT suppose the Council does not try to do a good job, then the Government will not pay the grant money.

Remember, if the Council says it will not maintain the Feeder Roads, then these Feeder Roads will soon get very bad and trucks will not be able to drive on them.

Now, if you work for a Council, you should be able to find out from the Council Clerk, what are the Feeder Roads in the Council's area.

#### F MINOR ROADS

The Government does not give road maintenance funds for smaller roads. These smaller roads are called minor roads. There can be two types of minor roads:

(i) Council roads:

Suppose the Council says it will maintain a minor road.

The Council must use Council money.

BUT from 1975/76, Councils can also ask for a grant of money from the Rural Improvement Programme, to help with maintenance of these roads. It would come in a one big amount, and the Council would decide where to spend it.

(ii) Non-Council Roads.

Suppose the Council says it will not maintain a road, then the people who live on the road will have to maintain it for themselves.

If the people do not maintain it, the road will soon get too bad for any trucks to use it.



First , you must put more sand under the pipes and pack it tight or ram it tight to the height on the picture -

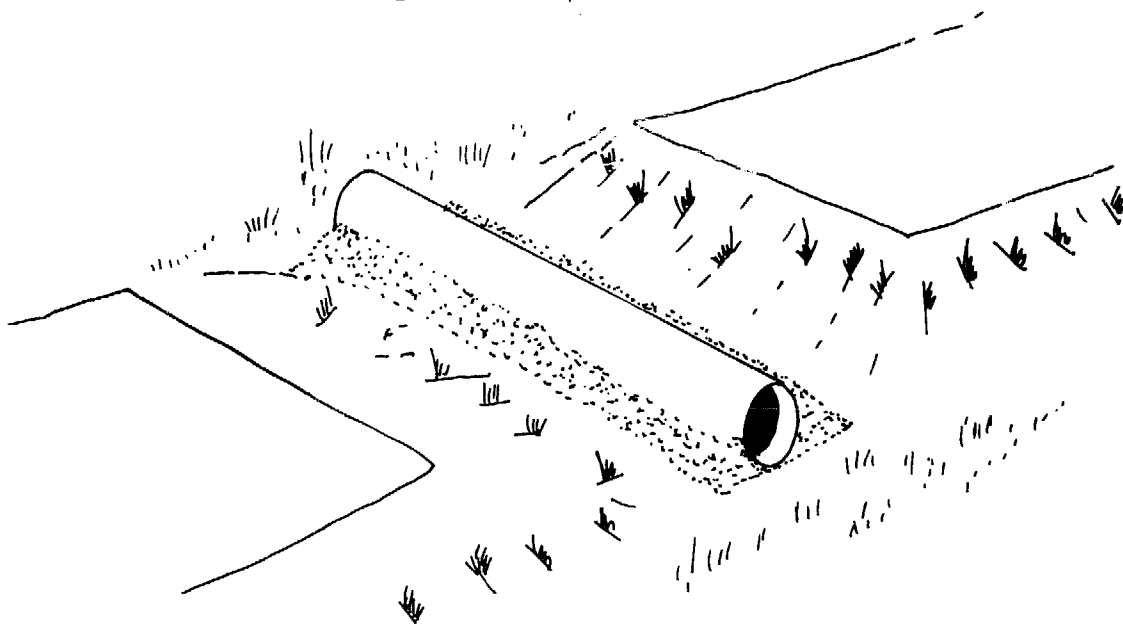

If the pipe is on rock, you must pour more concrete up to the same height.

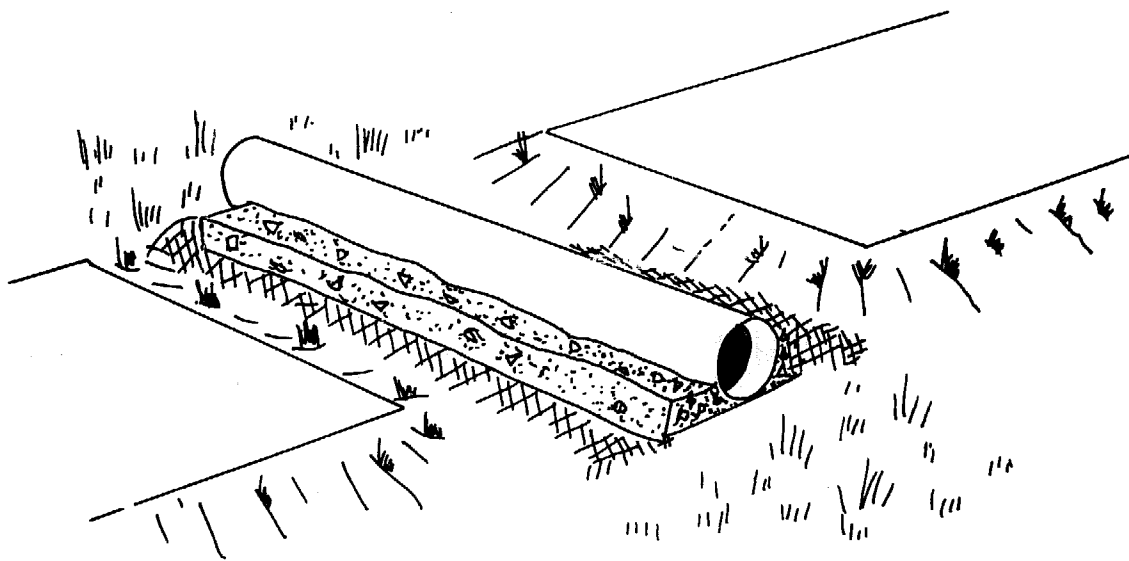

Next you must put down fill. You put down a layer of material 0.2m deep. Then you compact the layer of material (see page 66). Then you put another layer and compact it. And so on. You do this until the compacted fill is at least a quarter of the diameter above the top of the pipe. See the picture on the next page showing this.

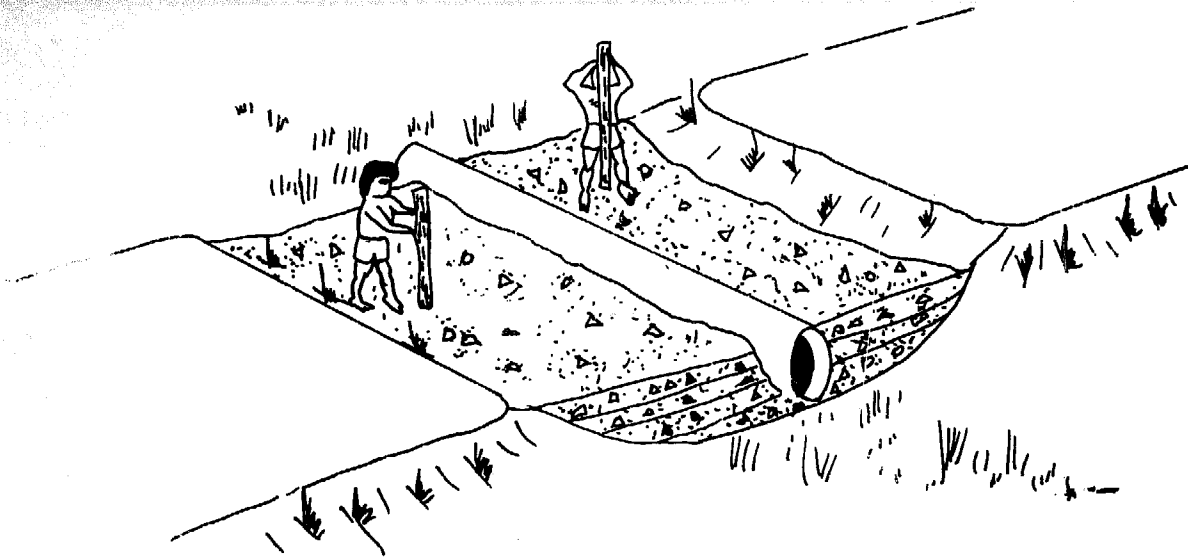

You put down fill and compact the fill until you have compacted fill on both sides of the pipe. The measure of the fill on each side is the same as the measure of the diameter of the pipe.

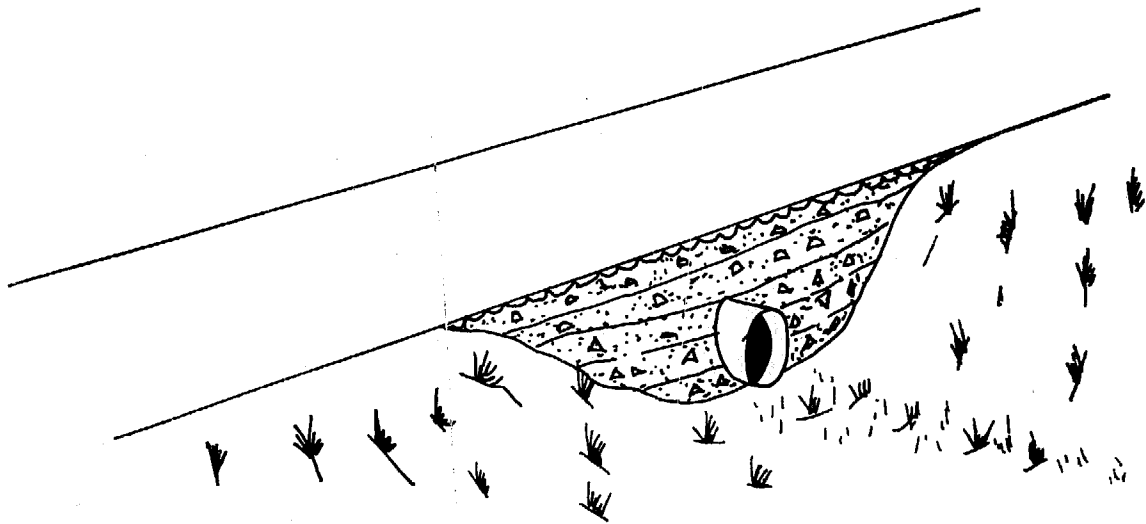

Suppose your pipe is in a trench, you must put down fill and compact it to the sides of the trench.

What material do you need for the fill? The fill material next to the pipe must be good. The material must first have big stones. The stones must not be more than 50 mm. across. You can use sand mixed with a little clay silt from the stream. This is easy to compact. It is very important to use this good fill material close to the pipe. It is very, very important when the culvert is under deep fill. You must supervise this part of the work very carefully. When you have finished compacting this good fill close to the pipe, put down the rest of the fill. It must be well compacted. It must be very well compacted in wide stream beds.

## 7. Headwalls

Why do you need a headwall?

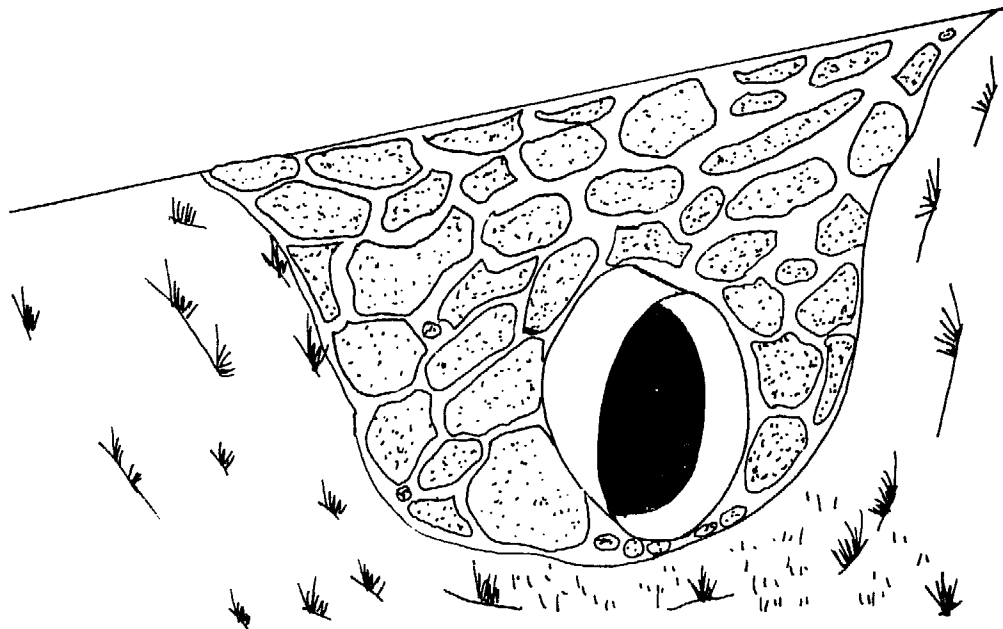

As you can see in the picture an ordinary headwall is made of big stones with cement put all over it to make it strong. This sort of headwall has a big name. It is called "a cement grouted stone pitched headwall". You need a headwall to prevent the fill from scouring or from collapsing. The fill must not scour or get washed out. It must not collapse.

Where must you construct a headwall?

You must construct a headwall at the place where the water goes into the culvert and the place where the water comes out.

See the pictures on the next page for this.

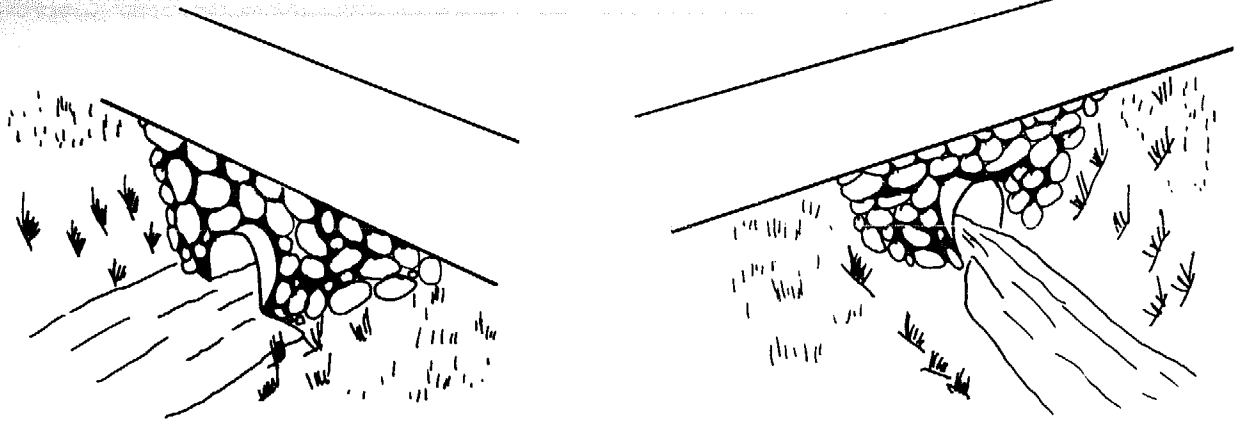

How do you make a headwall? Usually a headwall should go up only to about 0.3m. above the top of the pipe.

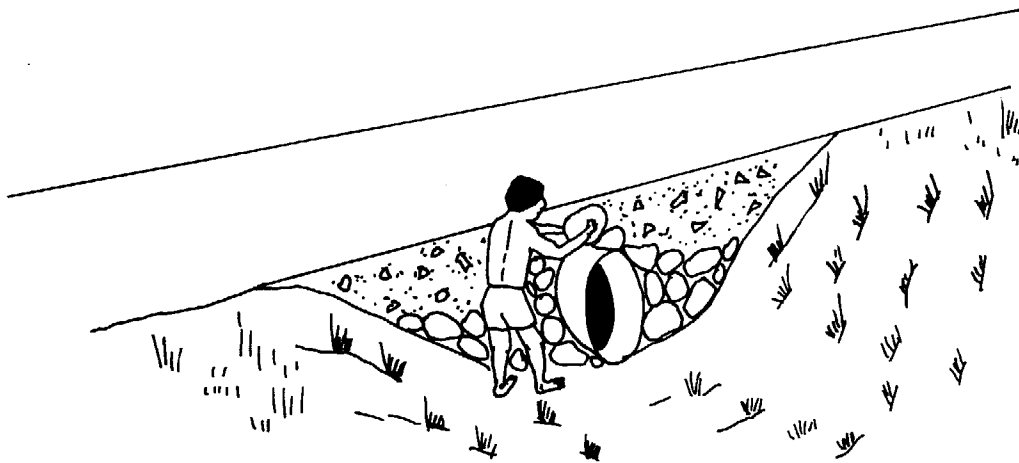

But you can ask the Local Government Supervisor about a special headwall. He may design a special strong, high headwall for your culvert. With a special headwall, the fill slope can be shorter and the pipe can be shorter, too. The Local Government Supervisor may also tell you to use reinforced concrete or wire baskets filled with stones (these baskets are called "gabions"). These ways of supporting the fill cost a lot of money. Do not use them unless the Local Government Engineer advises you to use them.

8. Aprons

How to protect the place where the water flows out of the culvert with a concrete apron. When water flows out of a pipe, it does not spread.

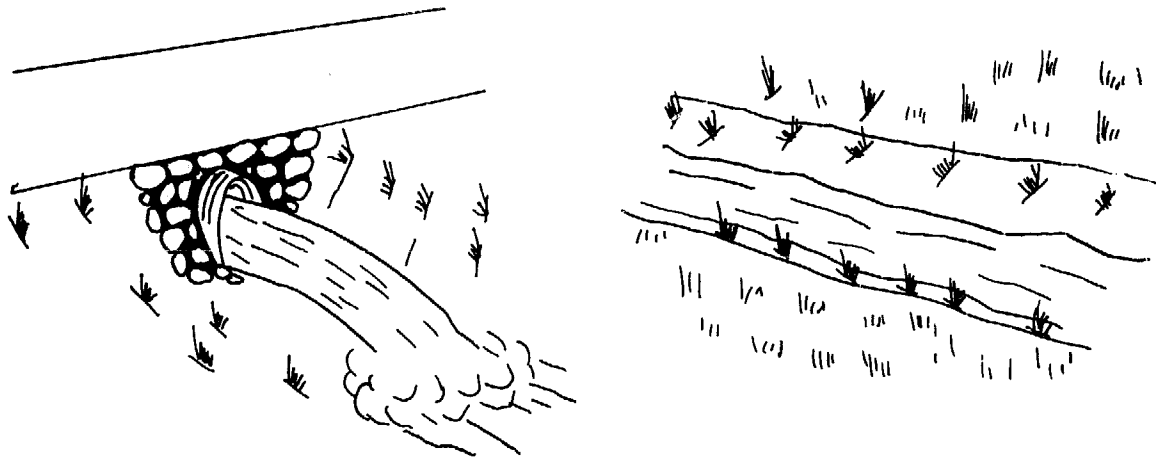

When water slows down it causes erosion. When water flows down a steep hill and then through a pipe it causes a lot of erosion. You must often have a look at the place where the water flows out. If you can see that the water will cause erosion, you must make an "apron" at the place where the water flows out.

An "apron" is a pad of concrete. It is about 0.2m thick. It has this shape.

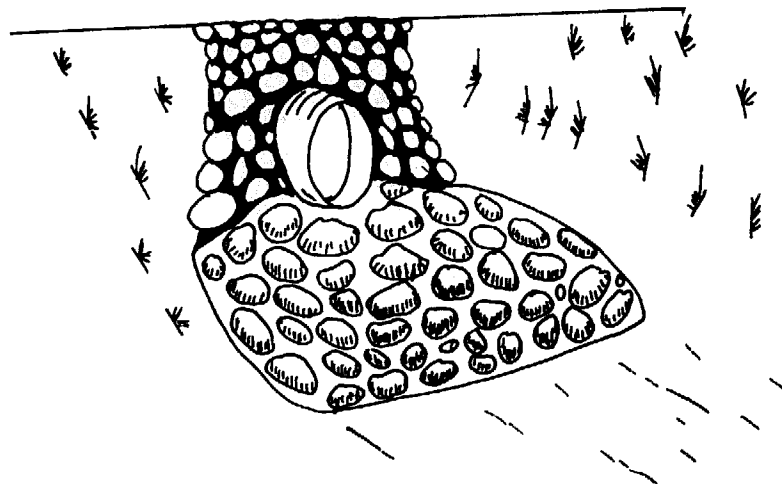

You must make the concrete with a lot of stones in it. The stones will break the flow of the water from the pipe. The stones should be big enough to make the water spread out.

Sometimes the water drops down from the pipe like this:

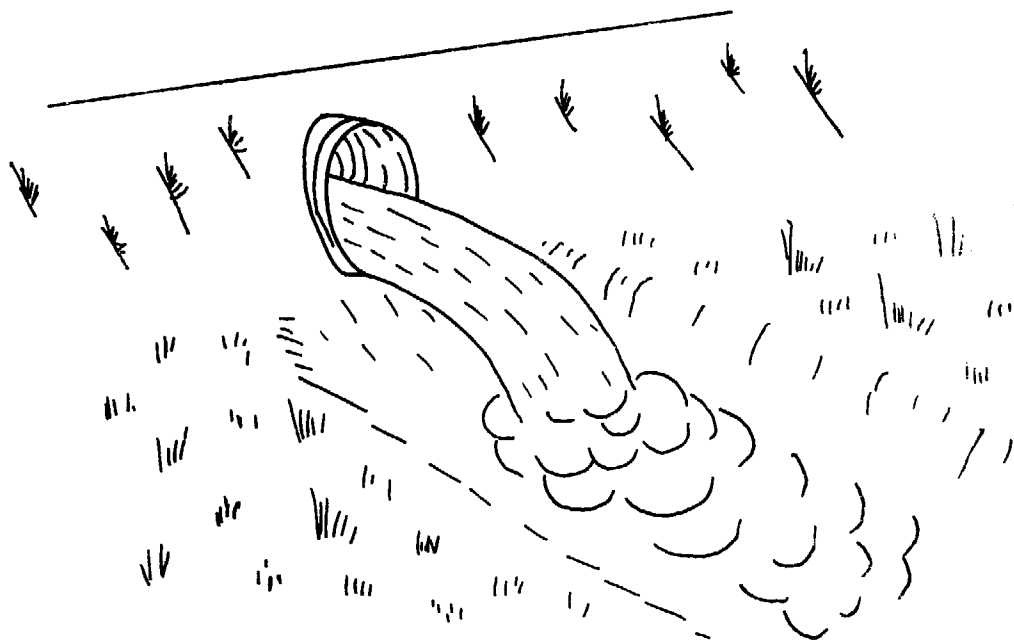

This water falls with a lot of force. It can make the bank collapse. It can wash away the fill under the pipe.

This is very bad. You must place large stones in the pit that the water made under the pipe outlet.

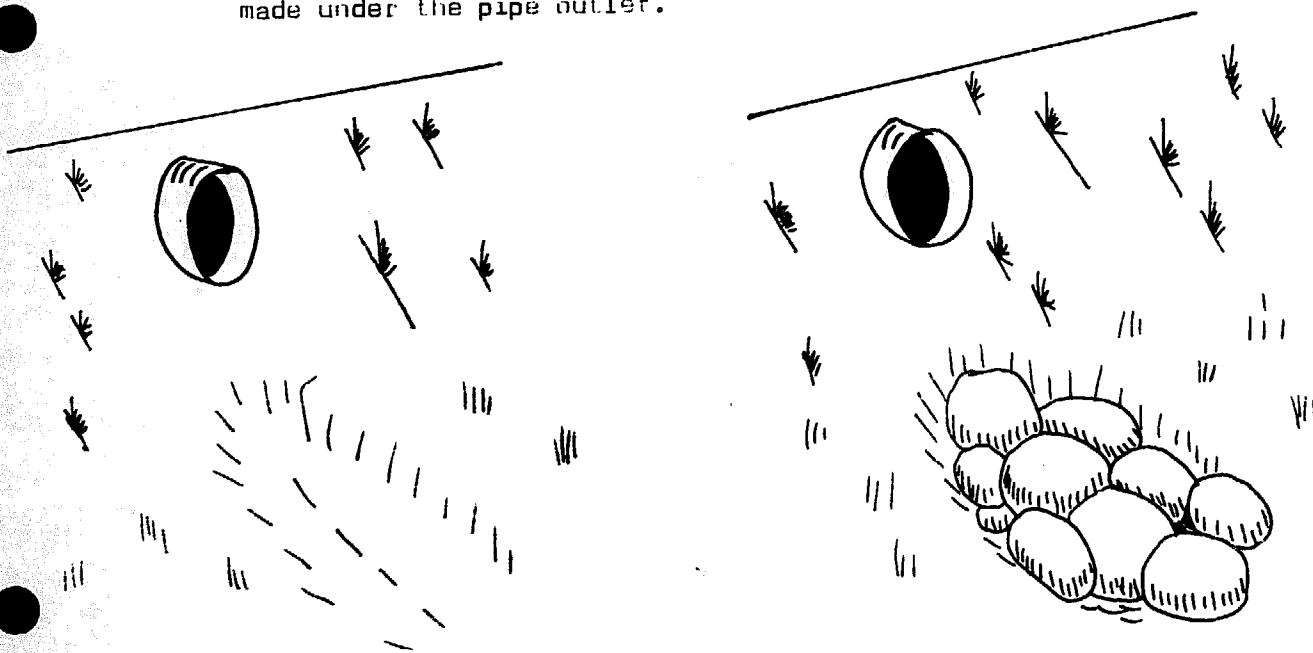

The bark should not be taken off, except if there is fill to be held back. If there is fill the sill-beam must be cut to shape ("stepped") where the stringers rest on it. Walls at the side of the abutments are called wing walls, are shown in the drawing at the back of this book. They are used to hold in the fill so the road does not slip down.

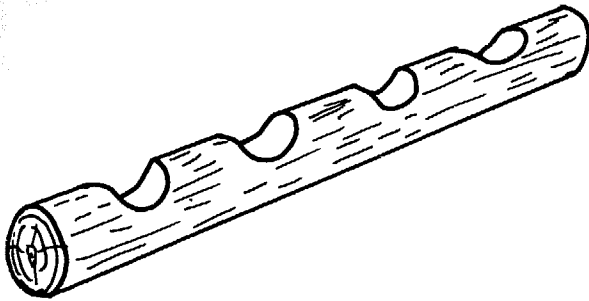

Stepped Sill-beam.

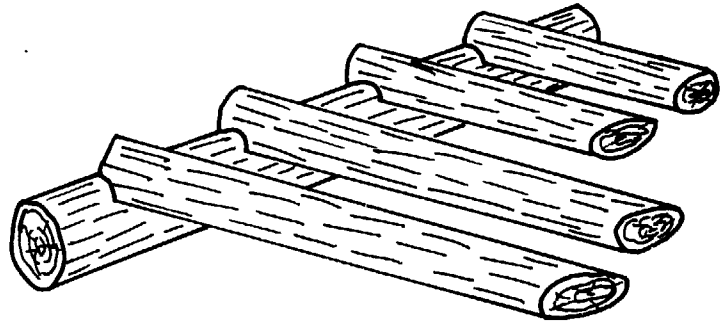

Sill-beam with stringers.

Here are the two types of wing wall that you can use:

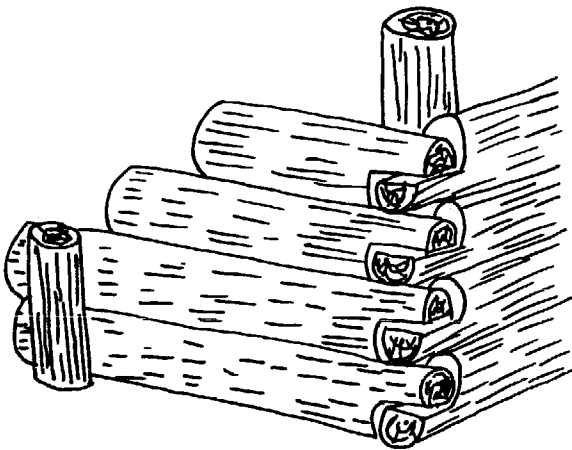

Wing Wall Type W1

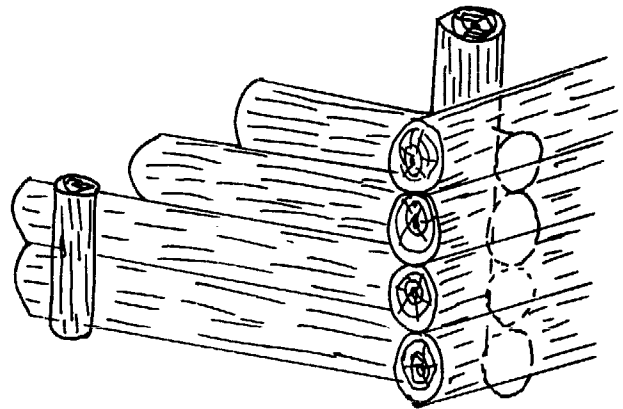

Wing Wall Type W2

These are the same, except W1 is bolted to the retaining wall logs (horizontal); W2 to the piles (vertical).

Bolts must be used for all abutments to keep the structure firm and strong. You can get bolts up to 600 mm. long at Government Stores. Longer ones can be made by threading steel rods in a workshop.

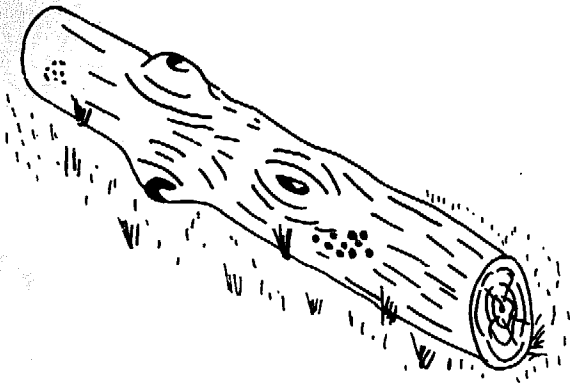

This is a picture of a bad log.

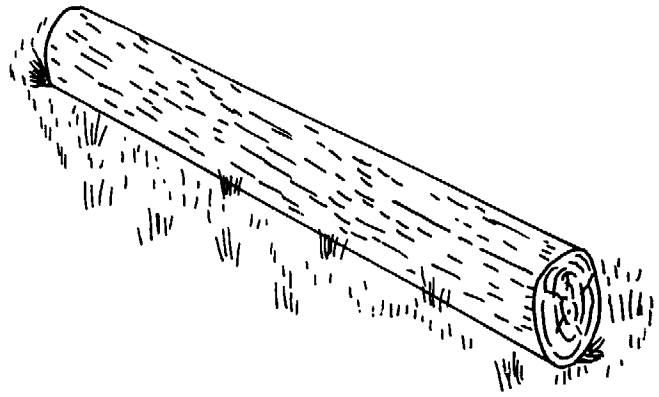

This is a picture of a good log.

3. How big must the timber be?

Strength Group of logs.	Diameter (mm)	250	300	375	450	525	600	675	750	825	900
		Longest spans of logs for different diameters (metres)									
A		3	4.5	6	9	12	15	18	21	24	24
B		-	3	4.5	6	9	12	15	18	21	24
C		-	-	3	4.5	6	9	12	15	18	21

Different strengths of types of wood in Papua New Guinea.

Strength Group A

1. Kwila
2. Kassi-Kassi
3. Hopea - heavy
4. Manikara

Strength Group B

5. Hopea- light
6. Geijepa
7. Heritiera
8. Vitex
9. Garo
10. Hopea - heavy

Strength Group C

11. Yellow Hardwood
12. Dysox
13. N.G. Beech
14. Kamarere
15. Water Gum
16. N.G. Oak
17. Taun
18. Anisoptera



4. How do you measure the log?

The diameter measure does not count the bark. You must measure the thinnest section of the log.

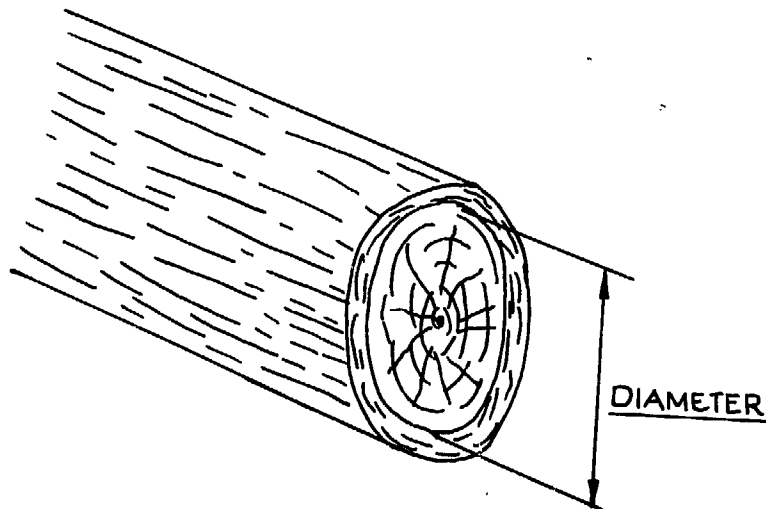

Note: The stringers (mainbeams) must not be smaller than I have told you. Suppose the diameter of the stringer is 10% less than I have written in the list. The bridge will be 30% weaker. Instead of 10 tons, it could carry 7 tons.

The timber for the deck of the bridge is fairly easy to replace. But the stringers and abutment timber is very hard to replace. You do not want the stringers and abutment timbers to rot.

5. How do you prevent timber from rotting?

Try not to disturb the bark on the logs. Also, paint the timber and add creosote or coal tar or sump oil before you start to construct the bridge. You can ask the Department of Forests if they can help you. Sometimes they can help you by treating the timber in a special way by chemicals or in a pressure tank. But they usually cannot do this.

Final test for each log to know if it is a good log: You must get a man to lift up one end of each log. You must hit the log with the back of an axe or with a sledge hammer. A strong log will make a strong, clear sound. A rotten log will make a different, dull sound. You can tell these two different sounds when you have heard them a few times.

6. How high should a bridge be?

Usually a bridge is higher than the place where the river floods to in the rainy season.

The bottom side of the bridge should be 1 metre higher than the highest water level.

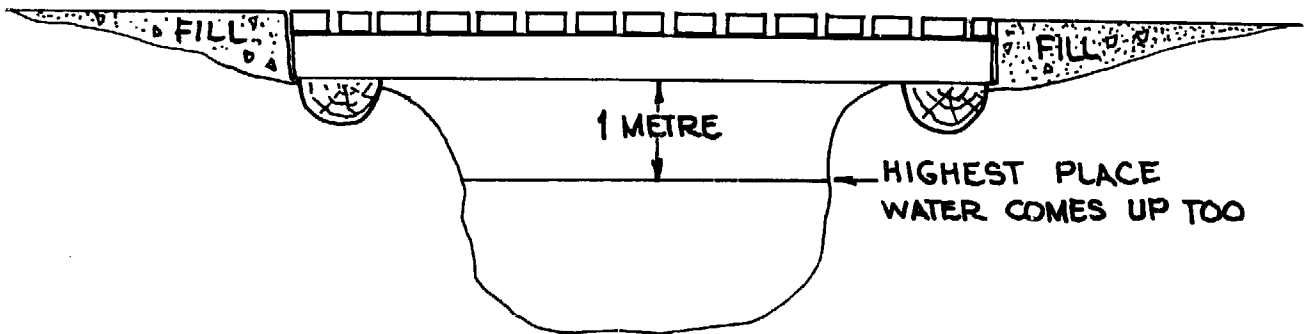

You may have to raise up the road to this height. You call this an approach embankment.

You can read pages 55 to 57 to find out how to construct an embankment. An embankment across a swamp and an approach embankment are made in the same way. Suppose you have to build this approach embankment across a flood relief plain. A flood relief plain is where the water spreads out over flat ground alongside a river in flood.

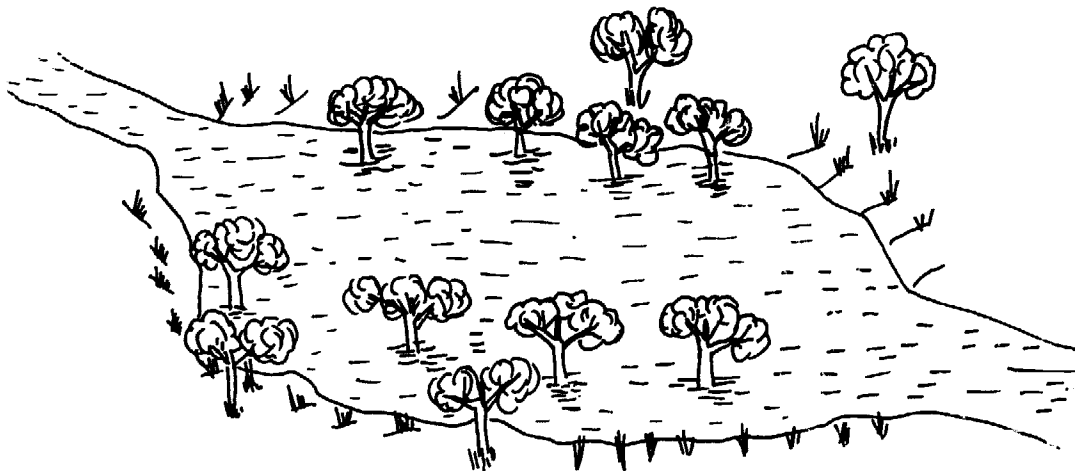

Suppose you stop the flood water from flowing easily. The flood water might erode your bridge or even make it fall down. So you must be careful when you build a road across a flood relief plain. The road must be a low road and you must grade the approach embankment at about 8% to 10% gradient.

7. Abutments:

What is an abutment? It is the foundation, built on each bank, for a bridge to sit on.

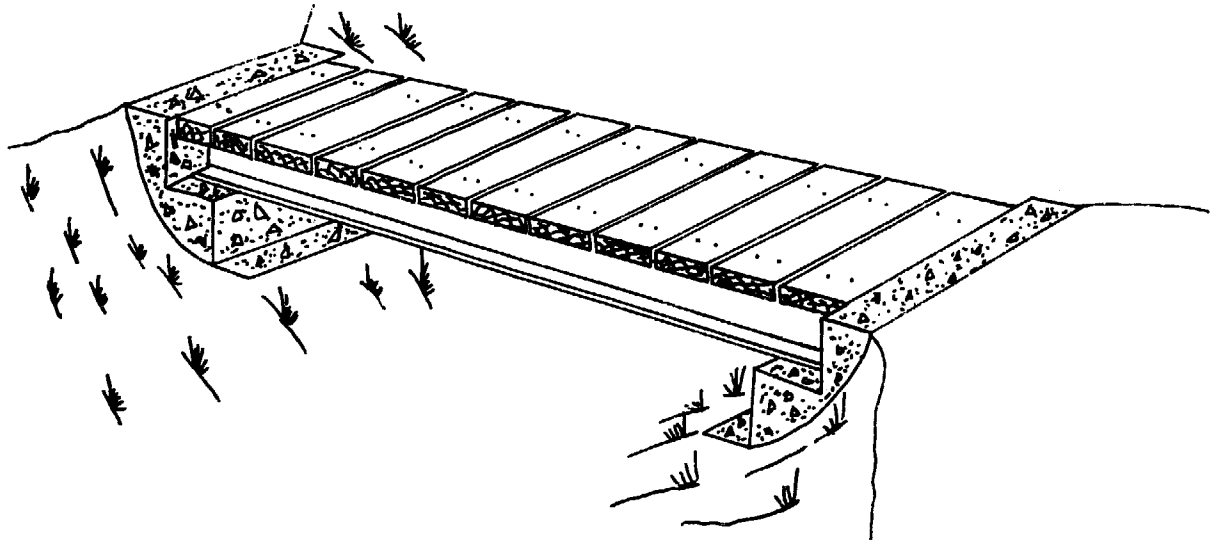

Suppose the abutment to a bridge is badly constructed or suppose it is not big enough. The bridge may break or sink down. Heavy trucks cannot use the bridge. You must construct a good big abutment the way I will now tell you.

- (a) Concrete abutments are the best abutments. Suppose you do not have lots of good timber in your area - then concrete abutments are also the cheapest sort of abutment.
- (b) Timber log abutment
- (c) Gabion abutment
- (d) Steel pile abutment
- (e) Steel pad abutment

Here are 4 important rules for bridge abutments

- Rule 1: Bridge abutments must be stable - they must not shake when a truck goes on the bridge.
- Rule 2: Bridge abutments must not break when a heavy load goes on the bridge.
- Rule 3: Bridge abutments must be constructed so that the fill behind them does not spill out and so it does not get scoured out.
- Rule 4: Bridge abutments must last as long as the stringers without breaking.

Timber abutments for timber bridges: Timber abutments are the cheapest to build and can be replaced sometime in the future when a permanent materials bridge is built.

Here are 3 good sorts of abutments for timber bridges.

Abutment Type A: a retaining wall abutment to go with bridges that are less than 18 m. long.

(Abutment A is NOT good for a longer bridge. It is not stable enough)  
The fill behind the abutments must be good material. It must be compacted well (see page 66).

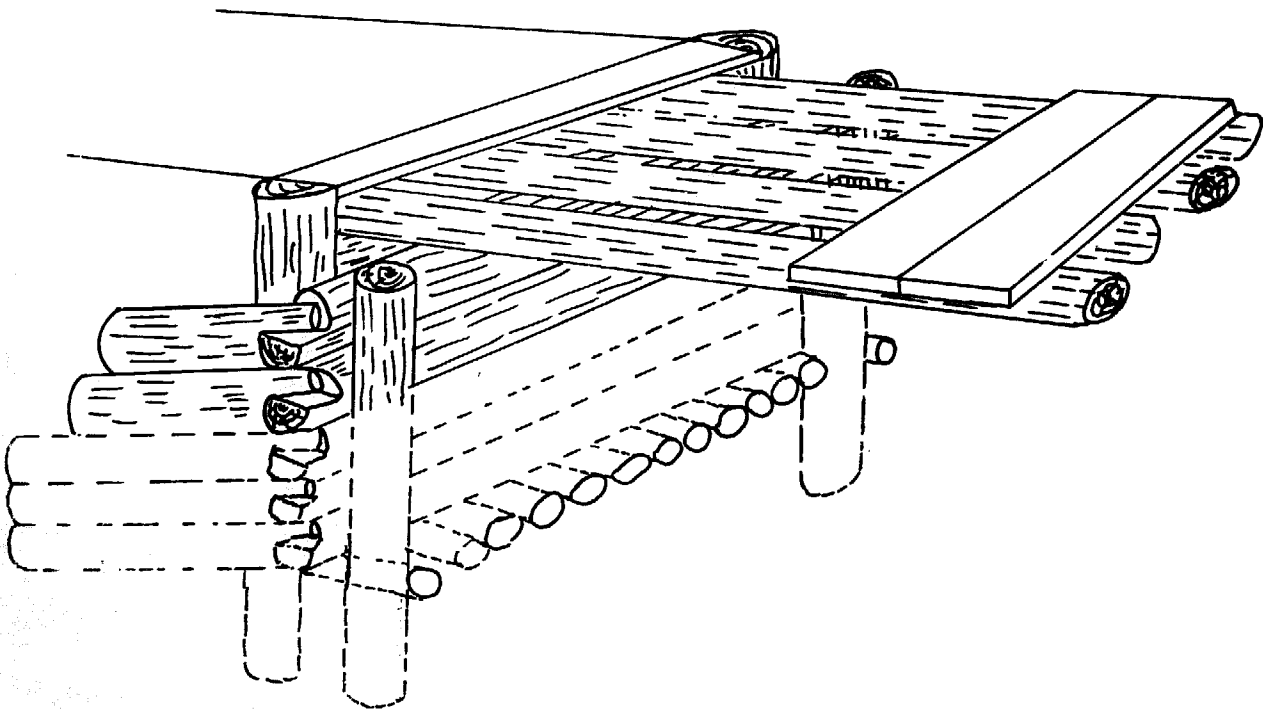

110  
Abutment Type B: a stronger, more stable retaining wall abutment that you can use on bridges 18 metres and longer.

In this abutment you must put stakes close behind the abutment wall to keep in the fill. You can fill behind the stakes in the same way as you fill behind Abutment A.

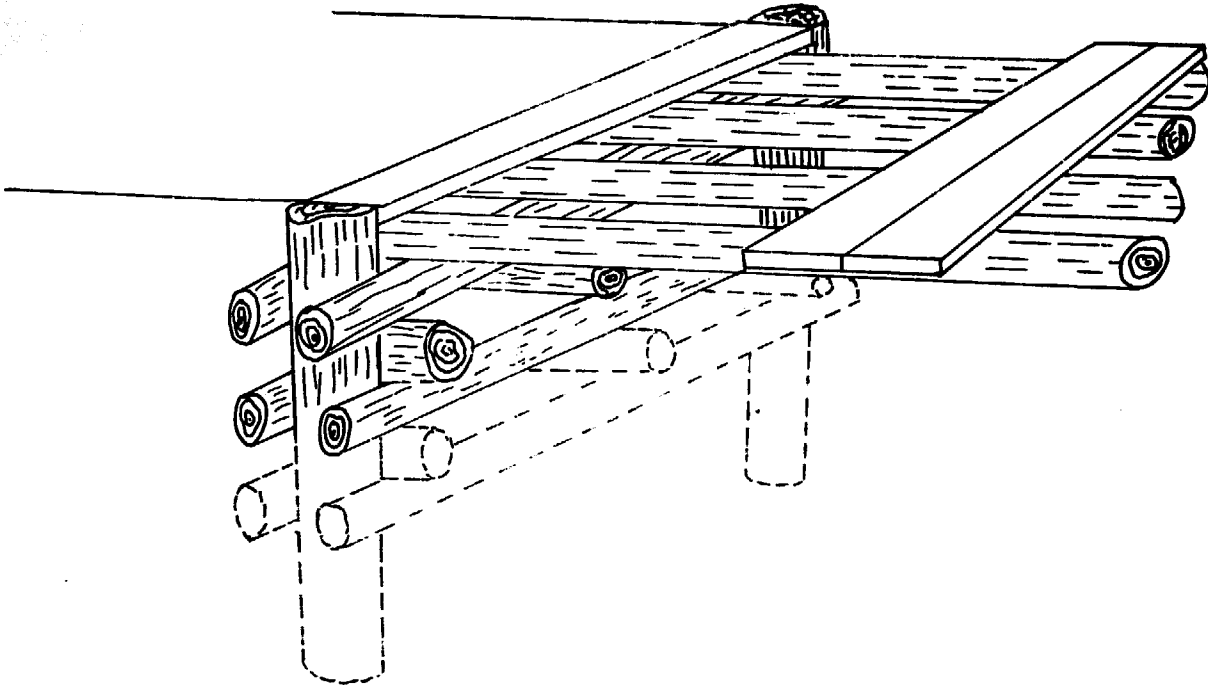

Abutment Type C: a simple piled sill-beam abutment. This is the best sort of abutment.

If you cannot make a concrete abutment, then this is the best abutment to use for a log bridge of any length.

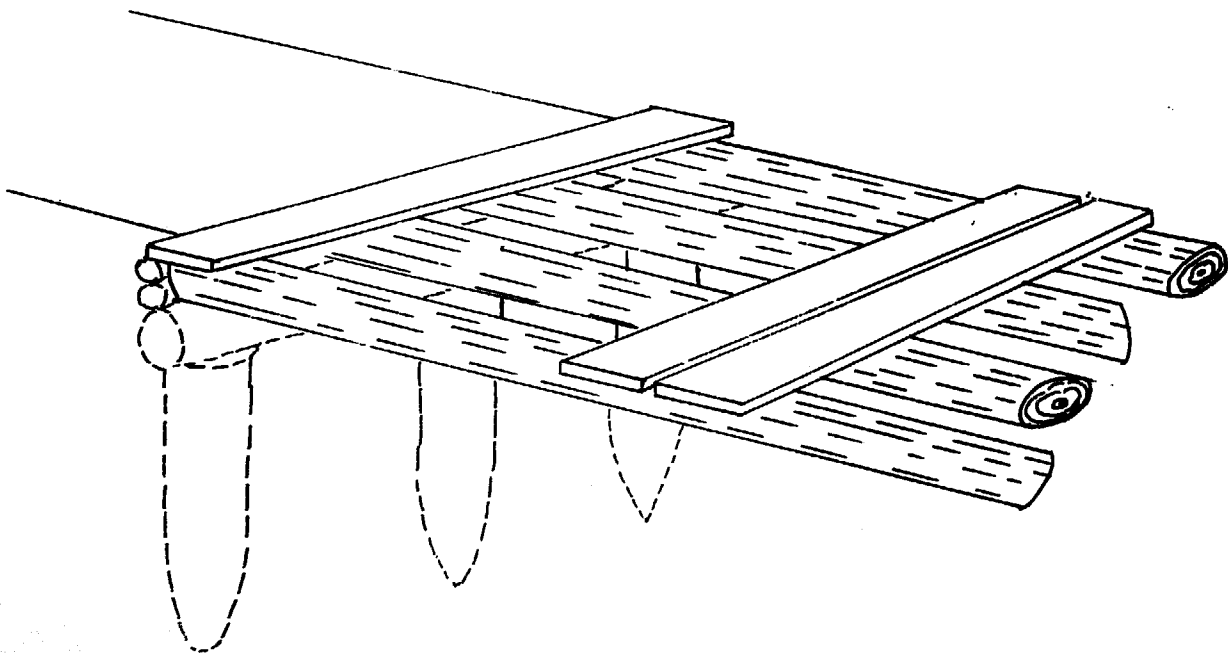

I will now tell you how to construct a piled sill-beam abutment.

First, you dig a trench in the right place for the big beam that holds up the stringers. This beam is called the sill-beam. Suppose the ground at the bottom of the trench is not strong (that is, suppose your foot sinks in when you stand there). Then you should drive three poles (piles) three feet down into the bottom of the trench, (less if the ground gets too hard to hit them in). Then cut off their tops at the bottom of the trench.

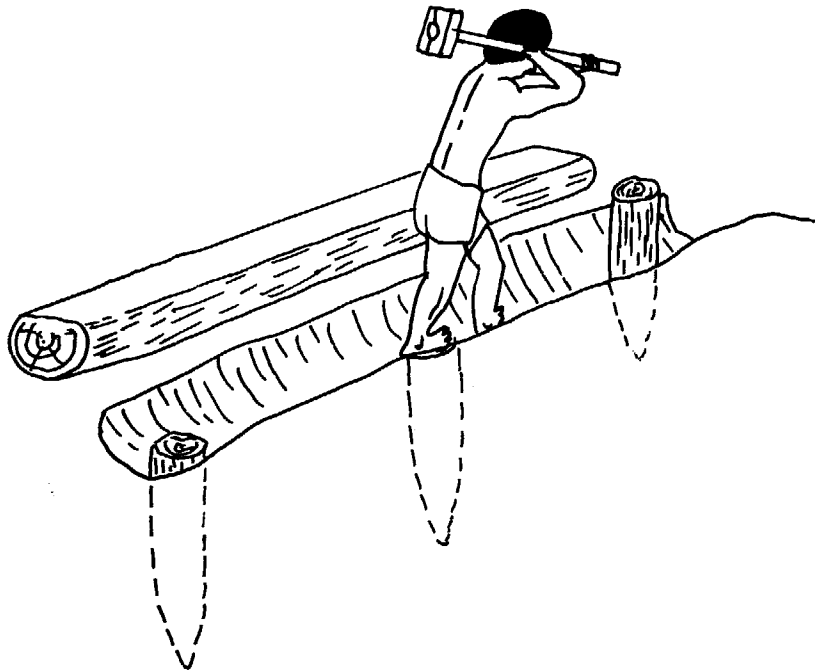

Put the sill-beam in place, pack good fill all round it, then the stringers can be put on top of it and bolted into it with steel bolts or bars.

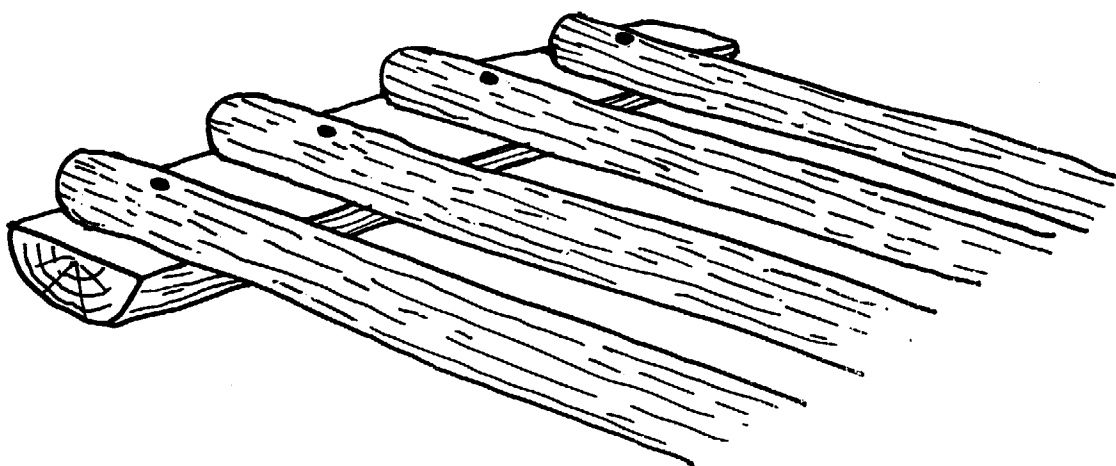

How deep should the stones be in this pit? Suppose the pipe is a small pipe (300 - 900 mm diameter). The stones should be at least 0.3m deep. Suppose the pipe is a big pipe. (1200 - 1800 mm diameter). The stones should be 0.6 m to 1.0 m deep.

How big should the stones be? The stones must not move when water comes quickly out of the pipes. They must not move even when a lot of water comes out in the rainy season. If the pipe is a big pipe, the stones will have to be heavy and strong because the water must not make them move even in the rainy season when a lot of water comes down.

## B. TIMBER BRIDGES

### 1. First words:

I will tell you how to make log bridges out of trees, I will not tell you how to make steel bridges. You need an engineer for steel bridges. A log bridge is a temporary bridge. It does not last for a lot of years. But you must construct a good log bridge because you want a strong bridge, a safe bridge, a bridge that does not cost much to maintain. Also if you live in a place where there is not a lot of timber for bridges, you do not want to waste timber.

### 2. What timber do you need for bridges?

The most common good timber for log bridges is Tagarūba. This tree has two other names - It is called New Guinea Beech in English and Forestry Officers call it Nathopagurs. Other timbers can be used. Some other timbers that can be used are Kwila, teak, hopea, ksasi-ksasi, manilkara or other good strong hardwoods. You can ask Department of Forests to tell you about other good timber for log bridges. You must look at each log. Each log must be straight. It must not have twists or knobs or stakes. It must not have insects in it or places where white ants used to live.

Suppose you use bad timber, heavy trucks cannot use the bridge. Also the bridge will not last. See the pictures on the next page that show you what good logs look like.

Stringers with Abutments A and B: You must step the stringers onto the sill-beam and bolt them securely to the sill-beam. These two things are important. Why must you do this? Because it makes the bridge more rigid or strong. Also it prevents the top of the abutment from being pushed into the stream because of heavy weight of the fill behind the abutment. You must protect the wood that has been cut on the sill-beam. You protect it by putting a strip of Malthoid between the stringers and the sill-beam. (Malthoid is a special flooring with tar on it. You will find it in the Government Stores Vocabulary under Class No. 5640). All bolts must be counter sunk. These are counter sunk so that the tops do not stick out of the wood. See the pictures below showing some Malthoid between the stringers and sill-beam and a counter sunk bolt.

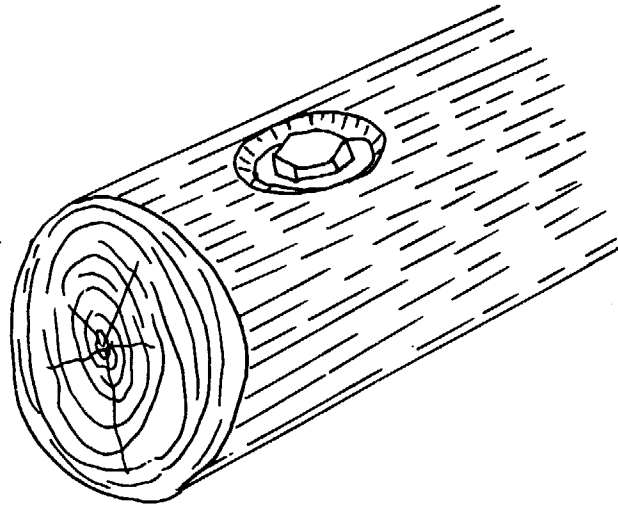

Where bolts have been counter sunk, you must fill the holes with caulking compound or something like tar so that the water will not fill the holes and so the water will not make the timber rot.

Stringers with Abutment C: Usually you do not need to bolt or step the stringer onto the abutment. But suppose you use an Abutment C with a retaining wall abutment, then you need to step and bolt the stringer as I told you before. Do NOT make the abutment piles on the corners of bridges longer, so that you can use them for guide posts. This is very bad. Suppose a truck hits the post, the abutment may be badly damaged. You need separate posts as guide-posts.

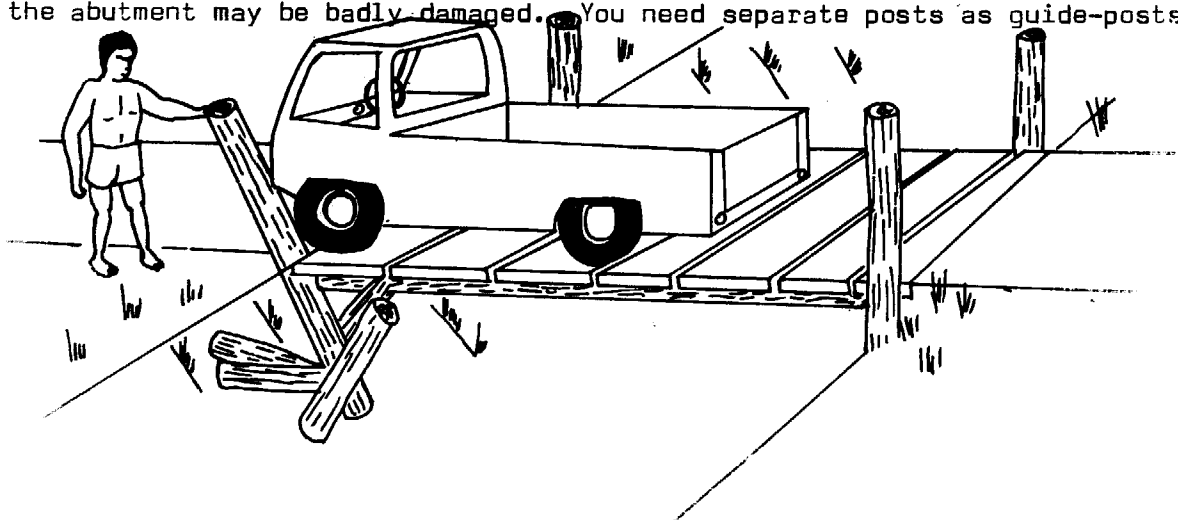

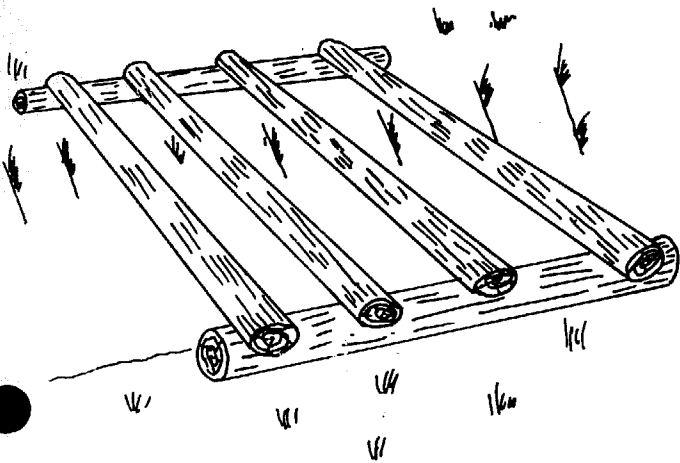

8. Stringers and Decking:

This picture shows 4 stringers on a bridge that is being built.

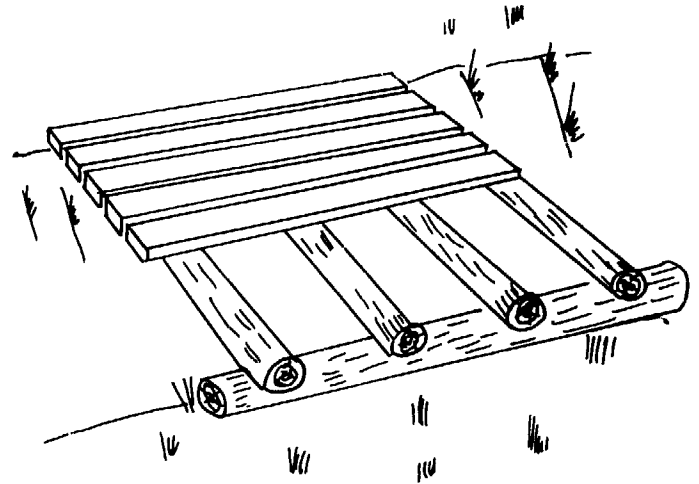

This picture shows the half completed deck on the 4 stringers.

You do not need more than 4 stringers. You cannot make the bridge stronger by using more stringers.

The best sort of decking is sawn timber that has been treated with Creosote or something like that. The decking should be 200 mm x 100 mm. But this is hard to get.

Here is another good sort of decking. Get 200 mm. x 75 mm. decking and spike it to the stringers. Spikes are big nails 6" long or longer. On top of this put 200 mm. x 50 mm. running planks and coach bolt the running planks to the decking.

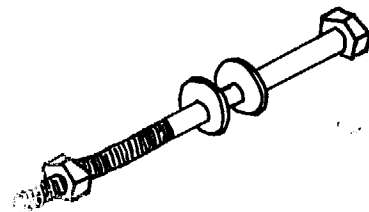
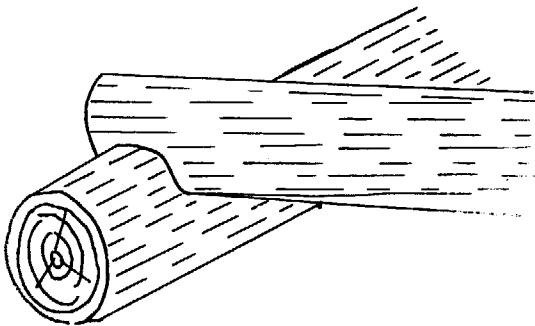

Do not spike the running plank to the decking. This is very bad. It soon comes loose. The decking must be spiked to the stringers. Use packing where necessary to fill the holes.

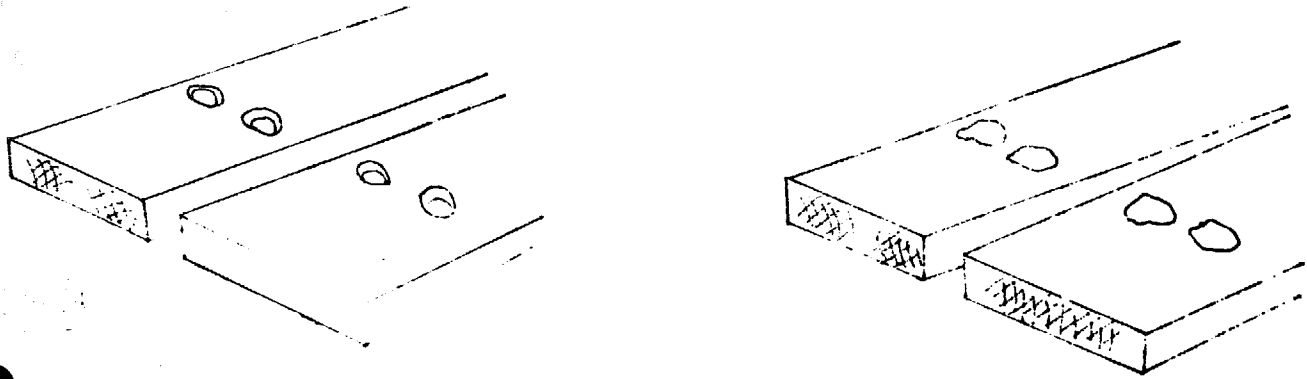

You can flatten the top of the stringer and protect it with Malthoid if you want to.

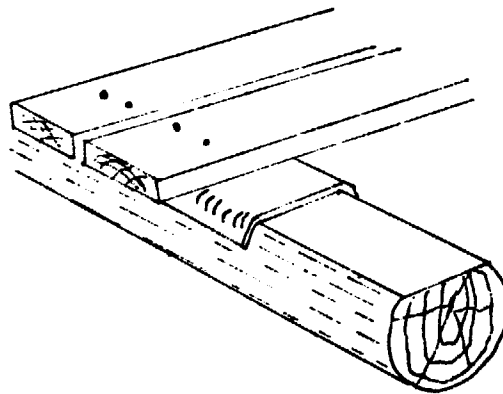

OR: You can leave the bark on the stringers and nail the decking straight onto the stringer.

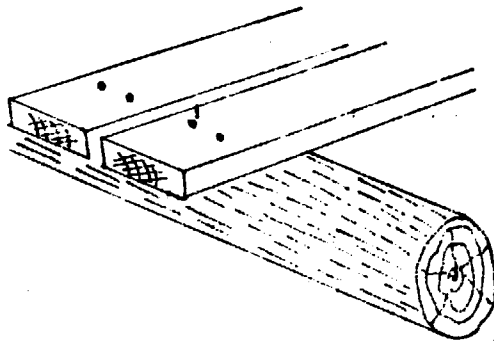

You must not put clay or coronous on top of the decking to make it smooth. Why not? Because they hold water and make the timber rot quickly. Also, they are too heavy and the bridge will not be as strong as I told you before on page 105.

9. Kerbing:

You must spike a kerbing onto the bridge like this:

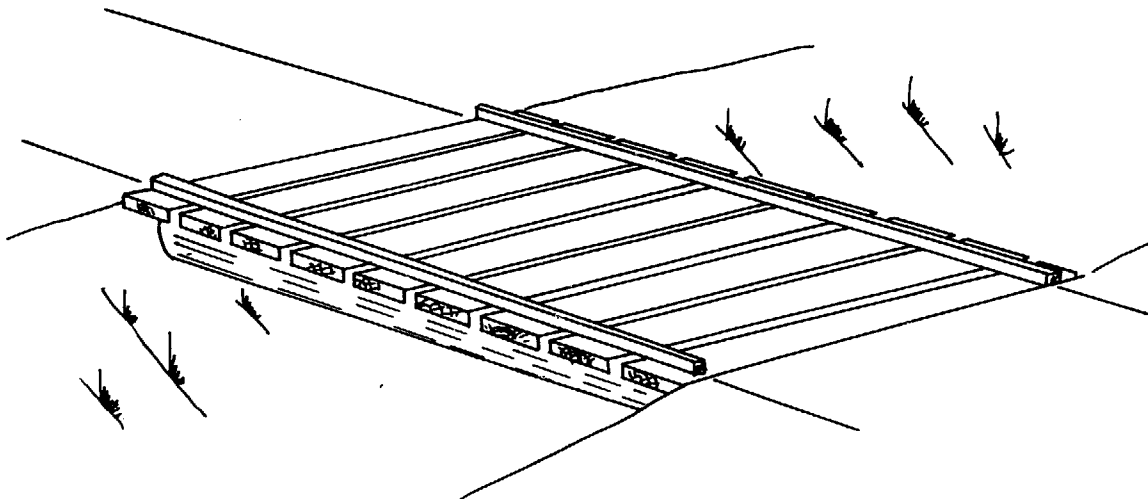

This kerbing is good for 2 reasons. For one reason, it is a safety kerb; it helps trucks not to fall off the bridge into the water. For another reason, the front wheels of trucks cannot shove the decking forward, the way a bulldozer shoves logs forward.

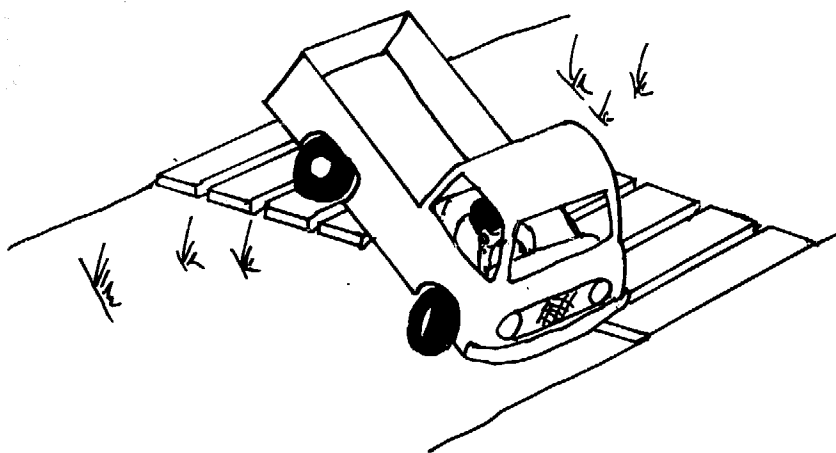

Picture showing truck falling off the bridge.

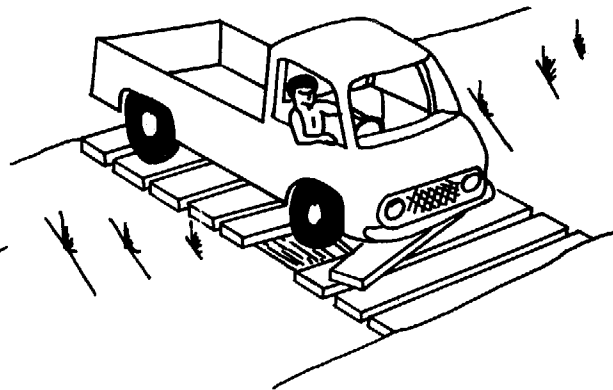

Picture showing truck shoving the decking forward.

10. Guide Posts:

Last, you must put in guide posts. The guide posts should be made of logs about 150 mm. in diameter. You must paint them white. You must not attach them to the bridge or the abutments. You must put one at each corner of the bridge. You must put them firmly in the ground behind the abutments and hard against the outside stringers. Do not forget to put up guide posts. They are important. They are most important where the road coming onto the bridge is not very good.

11. General information about (constructing and maintaining) log bridges:

You must not leave any holes on the bridge or any place where water can collect. If water collects in a hole, it will rot the timber quickly. You must paint the end of each log with a lot of creosote or coal tar or sump oil, and you must make a point at the end of any log that stands up.

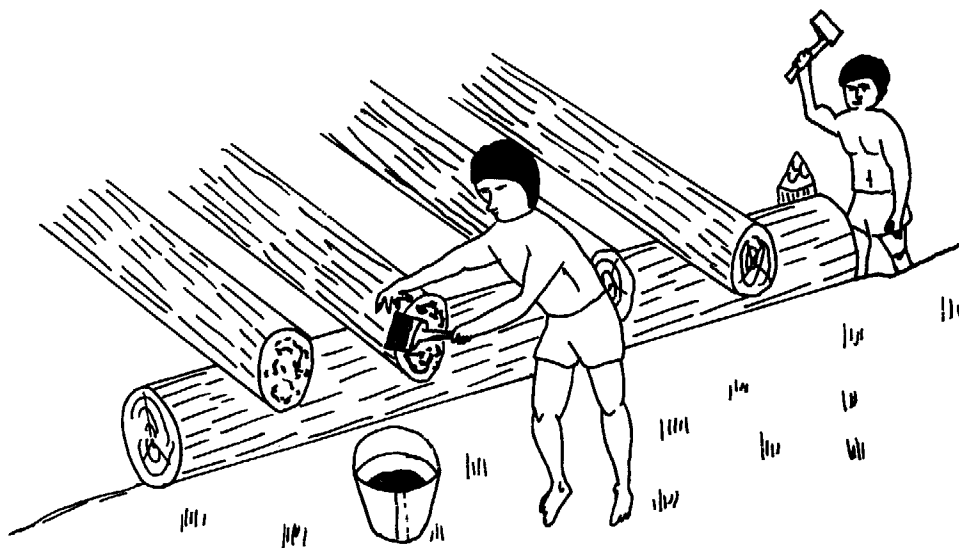

You must fill all holes that are made where bolt-heads are counter sunk. Fill these holes with caulking compound or something like that.

How to maintain the bridge: You must often look around the abutments to see if there is any erosion. The first time you must look for erosion is straight after the first flood. Suppose you find serious erosion and you think it might make the bridge fall down. You must ask the Local Government Supervisor about it. He will tell you what to do. You must clear away weeds and grass that grow on the abutments. Do not let weeds grow. The abutments must keep dry.

Clear away rubbish that collects around abutments. Rubbish might cause trouble in a flood.

Also, do not let dirt cover the decking of the bridge. Dirt holds water and water rots the timber quickly.

How to check the stringers: You must look at the stringer for rot. The first time you look at the stringers for rot is 3 years after the bridge was built.

The second time is 6 months after that and then every 6 months. You can hit the stringer with an axe. If it does not sound clear, get a brace and bit and bore a hole to see how deep the rot goes. This picture shows a stringer with good timber and some rot.

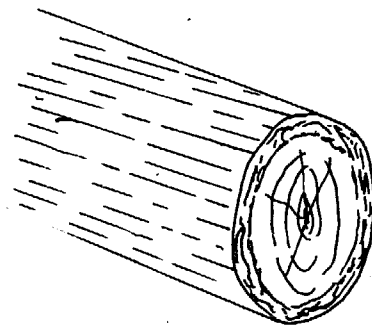

The stringer had to be 600mm in diameter for this bridge. It still looks like 600mm in diameter. But the good timber is only 480mm in diameter.

As soon as the diameter of the good timber is 25mm. less than the minimum diameter, you need for the bridge, you must put up a notice. You must stop heavy trucks from using the bridge, and you must start to get ready to replace the bridge.

## 12. Summary

Now I will list the most important things I have told you about constructing log bridges.

- (a) First, you must select good timber. The timber must not be rotten. You must read the table about diameter of timber and width of the bridge (page 105). The diameter of the timber must be at least as big as the table says.
- (b) Second, you must construct strong, stable abutments.

3. Fords:

You can build a simple and inexpensive crossing called a ford if the cost of a bridge is more than the Council has money for. A ford is a place where trucks can safely cross a river and the wheels of the truck run on the bed of the river.

Normally a river bed may look like this in cross section.

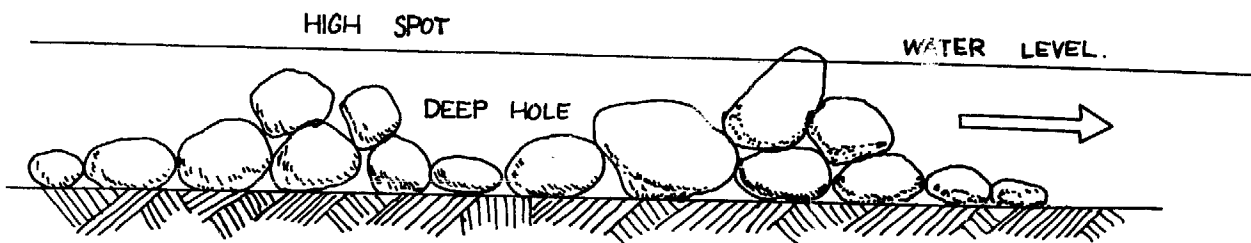

You can see rocks sticking up out of the water and other places are deep holes you cannot see from above. This is bad for trucks trying to cross. To make a better ford you install a round tube of wire screen filled with rock like this. It is held in place by a steel wire.

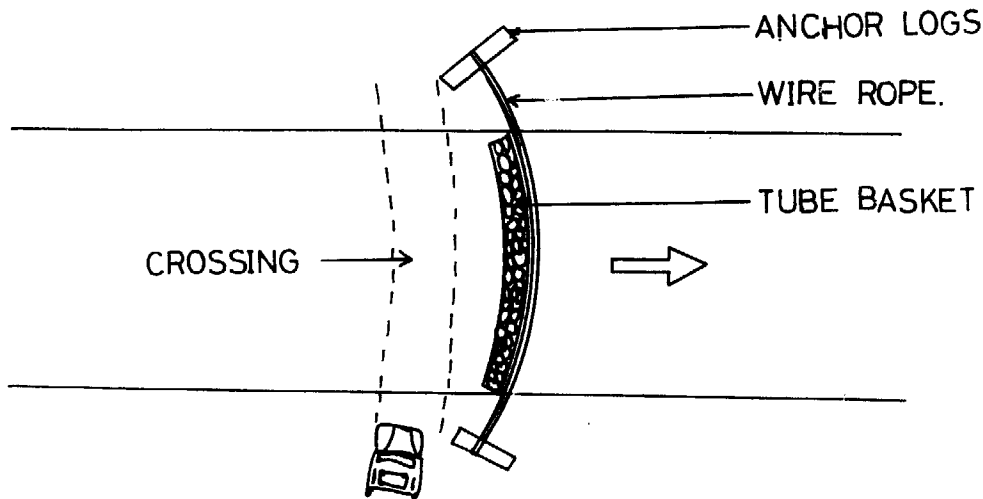

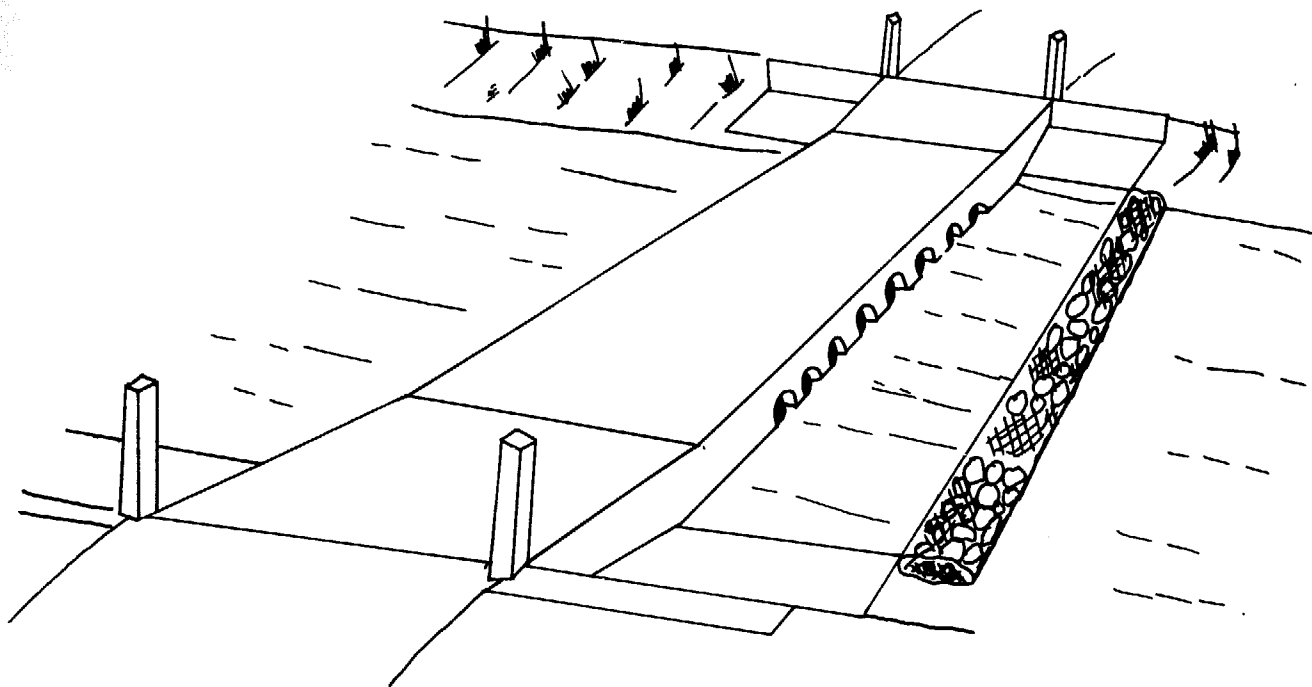

1. What is a good place for a low level crossing?

- (a) Suppose you want to build a bridge over a river or like this:  
The river bed is firm and does not change much, and is made of sand and gravel.
- (b) The river is usually not more than 0.5 m. deep during the dry season.
- (c) The river may be up to 2.0 m. deep during the wet season.
- (d) This flow of 2.0 m. deep is only for a little time after heavy rain and then the river quickly goes down and is not so deep.
- (e) Big logs and rocks do not come down the river.

All right, suppose your river or creek is like that. Then you can construct a low level crossing.

2. What materials do you need for a low level crossing?

You may need gabion baskets. A gabion basket is 2 m. x 1 m. x 1 m. in size and is made of wire mesh.

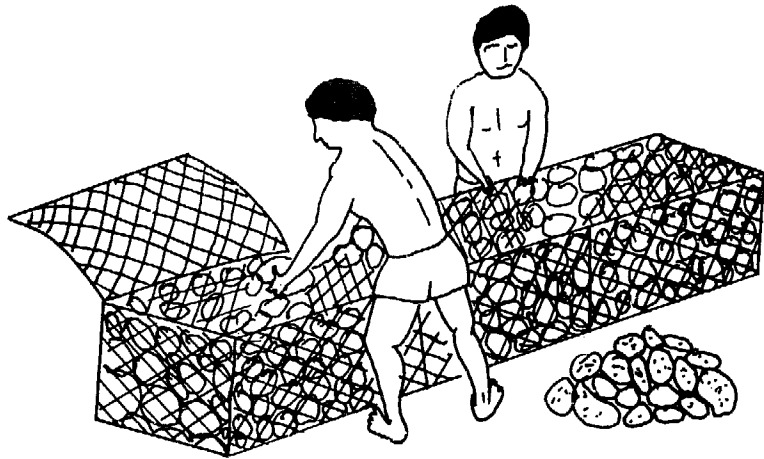

You may need a gabion or "Reno mattress". A reno mattress is 6 m. x 2 m. x 0.29 m. in size and is also made of wire mesh.

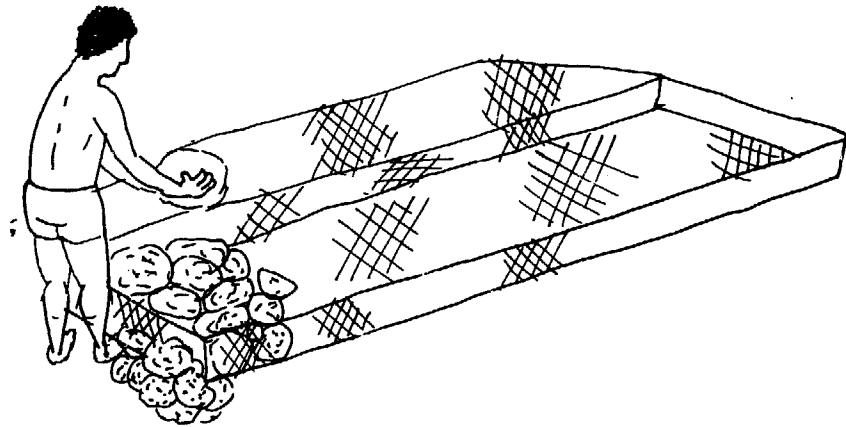

You fill these wire baskets with stones. The stones must be at least 100 m. in diameter. you need a gravel pit or river gravel close to the place for the crossing. You must fill between the baskets. The fill must be good sand mixed with clay or gravel mixed with clay. The fill must not have any dirt or leaves or sticks of wood. It is easy to construct a low level crossing.

You must take care that the crossing goes right across the part of the river where the water flows. Do not leave bare ends to get washed away. You must ask the Local Government Engineer to send a surveyor or an engineer to select a good place for the crossing. He will draw a plan, and make an estimate of cost. Then you must get the funds ready and buy the baskets and mattress and take them to the place.



(c) You must not let any of the timber in the bridge or the abutments get wet. You must leave on the bark if you can. You must paint the timber with creosote, coal tar or sump oil before you build the bridge. Suppose you must take off the bark, then you must cover the timber with malthoid (flooring that has tar in it). You must fill all bolt-holes with caulking compound or something like that. You must paint logs that stand up straight.

(d) A log bridge cannot take the same load after it is 3 years old. Suppose you build a bridge the way I have told you, the bridge will take a weight of 10 tonnes. A tractor weighs about 2 tonnes. A tractor and trailer with a load of wet dirt weighs about 6 tonnes. A "5 yard truck" with a load of dirt weighs about 10 tonnes. But after 3 years, the stringers and abutments will start to rot. The bridge cannot take such a big load after 3 years, and you are going to have to start thinking about replacing this bridge with a new timber bridge or a permanent materials bridge.

Multi-span bridges:

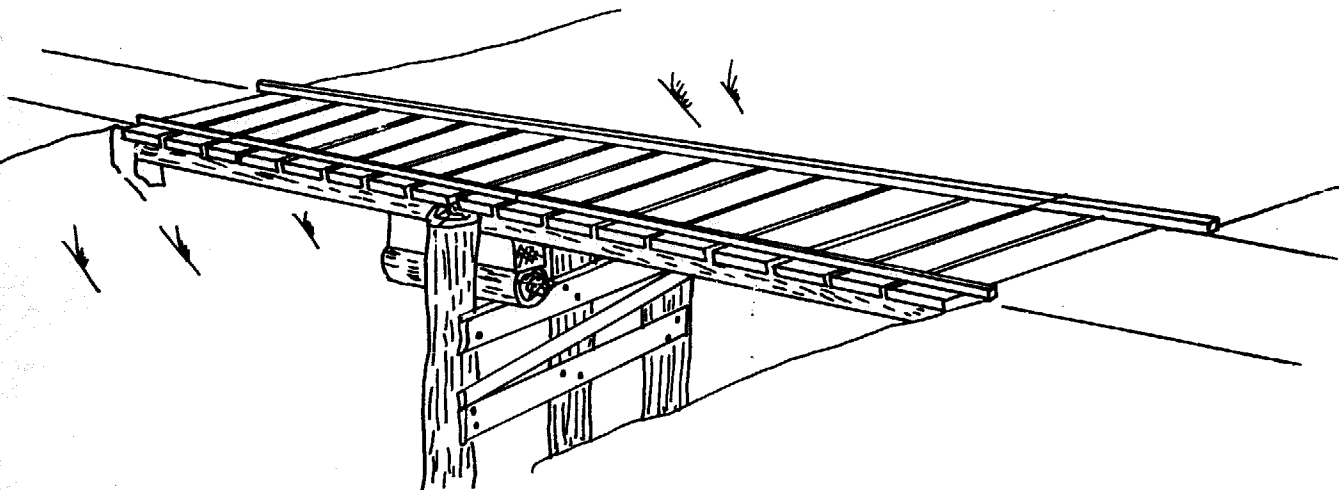

Suppose you cannot get logs stringers that have a big diameter. You can write to the Local Government Engineer. He will help you. His engineers will design a multi-span bridge for you. Do not try to do it yourself.

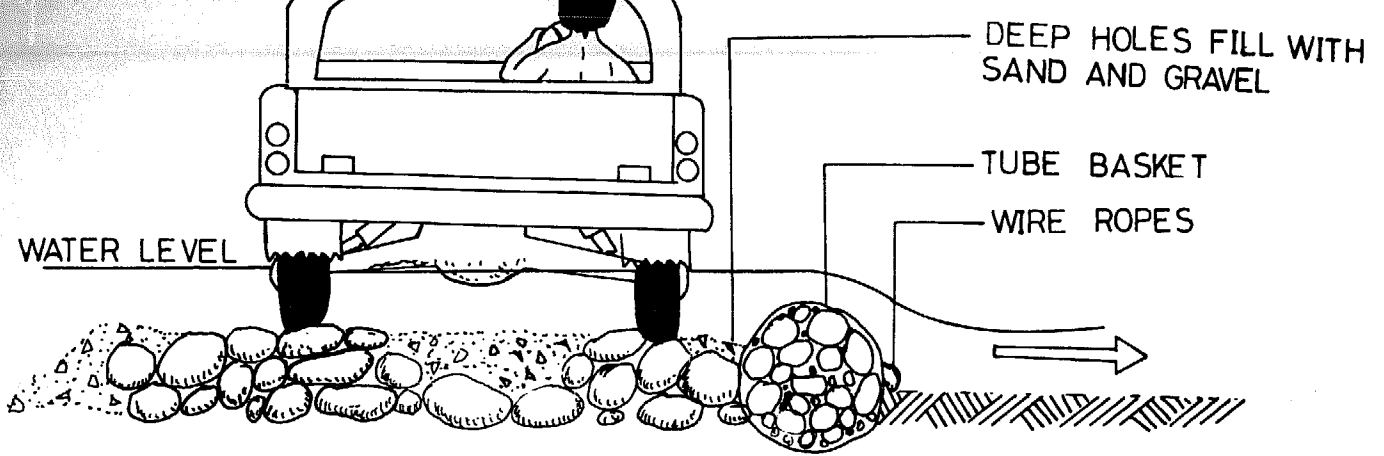

The truck now runs on a layer of sand and gravel bought from up stream by the river but prevented from going further by the presence of the tube basket.

A strong wire rope anchored to a log or concrete block at each bank holds the tube basket in place.

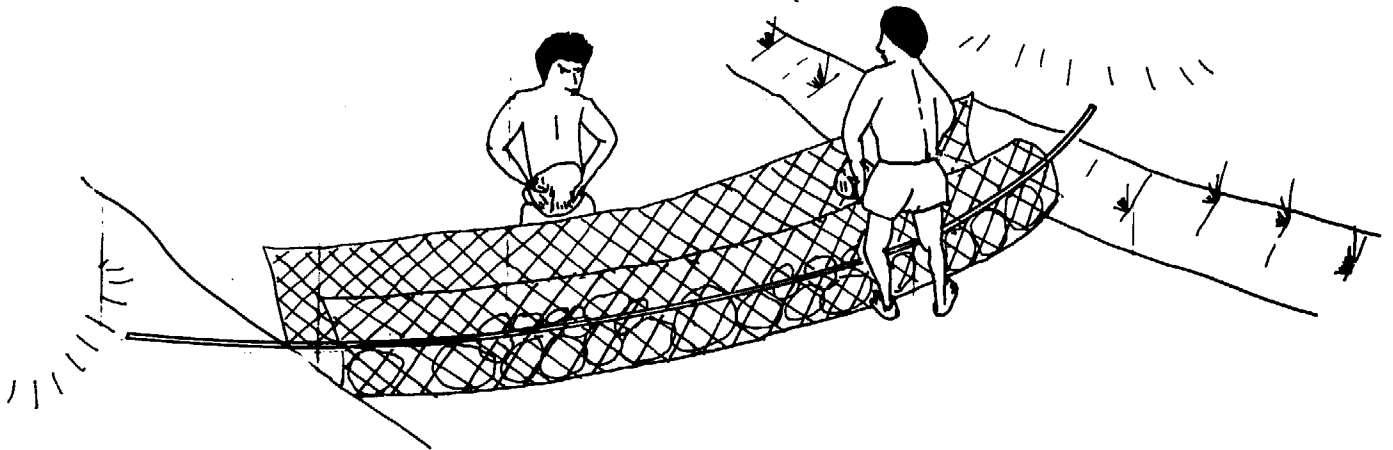

The tube basket can be easily made from a roll of fencing mesh laid out flat on the bed of the creek or river and filled with rock. While filling is going on the outside edge is raised and bent over to form a tube like this. Tie the basket shut at the top. With binding wire 2 or 3 mm thick. Finally attach the steel wire rope.

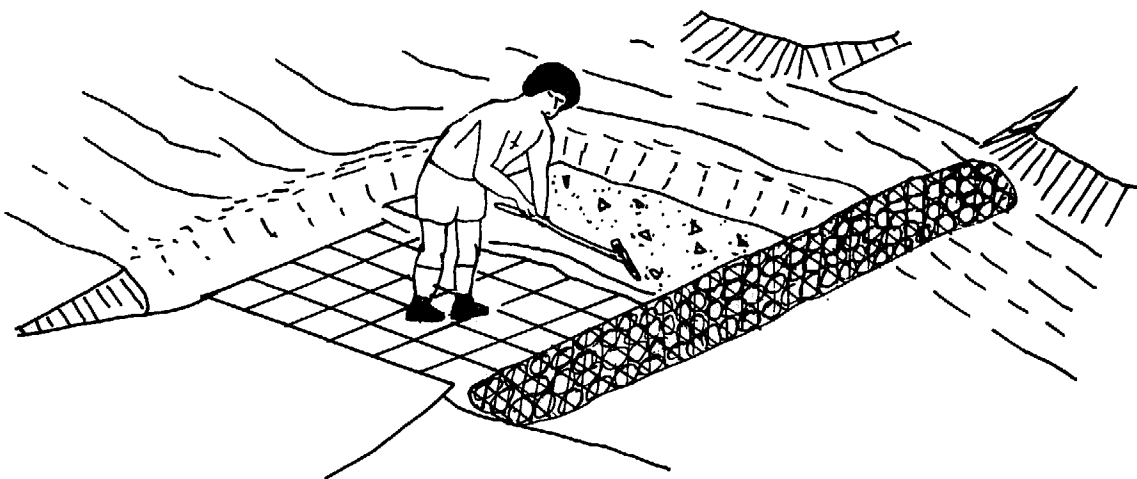

4. Causeways:

A causeway is a series of culvert pipes placed on top of a concrete slab and covered by a concrete deck. If it is built in the proper place it will let the normal river flow pass through the pipes. Flood water will pass over the top and not damage the causeway.

During flooding, the trucks must wait at the side of the road until the water level drops.

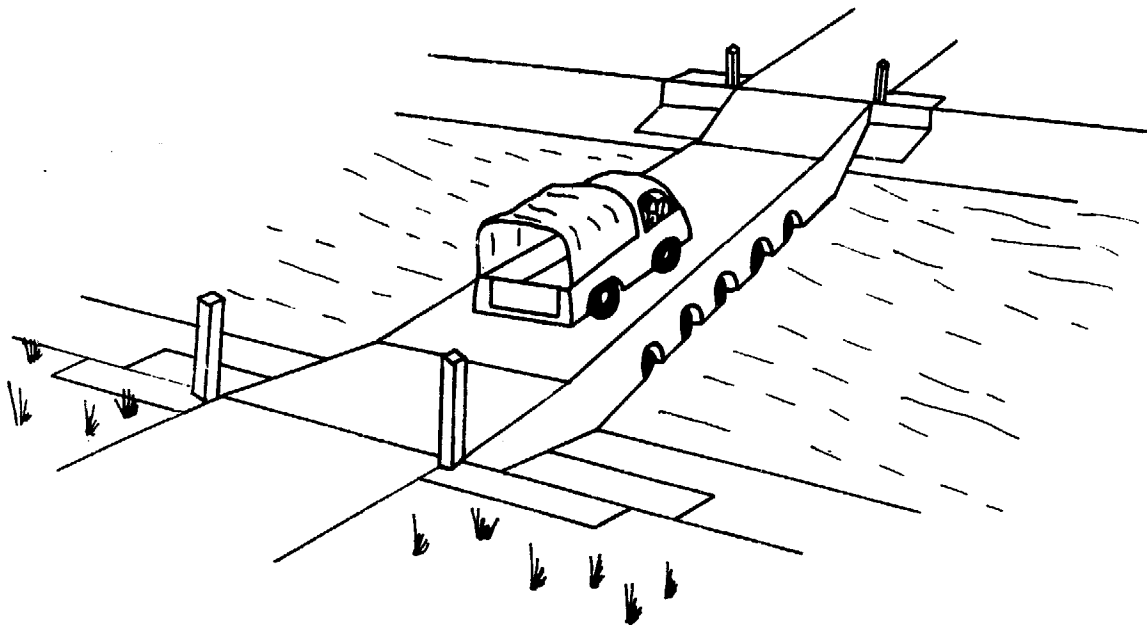

A causeway during normal river flow.

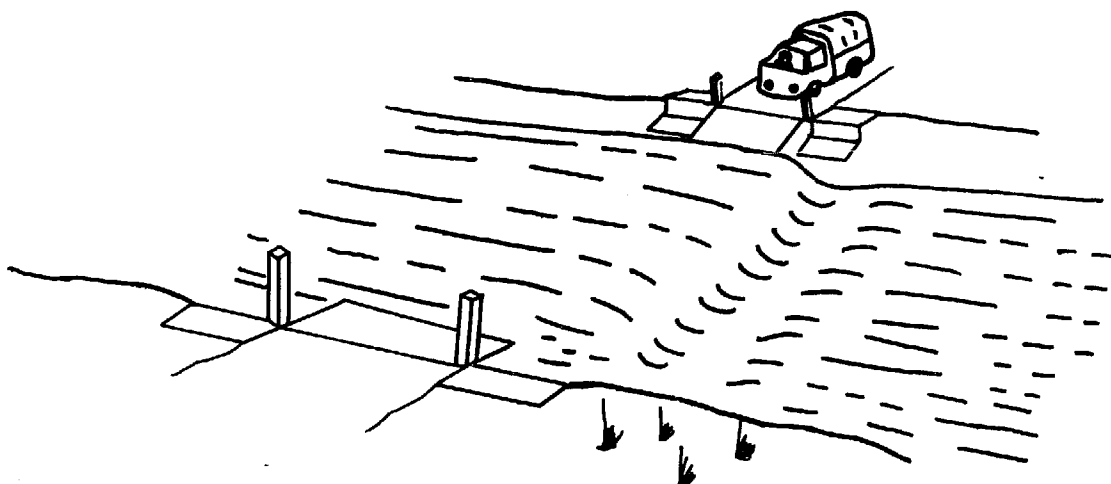

A causeway during flood flow times.

Pipes in a causeway are either corrugated steel or concrete. A design must always be obtained from the Local Government Engineer for there are many places where the causeway will not work properly. For example the water may be moving too quickly or the normal water depth may be too great.

5. Girder Bridges:

This bridge has three steel beams between the abutments, with timber planks on top. The beams are supplied in pieces not more than 6 metres long, and they are bolted together on the job. The span is not more than 15 metres. The bridge can carry loads up to 15 tonnes.

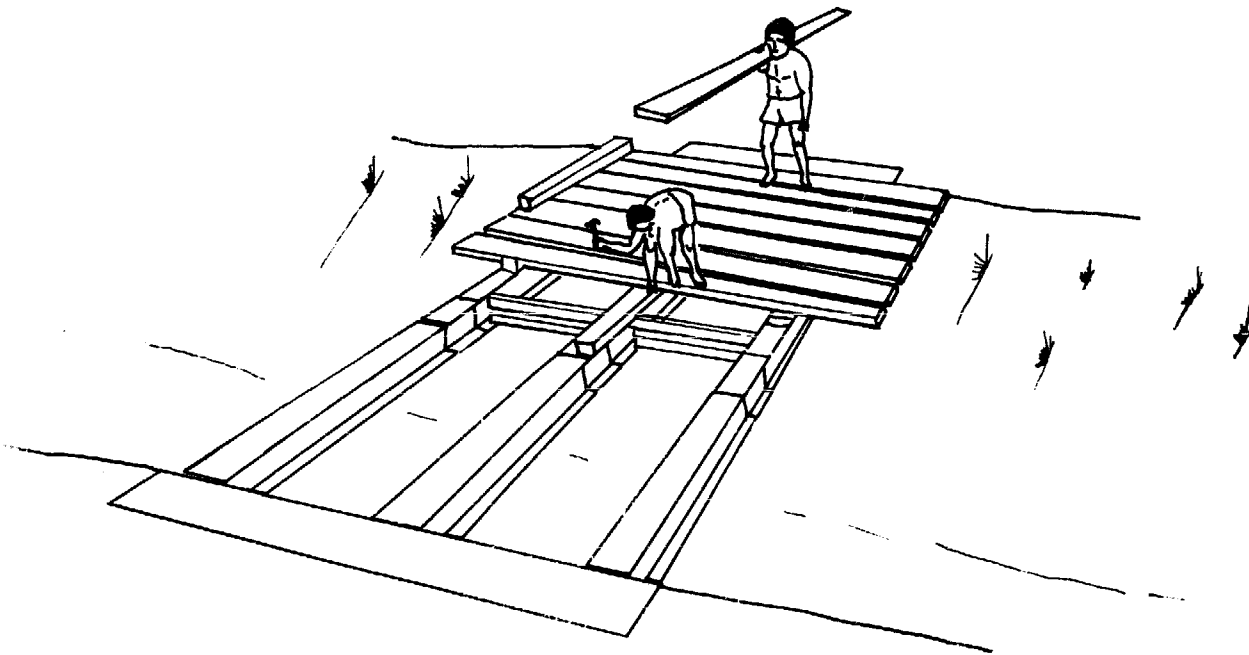

6. Expanded, or lattice girder bridges:

These bridges are like the steel beam ones. One thing is different. The beams are made bigger by being cut in two, spread apart, then joined by steel angles. The span is 18 to 27 metres and they have a timber deck. The load is 10 to 15 tonnes. The engineers drawing will show what load you are allowed to put on the bridge.

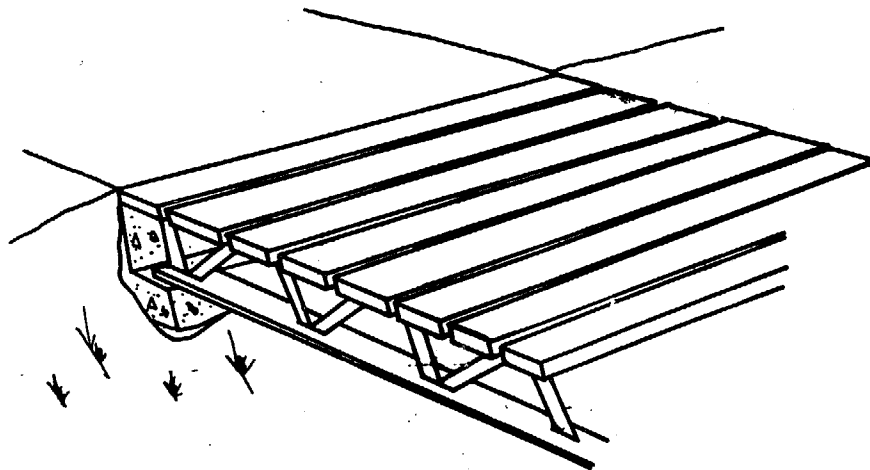

7. Bailey Bridges:

These bridges are made of panels bought from England, with other steel parts. Each panel is 3 metres long. They are joined together on the site. They can be built any length up to about 45 metres. But if they are more than 30 metres, they get heavy and expensive. They have timber decks. They can take loads from 5 to 20 tonnes, depending on the length, and the type of construction used.

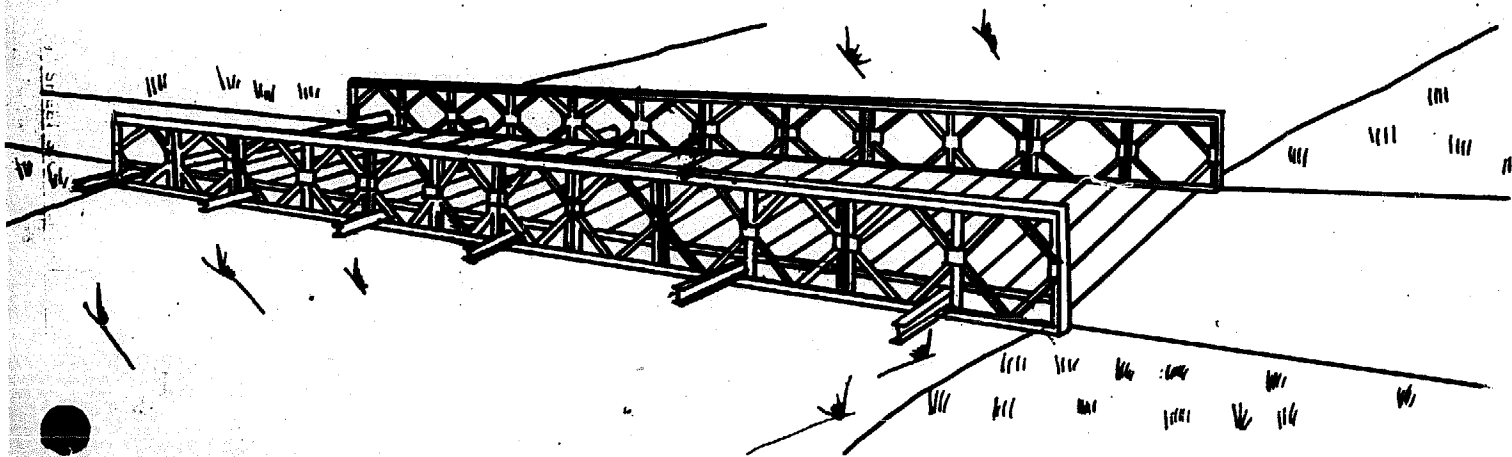

### 8. Suspension Bridges:

These bridges are hung steel ropes, or cables, which are strung between towers and tied to heavy "anchors blocks" in the ground. The load is 10 tonnes. They can be used for long spans, up to 75 metres.

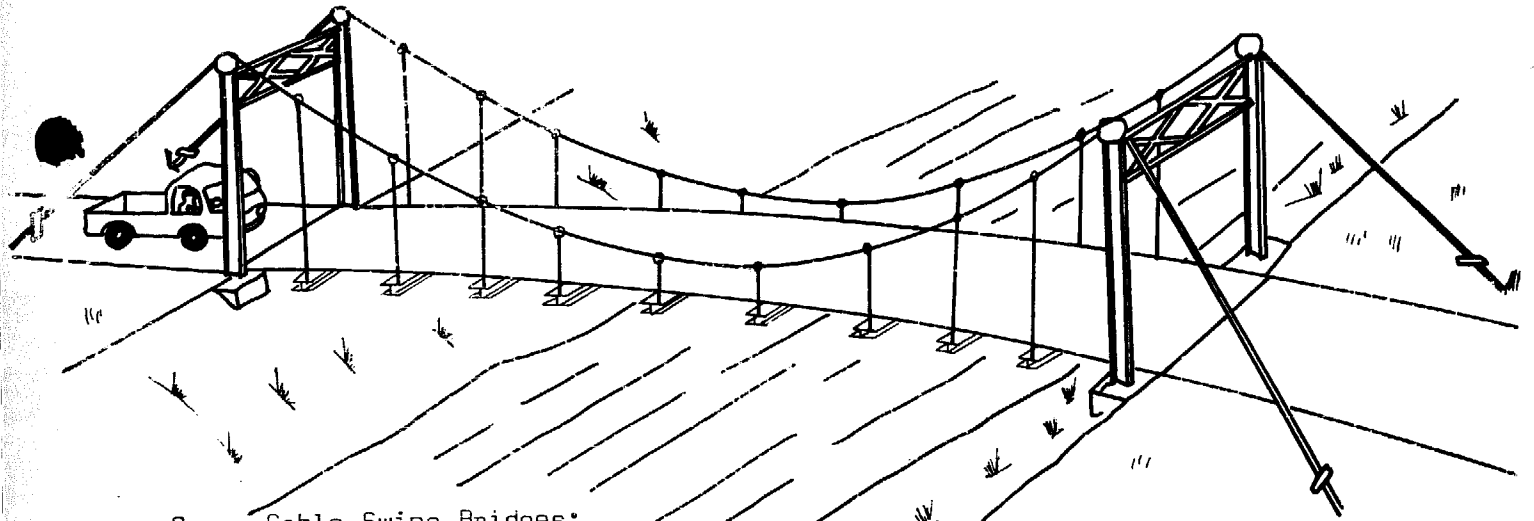

### 9. Cable Swing Bridges:

These bridges are made of a deck laid straight on a row of wire cables. They are quite cheap, and it is easy to get the materials for them into the Highlands in planes. They cannot take more than about  $6\frac{1}{2}$  tonnes load. They can span about 45 metres.

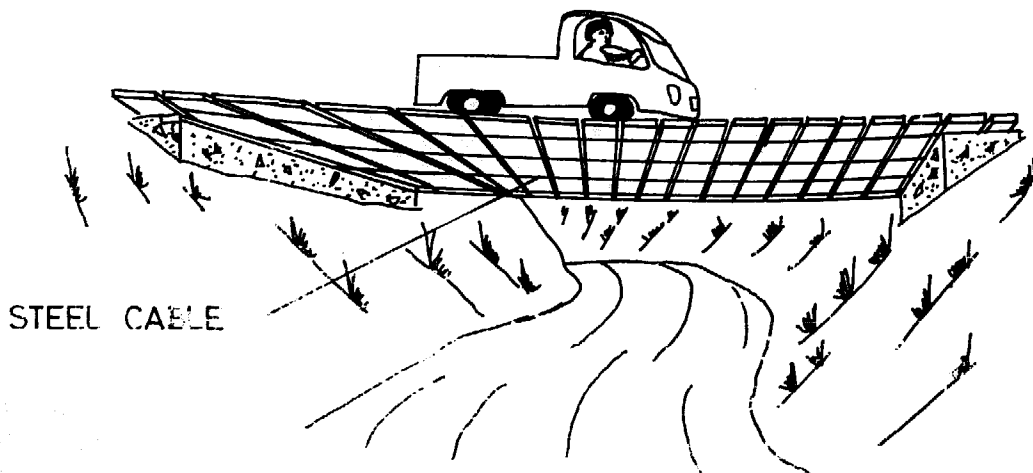

GENERAL NOTESNEED FOR SURVEY AND DESIGN

Suppose you want to make a river crossing out of permanent materials. First the road must be surveyed. Then the road must be upgraded where it needs upgrading. Then you construct the crossing to go in a place that helps the road.

BUT suppose you want a crossing for a big river. You must get the Local Government Engineer to help you. Big rivers are not easy to bridge. The Engineer will find a good place for a crossing. Then he says where the road will go to lead to the site of the river crossing.

This is important. Why?

It is important because when you have a bridge, the road near it should be good. This should be done at the time the bridge is built. It might be too hard, to fix the road up later on, or it might be impossible to fix it, if the bridge is in a bad place. Wherever you can use culverts, it is better to have culverts instead of bridges. Culverts are stronger than bridges; they are also cheaper and they need less maintenance. Often you can get a better horizontal line using culverts, then you can with bridges.

Bridges, as well as causeways, should be designed by men from the Office of the Local Government Engineer at Public Works Department Headquarters, Boroko. Engineers come and measure the place on the river, draw plans and tell how much it should cost to build a bridge. Councils do not have to pay for this. It is help given by the Government. Even log bridges may be built with concrete abutments, and it is a good idea to have these abutments designed by engineers. Then, you can build permanent bridges on them a few years later when the Council has more money.