

MISCELLANEOUS EXAMPLES OF FORGED
WORK IN DIFFERENT STAGES. PLATE 46

SPLIT COTTERS

PLATE 46 illustrates several ways of making split cotters.

FIG. 1 shows a split cotter.

FIG. 2 shows a square bar cut through, and flattened down as in FIG. 3; next form the head as shown in FIG. 4, then finish to size, and cut off.

Another method is by pointing the end of the bar and flattening it, as shown in FIGS. 5 and 6, then doubling it as in FIG. 7, and shaping it as in FIG. 8. Next cut it off the round bar.

A third method is by using a flat bar which has been reduced, as shown in FIG. 9. Cut it along the dotted line and place the pieces ready to weld, as shown in FIG. 10.

SPLIT COTTERS. PLATE 46

FIG 1

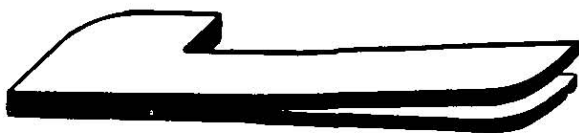

FIG 2



FIG 3

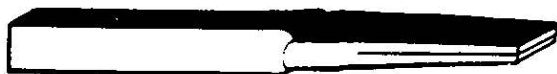

FIG 4



FIG 5



FIG 6



FIG 7



FIG 8



FIG 9

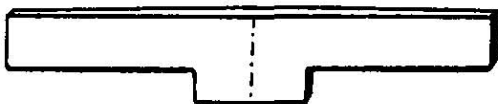

FIG 10



MISCELLANEOUS EXAMPLES OF FORGED
WORK IN DIFFERENT STAGES. PLATE 47

BOLTS

PLATE 47: FIG. 1 illustrates a bolt, the other FIGS. showing how it is made.

FIG. 2 shows the fullering of a hexagon bar with necking fullers. The bar is then drawn down to size, again use necking fullers, this time to round off the corners. Cut it off the bar, as in FIG. 3.

FIG. 4 shows a method of squaring the head of the bolt by placing it in a hand bolster. FIG. 5 shows the head of the bolt being corrected in an anvil swage.

FIG. 6 shows a small pin bolt, which can be made in FIG. 7, bolster if a round body is required, and in FIG. 8, bolster if a square body is required.

FIG. 9 shows a round bar in a bolster, having enough material to form the head by hammering it to fit the recess in the bolster.

BOLTS.

PLATE 47

FIG 1



FIG 2



FIG 3

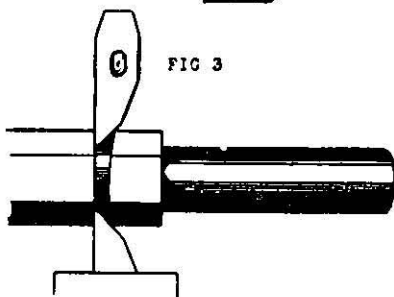

FIG 4

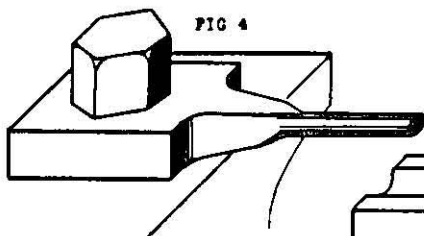

FIG 5

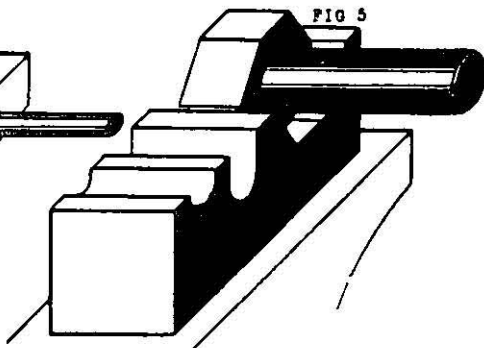

FIG 6

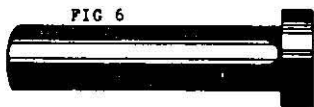

FIG 7

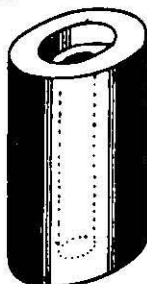

FIG 8

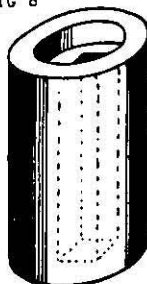
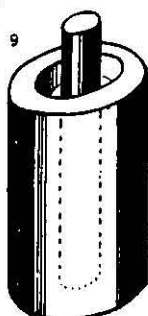

FIG 9



MISCELLANEOUS EXAMPLES OF FORGED
WORK IN DIFFERENT STAGES. PLATE 48

WRENCH

PLATE 48: FIG. 1 illustrates a wrench to fit a 4-inch square nut, and made from a 2-inch by $\frac{1}{2}$ -inch bar.

First operation, FIG. 2: Point the ends of a 2-inch by $\frac{1}{2}$ -inch bar, 32 ins. long as shown.

Second operation, FIG. 3: Double over the ends as shown, making the bend 4 ins. from each end.

Third operation, FIG. 4: Bend the double ends over as shown.

Fourth operation, FIG. 5: Weld the double ends as shown, leaving the length A-B 16 ins.

Fifth operation, FIG. 6: Fuller as shown, making each division 4 ins.

Sixth operation, FIG. 7: Bend the bar as shown.

Seventh operation: Weld the two ends together, then complete by welding a 1-inch diameter bar to it.

WRENCH.

PLATE 48

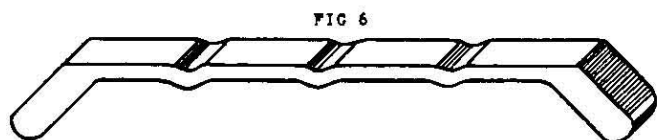
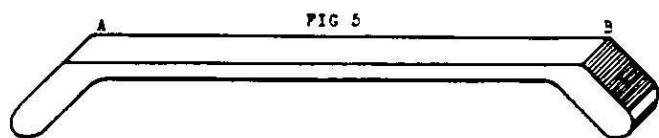
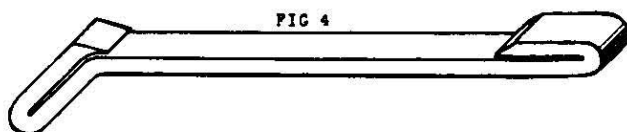
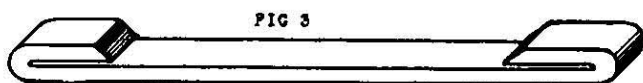
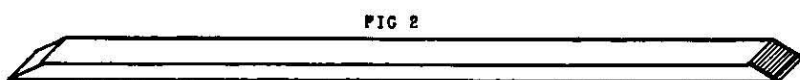
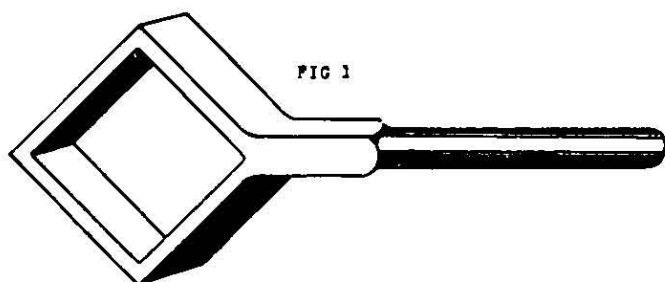
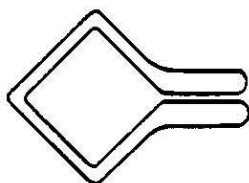

FIG 7



MISCELLANEOUS EXAMPLES OF FORGED
WORK IN DIFFERENT STAGES. PLATE 49

BRAKE GUIDE

PLATE 49: FIG. 1 illustrates a brake guide, made from a 2-inch by $\frac{1}{2}$ -inch bar.

First operation, FIG. 2: Bend, then weld as shown at A, leaving enough material to complete the other necessary operations.

Second operation, FIG. 3: Bend the bar at B, after finishing off A.

Third operation, FIG. 4: Bend the other end of the bar at C.

Fourth operation, FIG. 5: Bend at D.

Fifth operation, FIG. 6: Fuller at E as shown, then bend at E, making D-C at right angles to the bottom line. Weld together, as shown in FIG. 1.

FIG. 7 illustrates a method of bending a bar by fullering, as first operation.

BRAKE GUIDE.

PLATE 49

FIG 1



FIG 2

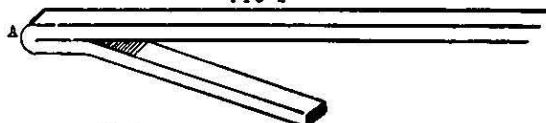

FIG 3

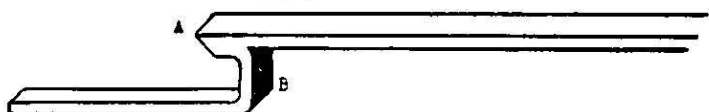

FIG 4

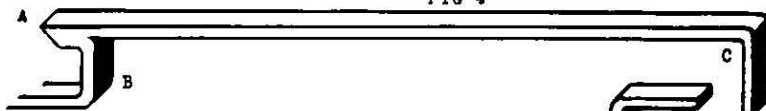

FIG 5

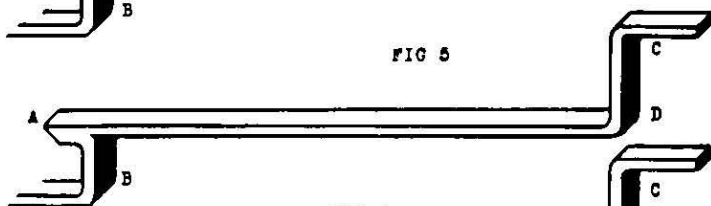

FIG 6

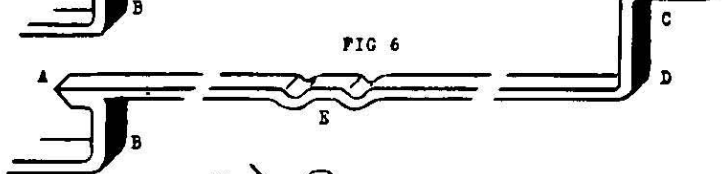
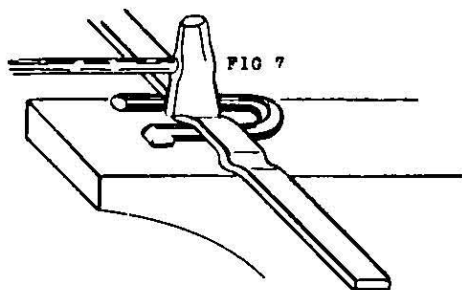

FIG 7



MISCELLANEOUS EXAMPLES OF FORGED
WORK IN DIFFERENT STAGES. PLATE 50

HOOKS

PLATE 50 : FIG. 1 illustrates a hook.

First operation, FIG. 2 : In a flat bar make a hollow space. This is done by using a round-faced fuller, often called a bob-punch.

Second operation, FIG. 3 : Take a round bar, jump the end, and weld it into the space previously prepared. Immediately turn it over, place in a bolster (FIG. 4) and hammer to complete the welding.

FIGS. 5 to 8 illustrate another method by which this hook can be made. Punch a hole through the bar, as shown in FIG. 5. FIG. 6 shows a pin placed through the hole and riveted to the bar. FIG. 7 shows the shape of the pin which is used. Raise the bar and pin to a welding heat, then place in a bolster to complete the welding, as shown in FIG. 8.

FIG. 9 shows the bar fullered ready to draw down to the required size.

Another method of making hooks is to make them from a solid bar. Draw down, as shown in FIG. 10, leaving enough material to form the pin.

HOOKS.

PLATE 50

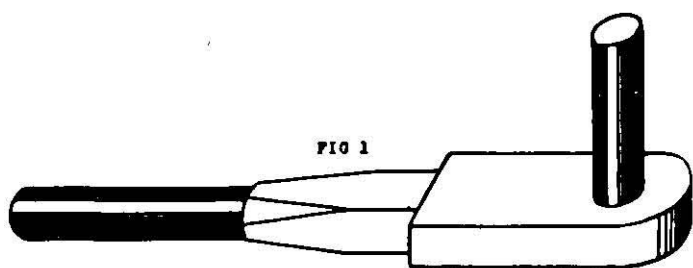

FIG 1

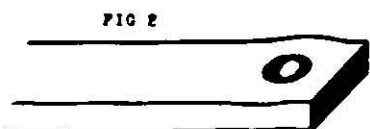

FIG 2

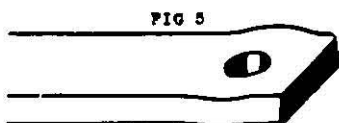

FIG 5

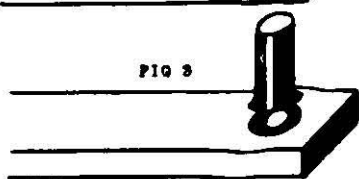

FIG 3

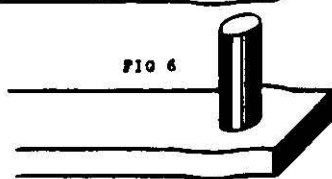

FIG 6

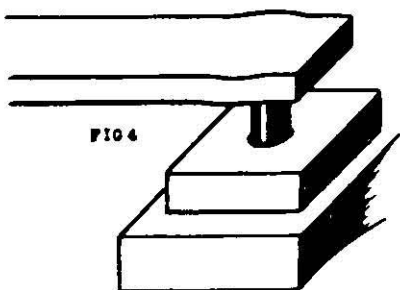

FIG 4

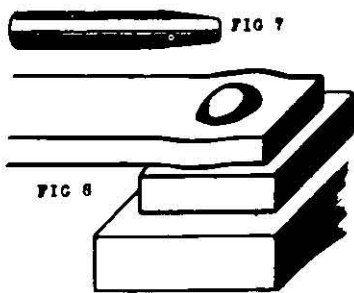

FIG 8



FIG 7

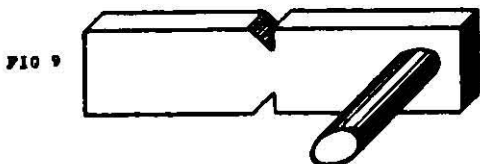

FIG 9

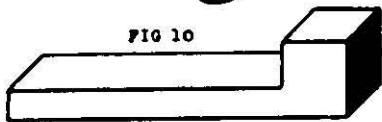

FIG 10

MISCELLANEOUS EXAMPLES OF FORGED
WORK IN DIFFERENT STAGES. PLATE 51

DOUBLE EYE

PLATE 51: FIG. 1 illustrates a double eye. The most satisfactory way to make this forging is as follows :—

First operation, FIG. 2 : Make a recess in the centre of the bar as shown.

Second operation, FIG. 3 : Place a bar to fit the recess to prevent it from altering when the bar is being fullered or side setted as shown.

Third operation, FIG. 4 : Draw down the ends as shown, and cut through the dotted lines to round off the inside corners, then bend the ends as in FIG. 1. Finish off by placing on a mandril, as shown in FIG. 5.

DOUBLE EYE.

PLATE 51

FIG 1

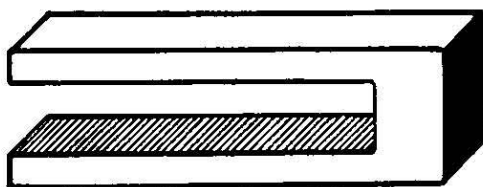

FIG 2

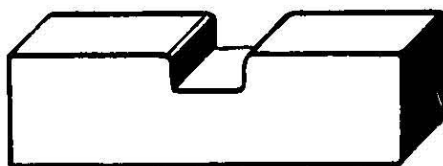

FIG 3

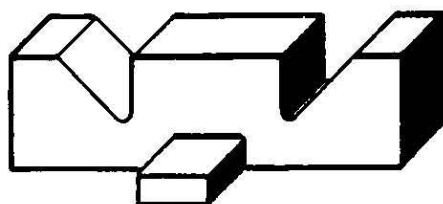

FIG 4

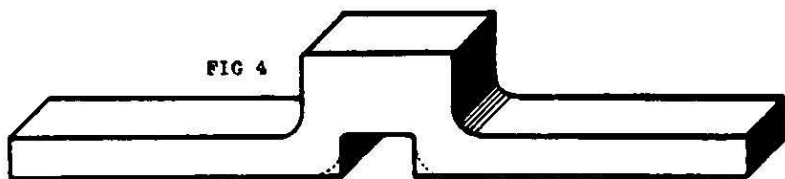
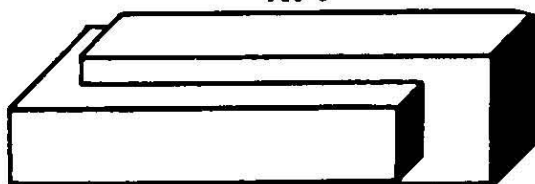

FIG 5



MISCELLANEOUS EXAMPLES OF FORGED
WORK IN DIFFERENT STAGES. PLATE 52

LIMBER DOUBLE EYE

PLATE 52: FIG. 1 illustrates a limber double eye and V-piece, made from a $3\frac{1}{2}$ -inch by $1\frac{1}{2}$ -inch bar.

First operation, FIG. 2 : Draw down 4 ins. of the $3\frac{1}{2}$ -inch by $1\frac{1}{2}$ -inch bar to $1\frac{1}{2}$ in. square as shown.

Second operation, FIG. 3 : Swage the $1\frac{1}{2}$ -inch square to $1\frac{1}{2}$ in. diameter as shown, leaving enough $1\frac{1}{2}$ in. square to form the double eye.

Third operation, FIG. 4 : Flatten the $1\frac{1}{2}$ in. diameter as shown, and roughly shape the double eye.

Fourth operation, FIG. 5 : Stamp the double eye as shown.

Fifth operation, FIG. 6 : Punch a hole as shown.

Sixth operation, FIG. 7 : Cut open from the end to the hole on a shallow swage ; this prevents the eye from going out of shape as shown.

Seventh operation, FIG. 8 : Finish off the double eye by placing a mandril in between, and hammer down under the steam hammer to the required size.

Eighth operation, FIG. 9 : Start the opposite end, punch a hole in as shown, then open it out.

Ninth operation, FIGS. 10 to 11 : Draw down each end to size, under the steam hammer.

LIMBER DOUBLE EYE.

PLATE 52

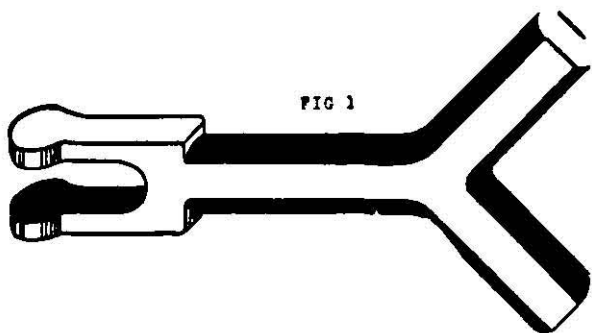

FIG 1

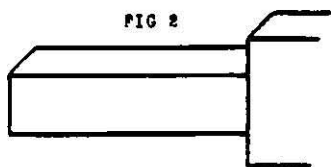

FIG 2

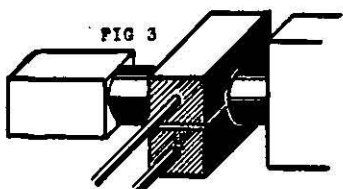

FIG 3

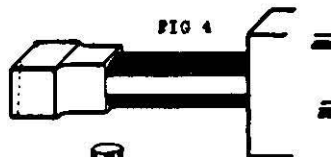

FIG 4

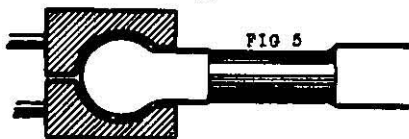

FIG 5

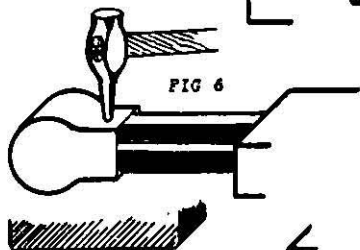

FIG 6

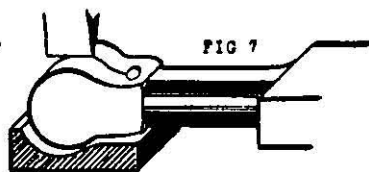

FIG 7

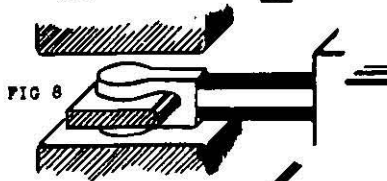

FIG 8



FIG 9

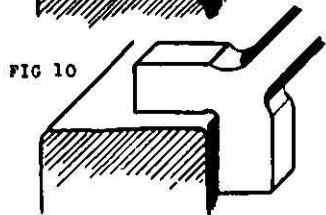

FIG 10

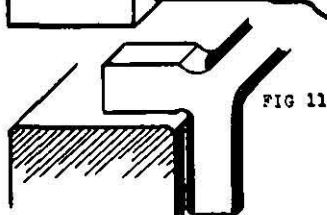

FIG 11

MISCELLANEOUS EXAMPLES OF FORGED
WORK IN DIFFERENT STAGES. PLATE 53

LEVER DOUBLE EYE

PLATE 53: FIG. 1 illustrates a lever double eye, made from a 5-inch by 2-inch bar. An easy method of making this is given in the following illustrations:—

First operation, FIG. 2: Side set the bar as shown, leaving enough material in the centre to make the shank and boss, as shown in FIG. 1.

Second operation, FIG. 3: Draw down each side to the thickness of the bosses, then fuller or side set as shown.

Third operation, FIG. 4: Draw down in between the bosses, and fuller the inside corners (A) as shown. This prevents the chisel marking the drawn-out parts when shaping the bosses by cutting along the dotted lines.

Fourth operation, FIG. 5: Bend to shape, then fuller as shown, leaving enough material to form the end boss.

Fifth operation, FIG. 6: Draw down, using two narrow blocks as shown, then shape the boss as in FIG. 4.

LEVER DOUBLE EYE.

PLATE 53

FIG 1

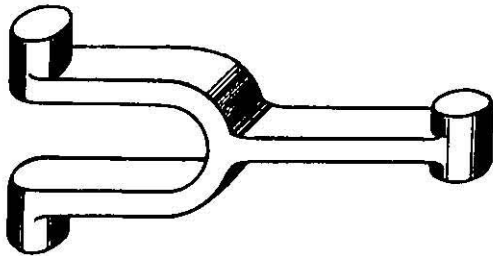

FIG 2



FIG 3

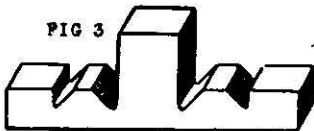

FIG 4

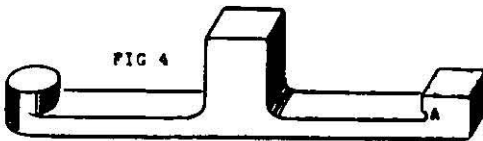

FIG 5

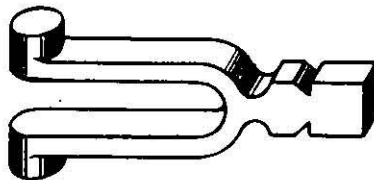
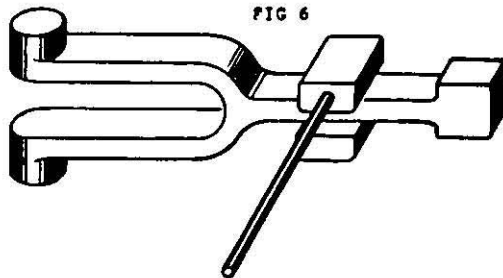

FIG 6



MISCELLANEOUS EXAMPLES OF FORGED
WORK IN DIFFERENT STAGES. PLATE 54

LEVER ARM

PLATE 54: FIG. 1 illustrates a lever arm, made from 3 ins. square.

First operation, FIG. 2 : side set the bar as shown.

Second operation, FIG. 3 : Draw down to the size of the double eye, then fuller as shown.

Third operation, FIG. 4 : Draw down as shown, then cut from the bar.

Fourth operation, FIG. 5 : Bend it, thus making it easier to draw out the pin. (Which is the fifth operation, FIG. 6.)

Sixth operation, FIG. 7 : Straighten it, then place the pin into a bolster and hammer it level, as shown. Next shape the end, as seen in FIG. 1.

Seventh operation, FIG. 8 : Punch a hole and split open, as shown.

Eighth operation, FIG. 9 : Place a mandril in between, and hammer down to shape as shown. Finish off by rounding the end.

LEVER ARM.

PLATE 54

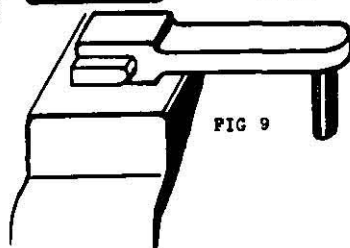
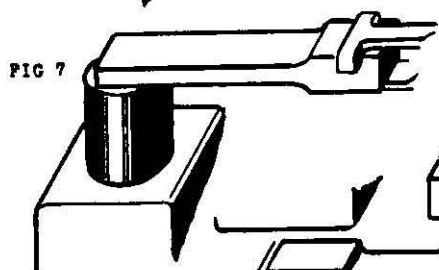
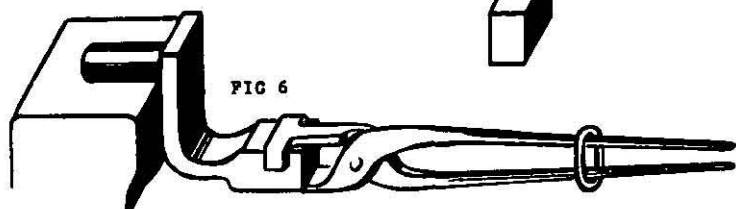
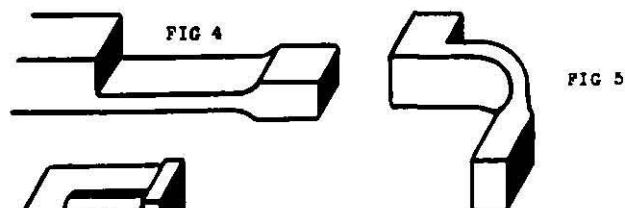
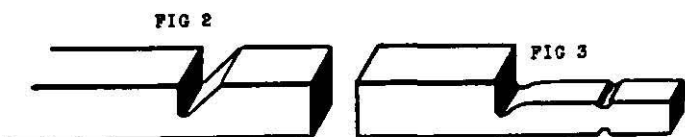
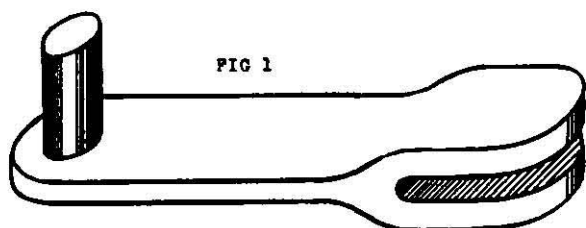

MISCELLANEOUS EXAMPLES OF FORGED
WORK IN DIFFERENT STAGES. PLATE 55

LEVER

PLATE 55: FIG. 1 illustrates a lever, made from a 2-inch diameter bar.

First operation, FIG. 2: Punch a hole 4 ins. from the end, and cut it open as shown.

Second operation, FIG. 3: Set back the ends, then cut off the bar at the dotted line as shown.

Third operation, FIG. 4: Square each end as shown.

Fourth operation, FIG. 5: Fuller close into the neck as shown.

Fifth operation, FIG. 6: Draw down to 1 in. diameter, then draw down the opposite end, and complete by bending one end, as seen in FIG. 1.

The same lever can be made out of a square bar. Instead of punching a hole, and splitting as in FIG. 2, side set the bar, as shown in FIG. 7, and draw the ends down, then adopt the same operations as previously shown.

Another method of making a similar lever is to form it out of a square bar as follows: first form the boss with the radius fullers, as shown in FIG. 9, and then adopt the same methods that have been shown.

LEVER.

PLATE 55

