

**CONNECTING ROD**

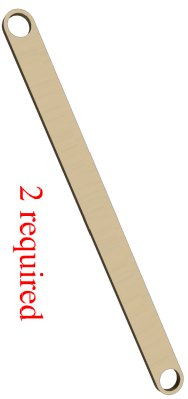

2 required

**CONROD BUSH**

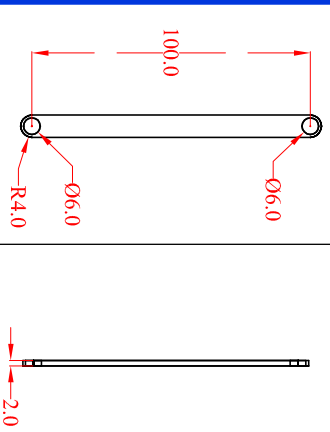
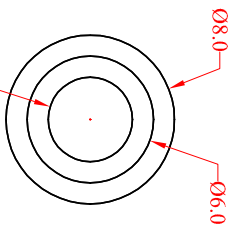
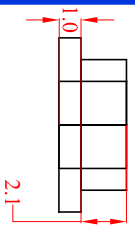

4 required.

**ECCENTRIC STRAPS**

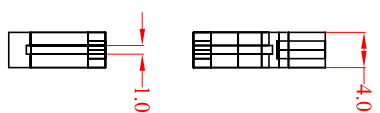
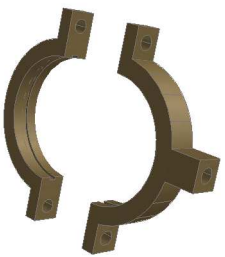
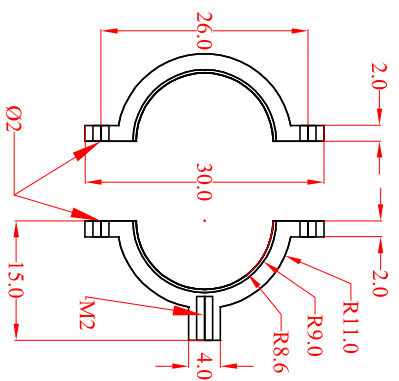

**ECCENTRIC ARM LINK**

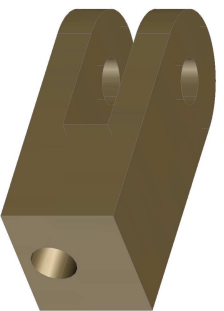
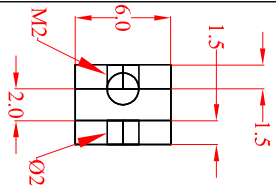
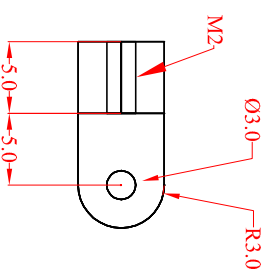

**ECCENTRIC ROD LINK**

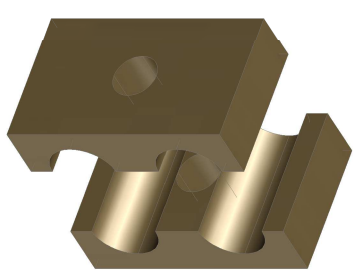
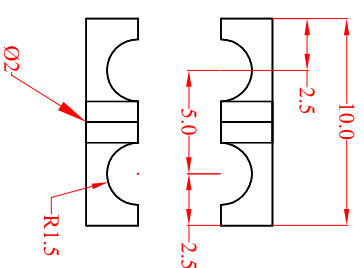
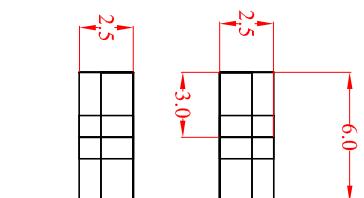

**ECCENTRIC RODS**

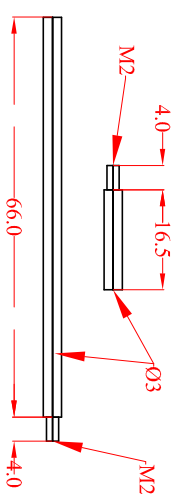

**BOLT, NUT, SLEEVE & WASHER STYLES**

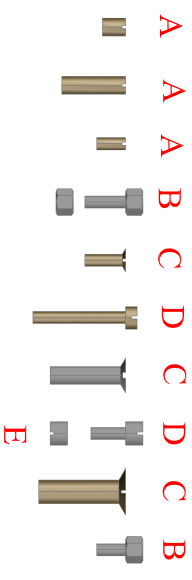

See Design Notes.xlsx for table of required nuts, bolts and washers.

**ECCENTRIC ROD ASSY**

