

PARTS LIST			
ITEM	QTY	PART NUMBER	DESCRIPTION
1	1	Valve	MATERIAL: 360 BRASS
2	1	Valve Tappet	MATERIAL: 360 BRASS

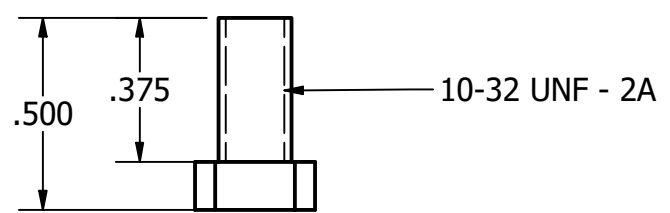

Valve Tappet

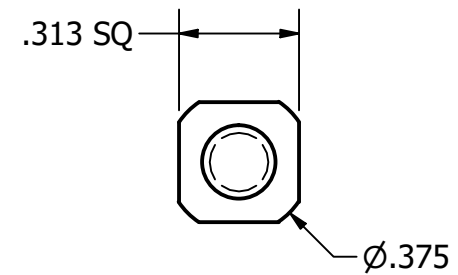
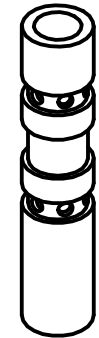
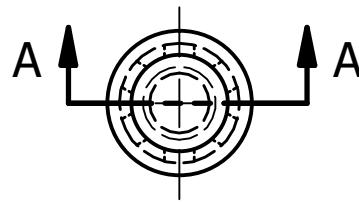
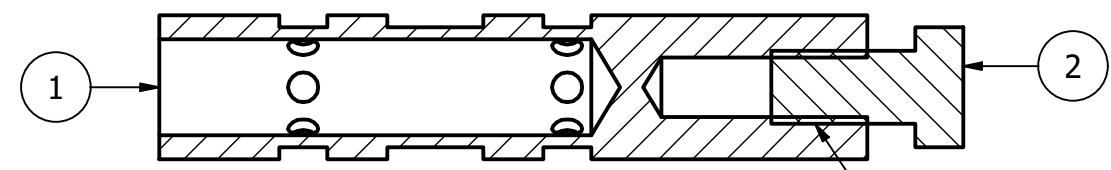
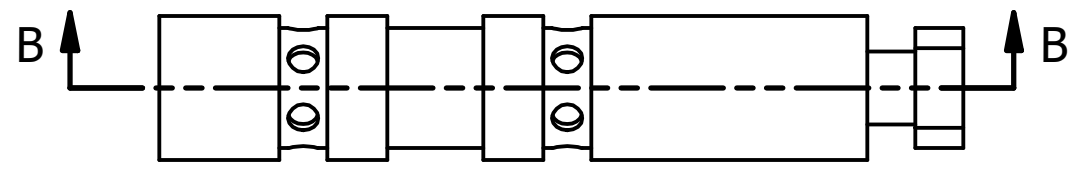

SECTION B-B

ADJUST VALVE LASH AS REQUIRED.  
 SECEURE THREAD WITH LOCITITE, TREAD TAPE, WHATEVER WORKS...

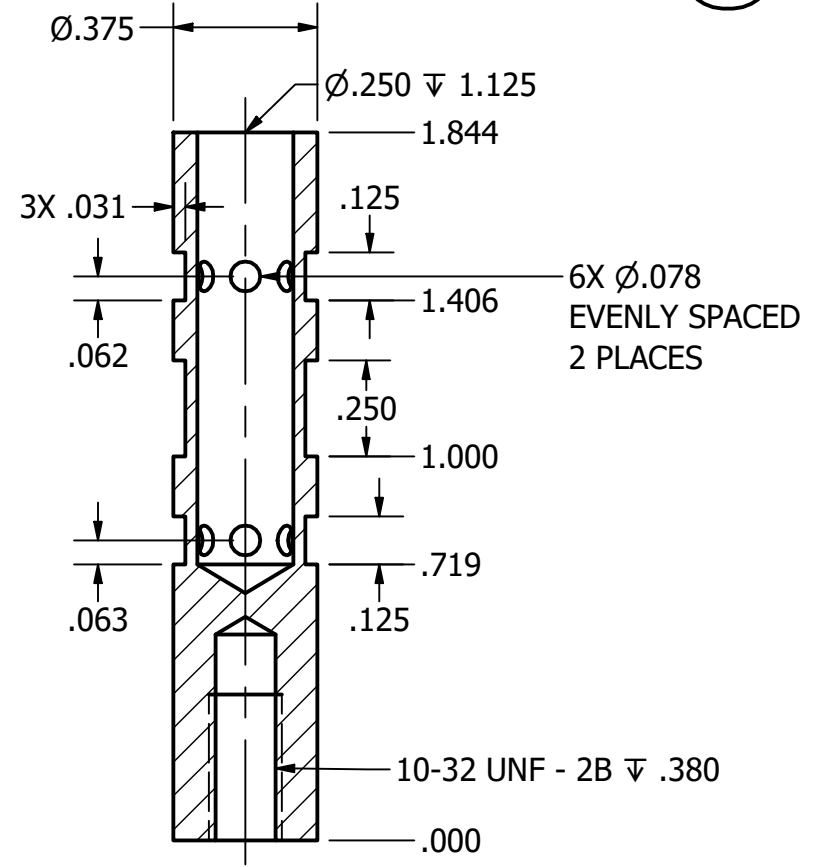

SECTION A-A  
 Valve

DRAWN Rob	4/3/2022	Chirico Engine Works		
CHECKED		TITLE		
QA		ASSY - STEAM VALVE		
MFG		SIZE B	DWG NO Assy - Valve	REV
APPROVED		SCALE	SHEET 1 OF 1	