



ROUTERLATHE



trend[®]
routing technology

Dear Customer

Thank you for purchasing the Trend Routerlathe. We hope you enjoy many years of creative and productive use of this product.

Trend welcomes comments on this and all our products in our aim to develop and improve what we do to meet the needs of you, the customer.

Please contact our Technical Support Department in the first instance if you have any comments or queries.

Trend is the UK's leading supplier of router cutters, equipment and accessories.

Our Craft Range of Cutters referred to in this manual, is designed specifically to meet the needs of amateur craftsmen and woodworking enthusiasts in quality and value.

For the professional woodworker, the Trend Professional Range of Routing Products has become the industry's standard guide to the most comprehensive range of router cutters and related products available in the UK.

Please contact your nearest Trend stockist to obtain any of our products and for a copy of the latest Trend Routing Catalogue.

Please remember to return your guarantee card within 14 days of purchase.



Please read the operating instructions carefully and keep them together with your jig.

Please note that dimensions are approximate.

Contents

| | |
|---------------------------------------------|----------|
| Introduction | 2 |
| – Tools Required | 2 |
| – Specification | 2 |
| Items Enclosed | 3 |
| Safety Precautions | 4 |
| – Cutter Care | 4 |
| – Useful Advice | 4 |
| Assembly & Description of Parts | 5 |
| Operation | |
| – Mounting the Workpiece in the Routerlathe | 8 |
| – Setting the Height of the Cutter | 9 |
| – Wood Preparation | 10-11 |
| – Rounding-up the Workpiece | 12 |
| Applications | |
| – Circular Beads and Coves | 13 |
| – Roping and Spiralling | 14-15 |
| – Through Spirals | 16-17 |
| – Straight Beads and Flutes cut lengthwise | 18-19 |
| – Contour Turning | 20-21 |
| – Tapered Turning | 22-23 |
| Examples | |
| – Turnings | 24-25 |
| Spare Parts | |
| – Spare Parts List | 26-27 |
| – Spare Parts Diagrams | 28-IB |

Intended Use

The unit is intended for stationary operation of routers.

The following symbols are used throughout this manual:



IMPORTANT!

Denotes risk of personal injury, loss of life or damage to the tool in case of non-observance of the instructions in this manual.



IMPORTANT!

Denotes risk of electric shock.



If you require further technical information or spare parts, please call our technical support department on 0044 (0) 1923 224681.

INTRODUCTION

The Routerlathe has been designed to enable you to utilise your router to the fullest - making table legs, turnings, posts, spindles and other turned carvings of almost any design you wish. There are five basic operations as well as rounding-up which can be performed on your Routerlathe. They are:-

1. Turning circular beads and coves



2. Roping or spiralling, both right and left hand

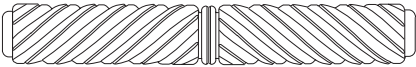

3. Straight beads and flutes cut lengthwise



4. Contour turning with a template

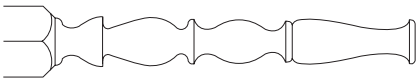

5. Tapered turning



The five basic type cuts enable you to produce many different designs by using them in combination. See pages 24 and 25 for drawings of typical turnings.



IMPORTANT!
The Routerlathe is designed for the leisure craftsman and not for production use in a commercial environment.

Tools Required

A set of spanners and a screwdriver are required for the initial assembly of the Routerlathe. Additional screws or nuts/bolts will be required for mounting the user-made Routerlathe workboard to a suitable surface.

Spanners 8mm, 10mm and 11mm

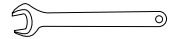

Screwdriver with flat head



Specification:

Maximum material length – 930mm
 Maximum length for spirals – 630mm
 One spindle rotation – 175mm linear movement
 Timber square section – Min. 26mm Max. 79mm

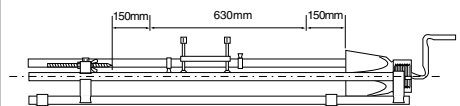

ITEMS ENCLOSED

1 x Routerlathe Assembly Complete

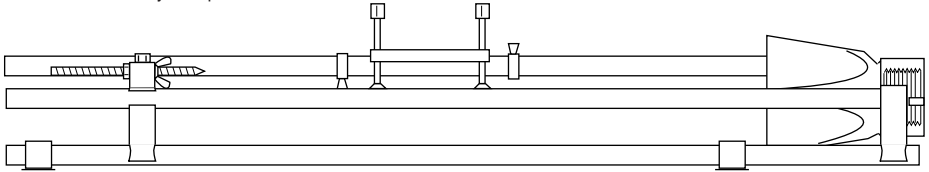

1 x Hex Key 5/32" A/F

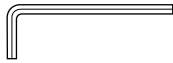

1 x Handle

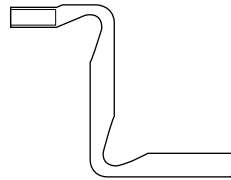

4 x Tube Clamps

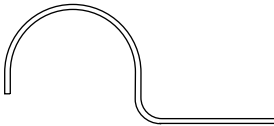

1 x Manual



1 x Guarantee Card



4 x Mounting Bolt Sets



2 x Router Fixing Bolts

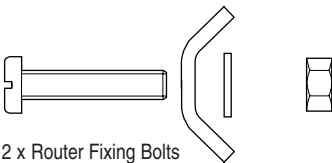

1 x Template Follower Set

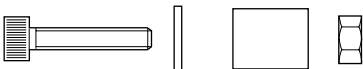

2 x Template Mounting Set



Optional Accessory for the Routerlathe

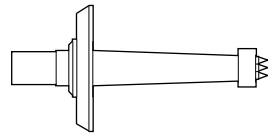

RL/DC Routerlathe Drive Centre

The drive centre is an accessory which enables contour turning and fluting over the full length of the workpiece. Square, round and shaped workpieces can be mounted quickly and securely. It can be used for spiral work, but will now allow spirals to be turned right to the end of the component. The drive centre is fitted into the position of the standard drive spindle.

SAFETY PRECAUTIONS

- Always switch off the power and unplug the router when changing cutters or when making adjustments.
- Always wear protective goggles when routing.
- Wear sound protective ear muffs when routing for long periods of time.
- Always wear a dust mask. Use dust extraction equipment whenever possible.
- Do not wear loose clothing. Make sure baggy sleeves are rolled up and ties are removed.
- Always remove spanners and hex keys from the workpiece before switching router on.
- Keep hands well clear of the router cutter when routing.
- Avoid accidental starting of the router. Make sure the power switch is in the 'Off' position before plugging in and connecting to the electrical supply.
- Never leave the router unattended when running. Always wait until the router comes to a complete stop before making any adjustments.
- Do not switch the router on with the cutter touching the workpiece.
- Mount the Routerlathe securely to a work bench or to a workboard fitted to a suitable surface.
- Periodically check all nuts and bolts to make sure they are tight and secure.

Cutter Care

- Do not drop cutters or knock them against hard objects.
- Cutters should be kept clean. Resin build-up should be removed at regular intervals with Resin Cleaner[®]. The use of a dry lubricant will act as a preventative such as Trendicote[®] PTFE spray.
- Cutter shanks should be inserted into the collet at least 3/4 of shank length to prevent distortion. A distorted collet should be discarded, as it can cause vibration and damage the shank.

- Do not overtighten collet as this will score the shank and create a weakness there.
- It is also advisable to periodically check the router collet nut for wear.

Useful Advice

- Judge your feed rate by the sound of the motor. In time, the operator will acquire a 'feel' for the router, and a feed speed relative to the work will come naturally. Too slow a feed will result in burning.
- Apply the normal precautions as with any electric power tool.
- The main abuse of routing machines is the inclination for operators to overload them. The motto is 'Keep the revs up'. The drop in revolutions should not exceed, if possible, more than 20% of full running speed.
- The motor of a router is susceptible to the accumulation of sawdust and wood chips, and should be blown out, or 'vacuumed', frequently to prevent interference with normal motor ventilation.
- Refer to the Instruction Manual supplied with your router for full details of its features and safety information.
- The use of a fine height adjuster is highly recommended (if available for your router) for accurately adjusting the height of the cutter when routing.
- Trial cuts should be made on waste material before starting any project.



IMPORTANT!

If using Resin Buster[®] to clean the frame tubes, please ensure it is removed immediately after it has loosened the resin, as it may lift the chrome finish on the frame tubes.

ASSEMBLY AND DESCRIPTION OF PARTS

Routerlathe Main Assembly

This comprises of a headstock and a tailstock which are held in line with each other by four steel tubes. A carriage which carries the router travels along these tubes. The top two tubes should be sprayed regularly with a dry lubricant spray, such as Trendicote[®]. This will give a smoother sliding action when the router carriage is moved lengthways. Do not use oil or grease.



Headstock

This consists of a cast aluminium frame, a cable drum on which the steel cable is wound and which turns inside the headstock frame, a cast aluminium drive spindle which turns inside the cable drum, a locking plate which will lock the cable drum relative to the frame (this should be checked to be tight, i.e. locked, before commencing any work), and index pin which permits the indexing of the drive spindle relative to the cable drum. The drive spindle can be indexed in increments of 15° for equal spacing of 2, 3, 4, 6, 8, 12 and 24 cuts around the workpiece. A handle fits into the back of the drive spindle and is provided to rotate the workpiece. The drive spindle is designed to have considerable 'play' or looseness within the cable drum to allow for tapered turning.



Tailstock

The cast aluminium tailstock carries the tailstock centre screw which is a 1/2" threaded steel rod. The centre screw passes through a guide bushing which is adjustable up and down to permit turning straight or tapered workpieces. The tailstock can be positioned along the steel tubes to accommodate different lengths of workpiece.



Steel Cable

The steel case is wound around the cable drum and runs over Delrin[®] pulleys and is joined together with a tension spring which serves to keep the cable taut. There are two metal lugs which are attached to the cable - one on the upper and one on the lower cable lines. The lugs are for fixing the cable to the cable clamp to advance the router and router carriage when making 'roping' or 'spiralling' cuts (see page 14). The cable clamp is part of the carriage and has a recess to accommodate the lug. Attaching the upper cable lug to the cable clamp produces a left hand spiral, whereas attaching the lower lug to the cable clamp produces a right hand spiral. The lugs are left unattached when making other than spiral cuts.

Router Carriage

This has two feet with long threads. These can be adjusted to raise or lower the carriage relative to the workpiece in order to position the carriage as close as possible to the workpiece without touching it. **The use of a vertical fine height adjuster is recommended, if one is available for your router.** If one is not available, then the feet can be used to finely adjust the depth of cut (see page 9) and also to provide a repeatable 'stop' or maximum depth gauge. Slots are provided for numerous mounting options for routers.

Template Follower

This is used for template work and should be fitted to the router carriage. The tube should be fitted over the casting provided and the bolt and washer inserted and nut fitted. Use the hex key which is provided to tighten the bolt. The use and construction of templates is shown on page 20.

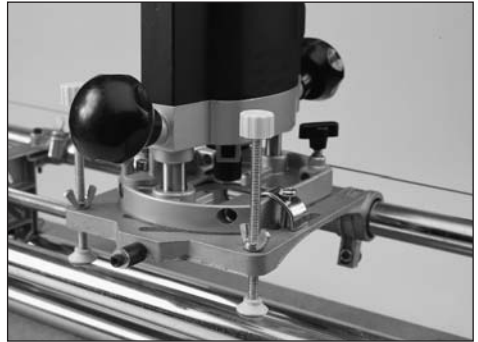

Mounting Tube Clamps and Bolts

These are provided for mounting the Routerlathe on a base board which can then be clamped to a workbench. Position tube clamps over tubes and mark the centres of the holes. Drill 6mm holes and fit the mounting bolt set.

The base board can be produced from any material that is sufficiently rigid. Medium Density Fibreboard 18mm thick is ideal. Typical dimensions of the base board would be 1200mm by 200mm.

Mounting the Router on the Router Carriage

The router carriage has several slots for attaching the router. Two router fixing bolts are provided for this purpose. If your router has a switch trigger in the handle, mount, if possible, so that the switch is on the headstock side. The spindle of the router should be central to the hole in the carriage. Choose this position in the slots for the router fixing bolts to give an even securing pressure on the router base.

Securing the Router to the Carriage

The plates should be engaged on the lip of the router sub-base and the nuts tightened securely with a 10mm spanner. Alternatively the router base can be bolted to the carriage by drilling two 6mm holes where appropriate and fitting two M6 nuts and bolts. This may not appeal to all users, but will give a more permanent mounting of the router. The router fixing bolts should be fitted first to hold router to the carriage securely whilst performing this drilling operation.

Carriage Stops

There are two carriage stops on the top tube which serve as stops for the carriage at each end of the desired cutting travel. The two stops can be positioned against each side of the carriage to prevent any lengthwise movement of the carriage. This is especially important when routing circular beads and coves.

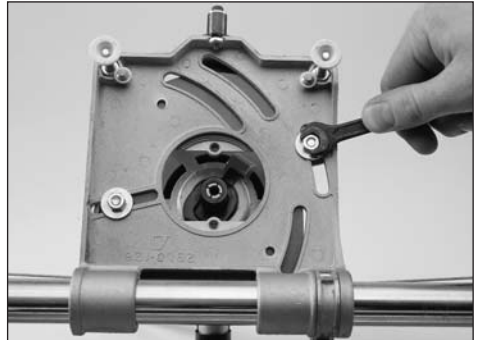
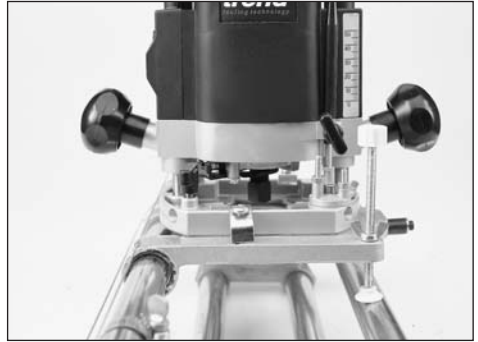

Locking the Cable Drum to the Headstock Frame

The headstock has a locking arrangement which is used to stop the cable drum rotating within the headstock. This is required when fluting and templating along the length of the component. To lock the cable drum to the headstock, engage the plate onto the rim of the cable drum and tighten the bolt with the hex key and wing nut. Check regularly to make sure the locking plate has not worked loose.

Index Pin

The index pin provides the facility to lock the drive spindle at increments of 15° for equal spacing of 2, 3, 4, 6, 8, 12 and 24 cuts around the workpiece. The pin is engaged by a twist and release action. A slight rocking action of the spindle may be required to make sure the pin has located correctly. The cable drum has four small arrows on its axis to provide an indexing facility using the numbers on the drive spindle. These numbers can be changed as required by pulling out the index pin, turning the drive spindle to the number required, then replacing the index pin.

OPERATION

Mounting the Workpiece onto the Routerlathe

The centre bushing of the tailstock should be set at its lowest position and locked in place with the hex key. The tailstock frame can be positioned anywhere along the tubes as desired - close to the headstock for short work, far away for longer work, but it must always be perpendicular to the tubes. This can be checked with a set square prior to tightening the hex bolts. Generally, if routing is to be done all the way to the tailstock end of the workpiece, leave approximately 100mm between the workpiece and the tailstock frame by winding out the tailstock spindle. Once the tailstock frame has been positioned and is perpendicular to the tubes, the four hex bolts can be tightened up.

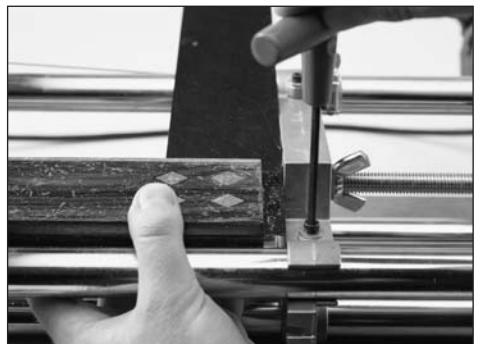

Place the workpiece in the headstock and wind out the spindle in the tailstock until it just locates in the centre hole. Wind out two more revolutions and then lock the spindle with the large wing nut. You should now be able to rotate the workpiece freely by hand.

Setting the Height of the Cutter

If using a vertical fine height adjuster with your router, swing the router on the carriage plate over the workpiece. Adjust the two feet of the carriage so that there is a small clearance between the carriage and the corner of the workpiece. Use the vertical adjuster on the router to lower the cutter until it just touches the workpiece. The lowering of the cutter when making turnings is carried out with the vertical adjuster.

If a vertical fine height adjuster is not available, swing the router on the carriage plate over the workpiece. Adjust the left foot of the carriage so that there is small clearance between the carriage and the corner of the workpiece. This will act as a bottom stop so that the router carriage will not be lowered any further than this.

The right foot is used for controlling the depth of cut. First the foot must be turned clockwise to raise the carriage away from the workpiece. How much will depend on the maximum depth of cut you wish to make, but 30mm should be sufficient. The router is then plunged until the cutter just touches the corner of the workpiece. The router should then be locked into this position. The lowering of the cutter when making turnings is carried out by unscrewing the right foot.

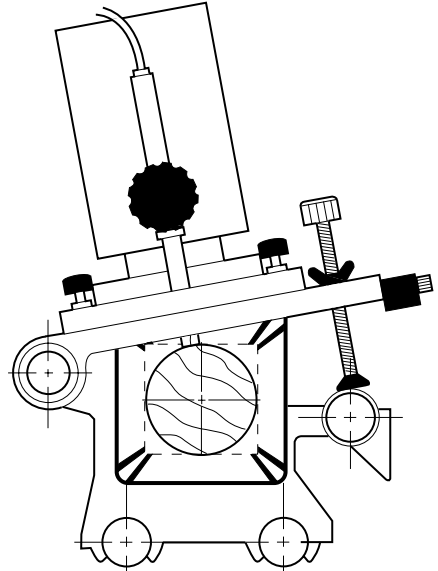

Wood Preparation

The woodpiece should be squared and cut to length. The end that is to go into the headstock should be cut square for accurate fitting.

Mark up the centre of the tailstock end by drawing diagonal lines from each corner. Then centre drill at this point, first with a standard 3mm or 4mm diameter drill bit, and then countersunk to about 6mm diameter.

Alternatively the adjustable countersink (ref. UNI/CS) can be used with a standard drill bit. The centre hole can be lubricated with wax to aid the turning motion.

To speed up the rounding-up procedure, the four corners of the woodpiece can be planed down with a hand plane, portable electric planer or surface planer, or with a bandsaw/sawbench, so that the workpiece becomes octagonal in shape. This can also be carried out with a lathe by indexing the spindle to cut the four corners lengthways prior to rounding-up.



Rounding-up

Before any type of work is carried out on the Routerlathe, the corners of the workpiece must be machined down to make a reasonably smooth cylindrical shape.

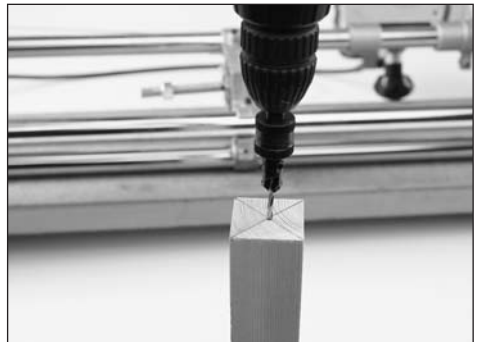

Suitable Cutters

Straight cutters (ref. 3/20 and 3/80).

The first operation for rounding-up is to reduce the square section of the workpiece to an octagonal section. This can be performed in a number of ways, as follows:-

1. With a stationary surface planing machine.
The side fence is set up at 45°, the planing depth should be set to about 2mm, then make several passes on each of the four corners until the required octagonal cross section is reached.
2. With a portable electric planer or hand plane.
Clamp workpiece and plane corners until octagonal section is reached.
3. With a bandsaw or sawbench with a 45° rip fence or jig arrangement.
4. With the Routerlathe using the procedure below and starting with the cutter (ref. 3/80).

Setting Up

- Position the carriage stops to limit the extent of the workpiece which is to be rounded up.
- Disconnect the carriage cable clamp from the cable.
- Engage index pin.
- Turn the cable drum until the spring in the cable is positioned as near to the tailstock as it will go. This is to get the spring away from the working area.
- Disengage index pin.
- Adjust the height of the router carriage and cutter.
- Slide the router carriage to the tailstock end.

Routing Procedure

- Raise the router out of the workpiece and switch on.
- Lower the router onto the first corner.
- Using a steady constant speed, pull your router along the workpiece by hand. Keep the workpiece steady by holding the handle.
- Without lifting, return the router to the tailstock end.
- Turn the workpiece through 90° anti-clockwise and machine along the next corner.
- After all four corners have been machined, lower another 3mm and repeat the process on all the new corners until a multi-sided workpiece is achieved.

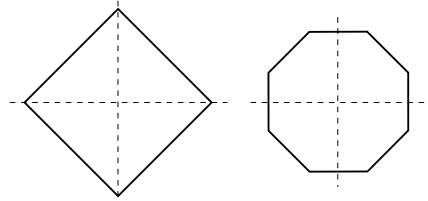

Stage 1
Square workpiece in lathe

Stage 2
Four corners are machined off

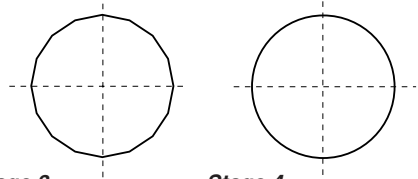

Stage 3
Repeat process until all corners have been machined off

Stage 4
Rounding up to create a smooth cylindrical shape

Rounding-up the Workpiece to a smooth cylindrical shape

- Move the router to the tailstock end.
- Switch the router on and lower the cutter about 2mm into the workpiece whilst rotating the workpiece with the handle anticlockwise.
- Whilst rotating the workpiece, gradually pull the router by hand towards the headstock until the carriage contacts the stop.

This completes the rounding of the workpiece. A second pass with a very light cut may be necessary for a smoother finish using the cutter (ref. 3/20).



Circular Beads & Coves

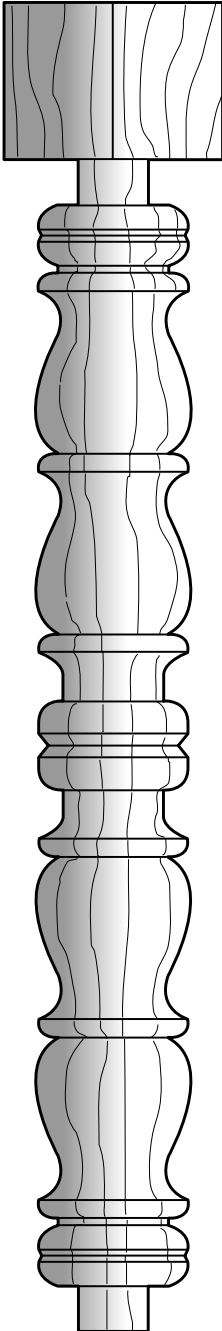

APPLICATIONS

Circular Beads & Coves

Circular beads and coves are formed by the shape of the cutter used or from a combination of cutters.

Suitable Cutters

Individual cutters shown below, also available as sets: **SET/RLxHSS** or **SET/RLxTC** with 1/4" or 8mm shanks.

Setting Up

- Lock the router carriage in one position by positioning the carriage stops each side of the carriage so that the router cutter will give the shape at the required position.
- Disengage the index pin.
- Lower the cutter until it is almost touching the workpiece.

Routing Procedure

- Switch on the router.
- Lower the cutter into the workpiece.
- Turn the workpiece with the handle until a cut has been made around the complete workpiece.
- Lower the cutter in stages whilst revolving until the required depth of cut is achieved.
- Lift the router away before turning the router off.

This type of circular cut can only be produced with a cutter having an end or plunge cut facility.

If you wish, you can position the router carriage to the right or left to make another cut to blend in with the previous cut.

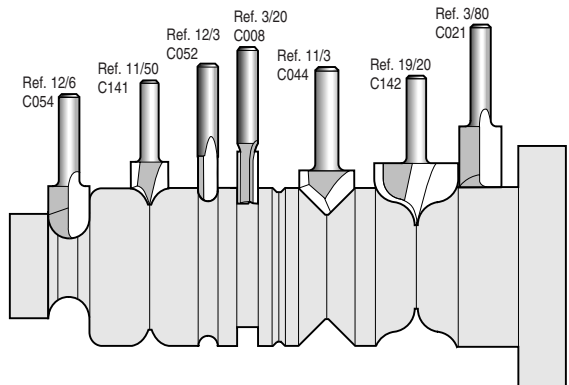

Roping & Spiralling

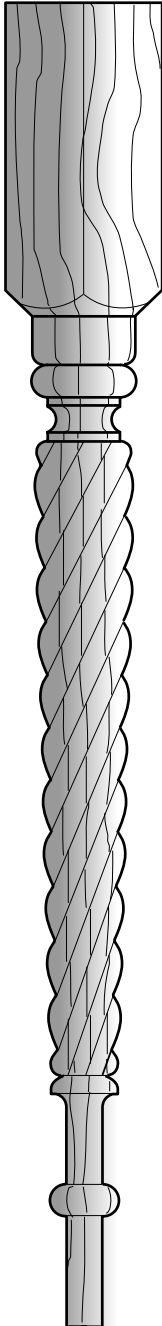

Roping & Spiralling

'Roping' or 'Spiralling' is a unique feature of the Trend Routerlathe. Spiralling is a general term and refers to any form or shape of spirals around the workpiece. You can cut right hand and left hand spirals - both to the same workpiece if you wish to produce a 'pineapple' or diamond effect. The drive spindle has 24 positions, therefore you can make your choice of 2, 3, 4, 6, 8, 12 or 24 equally spaced spirals.

The portion of the workpiece which is to be roped or spiralled should, of course, be rounded-up prior to the spiralling in order to achieve best results.



IMPORTANT!

The workpiece should not be removed from the Routerlathe after rounding-up until the roping or spiralling has been done.

Suitable Cutters

Panel cutter ref. 11/50 or C141
Panel cutter ref. 19/20 or C142
Straight cutter ref. 3/20 or C008

Setting Up

- If possible, ensure that the axis of the cutter is directly over the centre line of the workpiece. This can be adjusted by moving position of router on the carriage.
- Lower the cutter until it almost touches the workpiece.
- Set the carriage stops on the rear bar in a position to limit the length of the spiral or rope design required.
- Unlock the cable drum from the headstock.
- Attach the cable clamp to the steel lug on the cable. The lug is inserted in the recess of the cable clamp, beneath the washer and the bolt and nut tightened. There is one lug on the top cable and one on the bottom cable. Attaching the cable clamp to the lug on the top cable will produce a left hand spiral, attaching the cable clamp to the lug on the bottom cable will produce a right hand spiral.

- Adjust the cutter so that it almost touches the workpiece and move the router to the headstock end until it rests against the stop. Check to be sure that the cutter is now at the point at which you want the movement of the cutter to stop.
- With the router still lifted up slightly off the workpiece, reverse the handle direction and return the router carriage to the tailstock end. Again check to be sure that the cutter is now at the point at which you want the movement of the cutter to start.



Routing Procedure

- Set the index and engage the index pin.
- Starting at the tailstock end let the router carriage feed screw pads rest on the front bar and turn the router on.
- Lower the cutter into the workpiece approximately 2mm.
- Hold the router handle with the left hand, and with the right hand turn the handle slowly but steadily to pull the router along the workpiece towards the headstock.



IMPORTANT!

Do not stop turning the handle whilst the cutter is in the work. If for some reason you do not want to complete the cut, lift the router up off the workpiece and return it to the tailstock end. Do not turn the handle backwards with the router cutter in contact with the workpiece, as this may cause an inconsistent spiral, thus ruining the workpiece.

- After the first cut has been made and the router has been turned off, return it to the left end of the workpiece and take note of the index number.

- The second and remaining cuts are made in the same manner as the first cut. The index pin should be disengaged and the workpiece revolved to the next position. The index positions are numbered 1 through to 24; always divide the number of spirals into 24 and that will give you the start number, then simply follow the 'times table' for sequence of index points. Examples:

| Spirals required | Division | Start number on index |
|------------------|-----------------|-----------------------|
| 8 | $24 \div 8 = 3$ | 3, 6, 9, 12, 15 etc |
| 6 | $24 \div 6 = 4$ | 4, 8, 12, 16 etc |
| 4 | $24 \div 4 = 6$ | 6, 12, 18, 24 |
| 3 | $24 \div 3 = 8$ | 8, 16, 24 |



IMPORTANT!

When roping or routing spirals, always move the router from tailstock to headstock direction, otherwise an inaccurate cut will be made.

Through Spirals

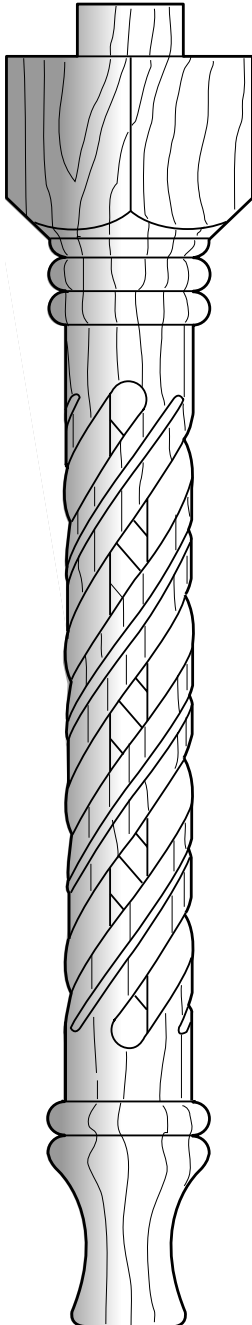

Through Spirals

Care must be taken on through spiral work as the component can become very fragile, and possible fracturing on the short grain can occur. Therefore care must be made in the selection of suitable timbers. The timber should be straight and close grained. Softwoods should be avoided.

When machining through spirals, the decorative moulds on the component should be machined first, before any attempt is made to cut right through the component.

Suitable Cutters

Ref. L140 or ref. 3/40L
Ref. 19/20 or C142

Setting Up

To allow through cuts to be made a long reach cutter must be used. The router fine height adjuster (if fitted) should be disengaged to prevent the 'kick' at the end of the spiral cut.

The Routerlathe is set up for normal spiral work, the limit stops being set to give the length of the spiral turning required.

Routing Procedure

A cutter to produce the top mould of the spiral, should be used first on the spirals, so as to give a decorative top edge to the spirals. Once all the decorative cuts have been made the through spiral can be attempted, using the long series router cutters.

Shallow passes must be made to achieve the deep grooves. At the beginning and end of each cut the router plunge should be released so that the tool comes straight out of the slot, this procedure being repeated for each subsequent cut.

When the cutter nears the centre of the axis of the component the through spiral will begin. When three or more index starting points are used, the through spiral will begin to take shape. Once the cutter passes the centre line of the component the central portion begins to bounce from the cutter rather than be cut, therefore we advise that the central core is broken up and dragged through one of the spirals. The component can be cleaned up with abrasive paper or an abrasive flap wheel.

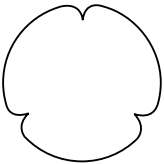

Stage 1

First cut made to give decorative top edge to spirals

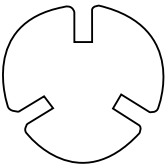

Stage 2

Make shallow passes to achieve the deep grooves until the central core is formed

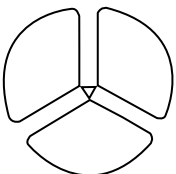

Stage 3

When break through is achieved, remove central core

Straight Beads & Flutes Cut Lengthwise

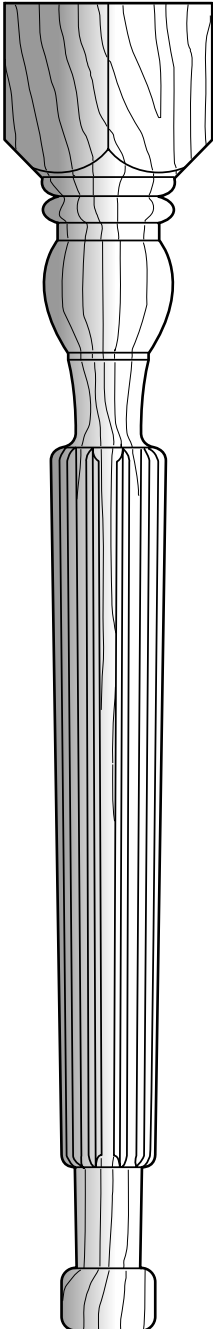

Straight Beads & Flutes cut lengthwise

Routing straight beads lengthwise and equally spaced can be done very quickly. The shape of the cutter determines the shape of the finished cut. Select the appropriate cutter for the shape of cut you require.

Suitable Cutters

- 'V' groove ref. 11/3 or C044
- Panel mould ref. 11/50 or C141
- Radius cutter ref. 12/6 or C054

Typical Designs of Straight Beads and Flutes Cut Lengthwise

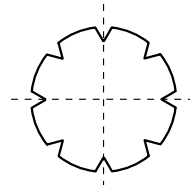

Using cutter ref. 11/3 or C044

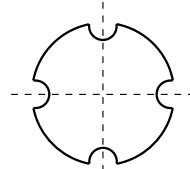

Using cutter ref. 12/6 or C054

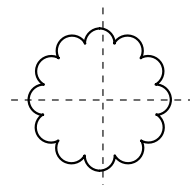

Using cutter ref. 19/20 or C142

Setting Up

- The router carriage should, where possible, be level to the machine bed. This will result in the cutter being perpendicular to the component.
- Set the index and engage the index pin
- Set the carriage stops on the rear tube in a position to limit the length of the bead of flute design required.
- Lock the cable drum to the headstock frame so that the drive spindle will not rotate.

Routing Procedure

- The first cut should be made with both hands on the router feeding from a tailstock to headstock direction at a reasonably steady speed.



IMPORTANT!

Do not stop in the middle of a cut. If for some reason it is necessary to stop, raise the router up so that the cutter bit is not in contact with the workpiece before stopping the feed of the carriage.

- When the carriage has been moved all the way to the stop, lift the router and return it to the tailstock.
- Swing down the router and lower the cutter and repeat if necessary.
- Lift the router to the tailstock end stop and switch off the router.
- The workpiece should be indexed to the next position to make the second cut. If, for example, you want twelve equally spaced cuts, the index pin positions would be 2, 4, 6, 8, 10, 12, 14, 16, 18, 20, 22 and 24.

Contour Turning

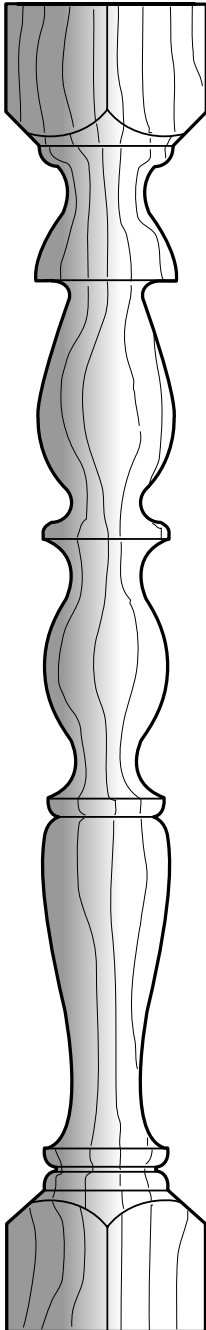

Contour Turning

When contour turning it is necessary to use a template and the template follower. One end of the template is bolted to the headstock frame and the other end to the tailstock frame using the two template mounting bolts (see page 4). When the template is fitted to the front of the lathe, the template follower will rest on the template and cause the router carriage to follow the template when it is guided along the tubes. The final depth of cut is therefore determined by the position of the end of the router bit relative to the template follower.

Template Layout and Construction

When making a template for contour turning the shape required is first drawn on paper. The vertical component of the shape must then be enlarged twice, to give the required shape in the workpiece. This is due to the cutter being positioned halfway between the pivot point of the router carriage and the template follower.

The shape is first divided into equal sections with vertical lines. The vertical measurement of each line is then doubled and this point marked. When all the points have been marked, a smooth line is drawn through the points.

Glue or tape the template layout onto the template material. The template should be made from plywood approximately 200mm wide and 100mm longer than the finished turning. The template material should be relatively rigid to avoid distortion under the weight of the router.

Saw along the layout line, file and abrade the template edge smooth. Drill two 5mm holes in the template to mount the template to the front of the Routerlathe. The distance between the holes will depend on the distance between the headstock and the tailstock, and should be measured for each particular job.

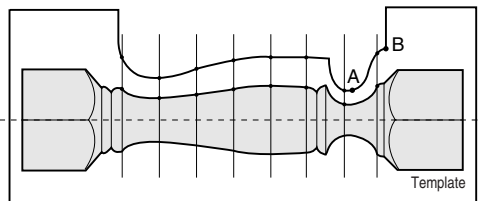

If the template is short or will be used repeatedly along the length of the turning, a different type of template should be produced. The template is constructed as above but mounted on a horizontal board which is then clamped to the bench top at the required positions along the workpiece.

A core box cutter should be used which has the same diameter as the template follower (ref.12/6). Once the workpiece has been rounded-up, the template must be fitted parallel to the tubes.

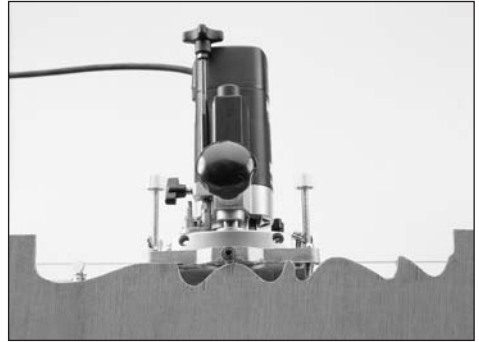

Setting Up

- Rotate the cable drum until the spring in the cable is as close the tailstock as possible.
- Lock the cable drum to the headstock frame by tightening the wing nut.
- Disengage the index pin to disconnect the drive spindle from the cable drum.
- Rest the template follower on the lowest part of the template (point A). The feet of the carriage may need retracting so that they do not touch the front bar.
- Use the fine height adjuster on the router to lower the cutter until it almost touches the workpiece.

Routing Procedure

The cutting of the workpiece is carried out in stages.

- The router is switched on and the cutter lowered into the workpiece 2mm to 3mm.
- The workpiece is then turned steadily with moderate speed whilst the router is guided by your other hand along the template. Initially, material will only be removed at the highest points on the template, but as each run is done and the cutter lowered another 2mm-3mm, more of the template will start to appear in the workpiece. The handle must be turned anti-clockwise.

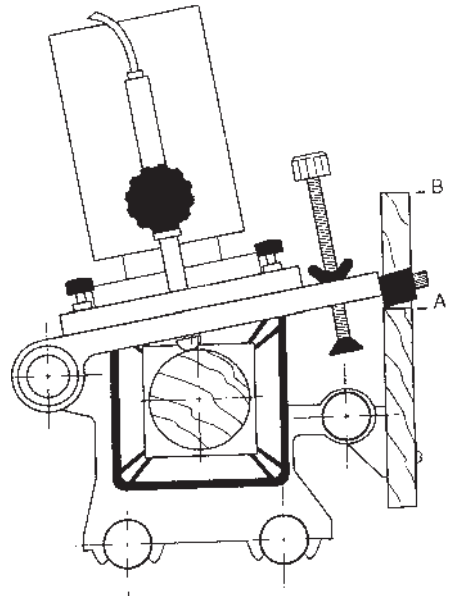

Tapered Turning

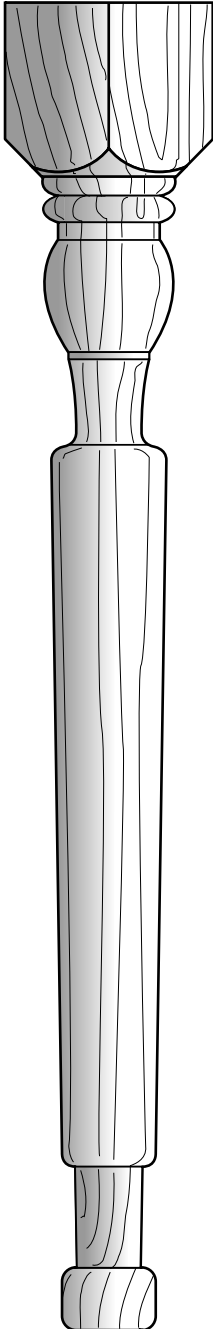

Tapered Turning

Tapered turnings can be described by the turning having a gentle slope or tapered effect. Taper turnings can be used in conjunction with other types of turning.

On the tailstock there are five graduation marks giving one 12mm offset which will result in a 24mm taper over the full length of the workpiece. With the top edge of the centre bushing on the lowest mark, the centre screw would be approximately in line with the centre of the headstock.

Turning at this setting would have zero taper (a straight turning). Positioning the centre bushing over the second mark would raise the centre screw 3mm above the centre of the headstock, thus producing a taper of 6mm over the length of the workpiece.

It should be noted that the indicated amount of taper on the scale is for the distance from the tailstock to the headstock. This distance is greater than the tapered length of the workpiece and so the resultant taper will be slightly less than shown on the graduation mark setting.

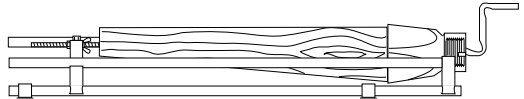

Recommended Cutters

Straight cutters refs. 3/20, 3/80 or C008

Setting Up

- With a rounded workpiece in the Routerlathe, loosen the wing nut of the tailstock and then loosen the hex socket bolt with the hex key provided.
- Move the centre bushing up to achieve the required taper. Tighten the wing nut and hex socket bolt of the tailstock.

Routing Procedure

This is the same as for the 'Rounding-up' operation

If a rope or straight flute is to be put on a tapered section, the centre bushing must remain on the same setting used for the taper. If the workpiece is to have circular beads or coves, then these should be cut with the centre bushing set on the lowest mark.



Guarantee

- The machine carries a manufacturers guarantee in accordance with the conditions on the enclosed guarantee registration card.

Recycling

- Machine, accessories and packaging should be sorted for environmentally friendly recycling.

EXAMPLES

Turnings with Template Shapes

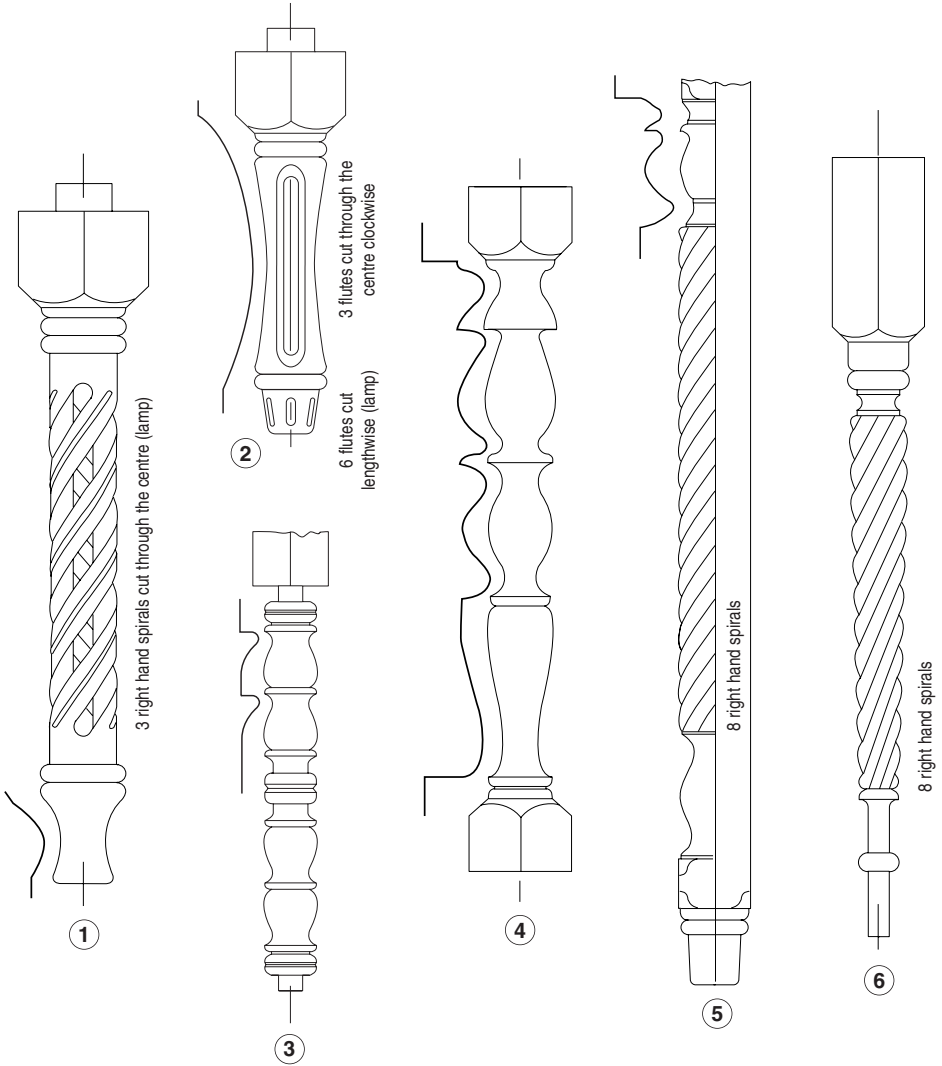

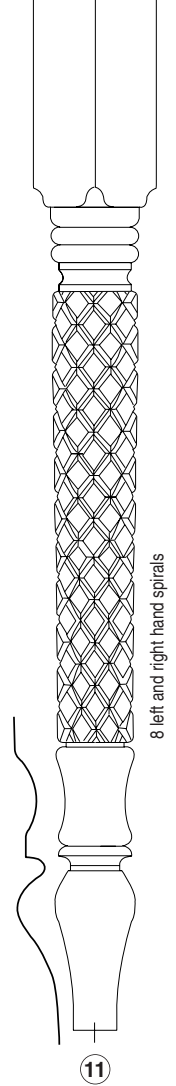
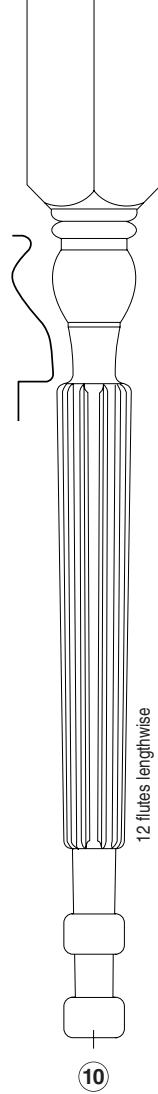
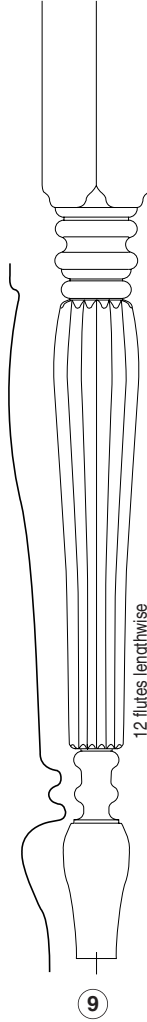
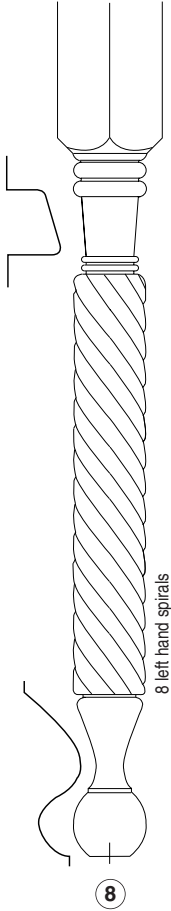
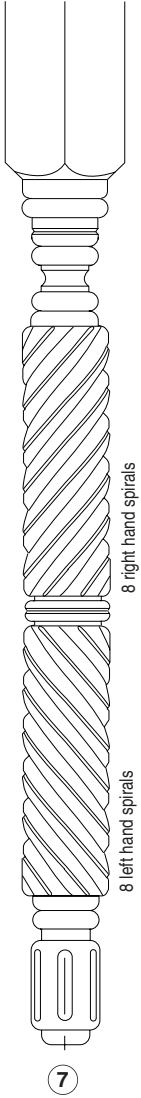

| ROUTERLATHE - SPARE PARTS LIST | | | v3.0 01/2000 |
|---------------------------------------|------------|-----------------------------------------|---------------------|
| Item | Qty | Description | Ref. |
| 1 | 1 | Handle | WP-RL/01 |
| 2 | 1 | Lock Ring | WP-RL/02 |
| 3 | 1 | Lock Ring | WP-RL/03 |
| 4 | 1 | Push Nut | WP-RL/04 |
| 5 | 1 | Index Pin Knob | WP-RL/05 |
| 6 | 1 | Headstock | WP-RL/06 |
| 7 | 4 | Grub Screw UNF 10 - 32 x 1/4" | WP-RL/07 |
| 8 | 1 | Wing Nut UNC 10 - 24 (Nylon Insert) | WP-RL/08 |
| 9 | 1 | Cable Drum Clamp | WP-RL/09 |
| 10 | 5 | Machine Screw Socket UNC 10-24 x 1 1/2" | WP-RL/10 |
| 11 | 4 | Retaining Ring | WP-RL/11 |
| 12 | 1 | One Inch Pulley | WP-RL/12 |
| 13 | 1 | Double Pulley Shaft | WP-RL/13 |
| 14 | 2 | Adjustable Stops | WP-RL/14 |
| 15 | 2 | Two Inch Pulley | WP-RL/15 |
| 16 | 1 | Spring | WP-RL/16 |
| 17 | 1 | Index Pin | WP-RL/17 |
| 18 | 1 | Drive Spindle | WP-RL/18 |
| 19 | 1 | Roll Pin 1/8" x 5/8" | WP-RL/19 |
| 20 | 1 | Cable Drum | WP-RL/20 |
| 21 | 7 | Washer 7.3mm x 16mm x 1.5mm | WP-RL/21 |
| 22 | 4 | Conduit Clamp 3/4" | WP-RL/22 |
| 23 | 4 | Machine Screw Square UNC 1/4"-20 x 1" | WP-RL/23 |
| 24 | 4 | Clamp Nut | WP-RL/24 |
| 25 | 2 | Screw Knob | WP-RL/25 |
| 26 | 2 | Nyliner Bearing | WP-RL/26 |
| 27 | 1 | Machine Screw Socket UNC 10-24 x 3/4" | WP-RL/27 |
| 28 | 11 | Washer 5.6mm x 12.5mm x 1.2mm | WP-RL/28 |
| 29 | 1 | Cable Clamp | WP-RL/29 |
| 30 | 1 | Stop Nut UNC 10 - 24 | WP-RL/30 |
| 31 | 1 | Retaining Ring | WP-RL/31 |
| 32 | 1 | Hex Key 5/32" A/F | WP-RL/32 |
| 33 | 1 | Router Carriage | WP-RL/33 |
| 34 | 2 | Wing Nut UNC 1/4" - 20 | WP-RL/34 |
| 35 | 2 | Screw Self Tapping UNC 10-24 Type F | WP-RL/35 |
| 36 | 2 | Adjusting Screw | WP-RL/36 |
| 37 | 2 | Rest Pad | WP-RL/37 |
| 38 | 1 | Bushing for Follower | WP-RL/38 |
| 39 | 6 | Nut Square 10 | WP-RL/39 |
| 40 | 2 | Machine Screw Socket UNC 10-24 x1" | WP-RL/40 |
| 41 | 1 | Spring Ext. | WP-RL/41 |
| 42 | 1 | Cable Assembly | WP-RL/42 |
| 43 | 1 | Single Pulley Shaft | WP-RL/43 |
| 44 | 1 | Pulley Tube | WP-RL/44 |

| ROUTERLATHE - SPARE PARTS LIST | | | v3.0 01/2000 |
|---------------------------------------|------------|----------------------------------|---------------------|
| Item | Qty | Description | Ref. |
| 45 | 1 | Wing Nut UNC 1/2" - 13 | WP-RL/45 |
| 46 | 1 | Washer 13.3mm x 27mm x 2.5mm | WP-RL/46 |
| 47 | 1 | Tailstock | WP-RL/47 |
| 48 | 1 | Grooved Pin 3/16" x 5/8" Type D | WP-RL/48 |
| 49 | 1 | Centre Bushing | WP-RL/49 |
| 50 | 1 | Centre Screw | WP-RL/50 |
| 51 | 1 | Nut Hex UNC 1/2" - 13 | WP-RL/51 |
| 52 | 3 | Frame Tube | WP-RL/52 |
| 56 | 2 | Machine Screw Pan M6 x 30mm slot | WP-RL/56 |
| 57 | 2 | Router Clamp Plate | WP-RL/57 |
| 58 | 2 | Washer 6.5mm x 19mm x 1.0mm | WP-RL/58 |
| 59 | 2 | Nut Hex M6 | WP-RL/59 |
| 60 | 4 | Plug for Frame Tube | WP-RL/60 |
| 61 | 2 | Machine Screw Pan M5 x 16mm slot | WP-RL/61 |
| 62 | 2 | Nut Hex M5 | WP-RL/62 |
| 63 | 1 | Manual | MANU/RL |
| RL/DC | | | |
| 64 | 1 | Drive Centre Holder | WP-RLDC/01 |
| 65 | 1 | Drive Centre Insert | WP-RLDC/02 |
| 66 | 1 | External Ring 1" ID | WP-RLDC/03 |
| 67 | 1 | Instruction Leaflet RL/DC | INST/RL/DC |

ROUTERLATHE SPARE PARTS DIAGRAM

v3.0 01/2000

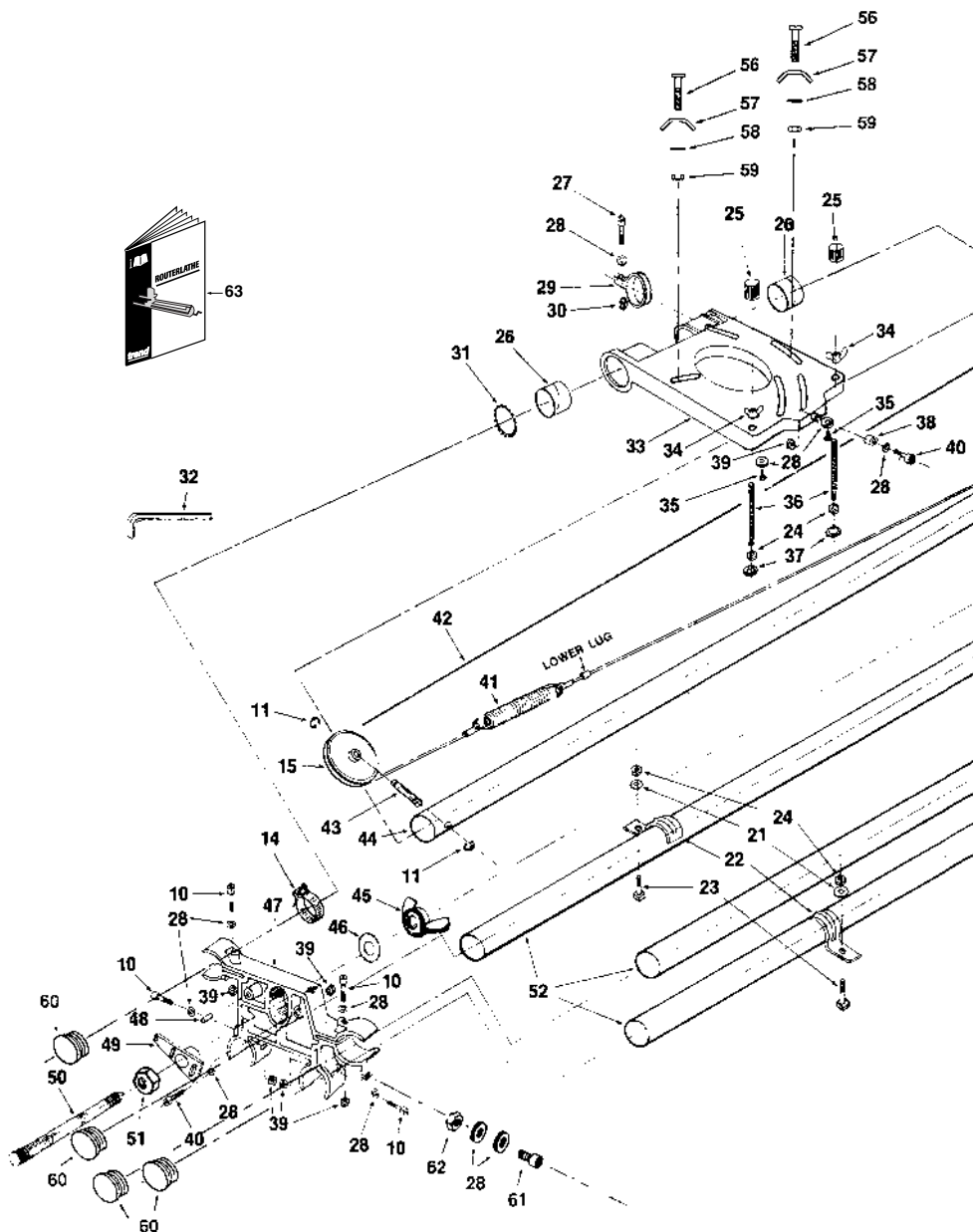

v3.0 01/2000

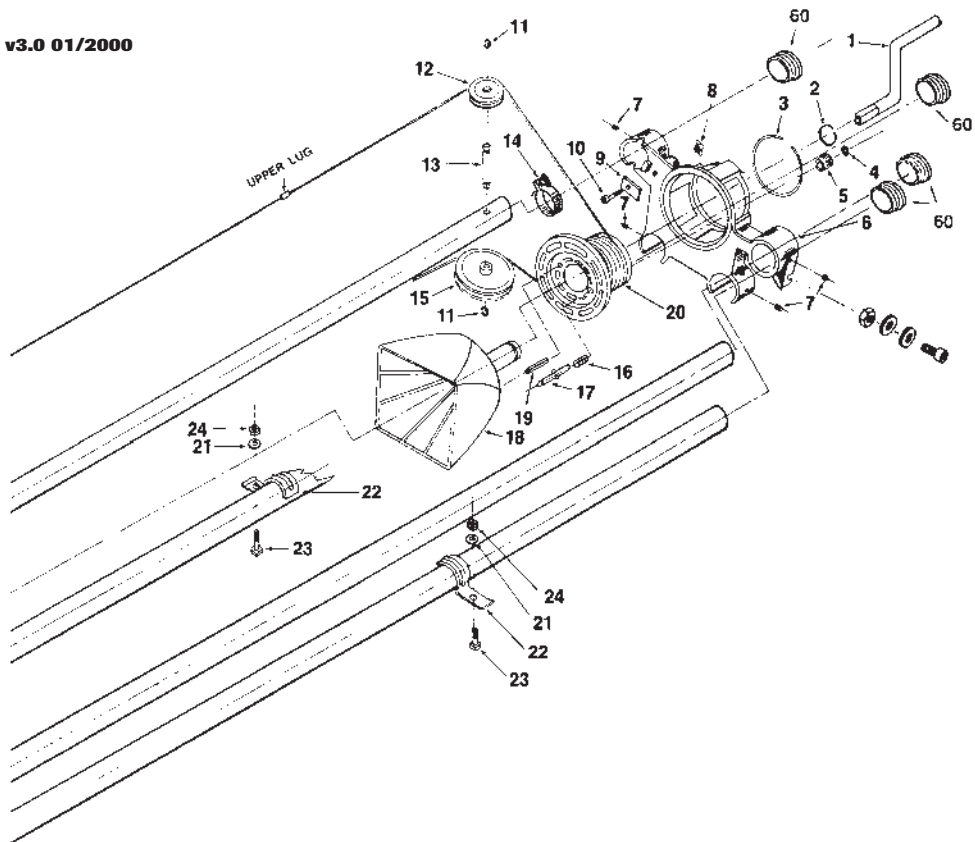

RL/DC

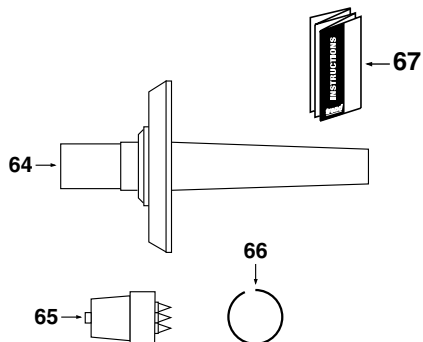

MANU/RL v3.0



RECYCLABLE

Trend Machinery & Cutting Tools Ltd.

Odhams Trading Estate St Albans Road
Watford WD24 7TR England

Tel: 0044(0)1923 249911
technical@trendm.co.uk

www.trend-uk.com