

Precision Combination Chuck Manual



Robert Sorby Ltd.

INTRODUCTION

The Precision Combination Chuck is the result of six years of research and development to produce a chuck which is really accurate, versatile, time saving and good value for money.

We feel we have succeeded in producing the ultimate in holding devices for the woodturning lathe.

However, its basic design does not preclude the future development of other accessories. This is illustrated by our latest innovation – a 3 and 4 jaw chuck assembly which is detailed on page 12.

The Precision Combination Chuck, made on computer controlled machines, is extremely accurate and all parts are completely interchangeable from one chuck to another.

The user can therefore add components as the need arises.

Such accuracy eliminates the problems of centricity which have long plagued the turner especially when returning work to the lathe.

It is quick and easy to use and has up to $\frac{1}{4}$ " adjustment on all the expanding dovetail collets.

There are no protruding parts which might otherwise cause injury to the hand or damage the tool.

The absence of fixing screws removes the danger of accidentally damaging the tools. All surfaces, including the base, can be turned and finished at one setting.

COMPONENTS OF BASIC PRECISION COMBINATION CHUCKS

In its BASIC form the Precision Combination Chuck offers most woodturners adequate solutions to their various holding problems.

N.B. From October 1987 the BASIC chuck will be supplied with additional 1 3/4" & 2 1/2" expanding dovetail collets No. 905. This gives facility for a much wider range of sizes to be turned and the provision of THREE SIZES allows greater freedom of design.

The components and accessories, illustrated here, are supplied as standard with the BASIC chuck. However, in some countries, standard accessories may vary – in which case the supplier's literature should indicate the variation/s.

An extensive range of optional accessories gives additional sophistication required by the serious amateur and professional turner.

For details of each chuck mode please refer to the following pages:

BASIC CHUCK INCLUDES:



	PAGE
EXPANDING DOVETAIL COLLETS	3 & 4
3-WAY SPLIT RINGS	5
PIN CHUCKS	6
COLLAR CHUCK	7
CUP CHUCK	8
SCREW CHUCKS	9
SPIGOT/COLLET CHUCK	10
ADJUSTABLE COLLET CHUCKS	11
3 & 4 JAW CHUCK ACCESSORIES	12
FACEPLATE RINGS	13

EXPANDING DOVETAIL COLLETS

USE: BODY, SCREWED COLLAR, CENTRE BOSS, & 1 3/4", 2 1/2" or 3 1/2" EXPANDING DOVETAIL COLLETS

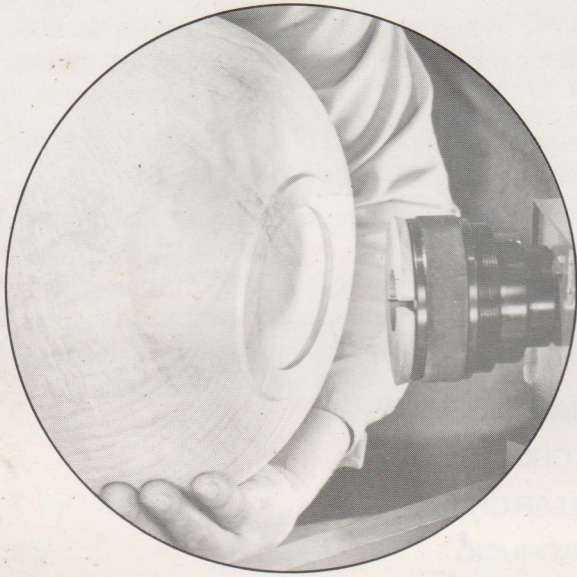

This is, for the majority of woodturners, the most important mode of the Precision Combination Chuck. The collets, which are either cast or machined steel, have an angled edge which grip inside a dovetailed recess cut in the timber.

This provides the safest known method of holding work on the lathe without the aid of screws.

A variety of sizes of collets offers a capacity range of between 7/8" & 3 3/4".

In effect this means that any block within the capacity of most woodturning lathes can be accommodated safely.

TIMBER PREPARATION

Cut the timber to round or remove the corners.

The disk may then be held by means of:

- i) Faceplate as normally supplied with your lathe.
- ii) Faceplate ring see p.13
- iii) Screw Chuck see p. 9
- iv) Pin Chuck see p. 6

The outside of the bowl may now be turned. Incorporate in the design a suitable dovetailed recess for the appropriate diameter of collets.

The collets will, on average, allow up to 1/4" adjustment and the diameter of the recess is therefore not critical. The depth of recess need not be more than 3/16". The dovetailed undercut can be produced with a skew scraper or long point of a skew chisel used on its side.

After turning the outside, the bowl can be removed from the lathe and is now ready for mounting on the expanding dovetail collets to turn the inside.

ADDITIONAL EXPANDING DOVETAIL COLLETS No. 905

7/8" & 1 1/8" MINIATURE COLLET SET + SMALL CENTRE BOSS (see opposite).

Collet sizes: 2" 2 1/4" (steel), 2 3/4", 3" (steel), 3 3/4"

ASSEMBLY – With the chuck assembled as illustrated, and fitted with the appropriate size of collets, place the recess over the collets. Push the bowl firmly against the collets whilst tightening the collar by hand – this will expand the collets. Finally tighten with the ‘C’ spanners to give a perfectly snug fit. Turn and finish the inside.

To remove, slacken with ‘C’ spanners – finally unscrewing by hand so that the bowl may be supported with one hand.

As the collet is unscrewed the elastic band will close the collets sufficiently to withdraw the bowl. Whilst the use of an elastic band may appear to be somewhat crude it is nevertheless effective, simple and universally available. In the event of loss or breakage you are unlikely to have your chuck inoperative for more than a few minutes!

CAUTION – On soft timbers the collar may require further tightening as collets bed themselves in.

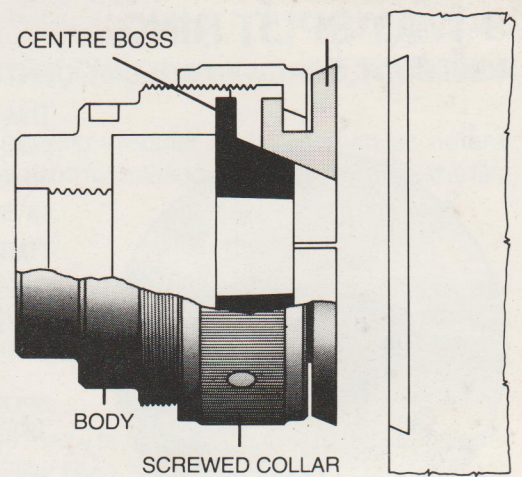

MINIATURE COLLET SET



These $\frac{7}{8}$ " & $1\frac{1}{8}$ " collets are particularly useful for holding small work. The standard centre boss is too large to expand these and therefore a mini-centre boss must be used. This is held in reversed centre boss by means of No. 3 stub morse taper, allen screw and washer.

Kit comprises:- **No. 905** - $\frac{7}{8}$ " & $1\frac{1}{8}$ " collets.
No. 900 MCB - Mini centre boss.

3-WAY SPLIT RING

USE: BODY, SCREWED COLLAR, CENTRE BOSS (Reversed) & 1 3/4" 3-WAY SPLIT RING

This mode provides the facility for holding long pieces of timber without the aid of tailstock support when turning goblets, egg cups, boxes, etc. The split rings, in effect, replace the cut flange in the Collar Chuck mode (see p.7) and results in a saving of timber.

TIMBER PREPARATION. Turn a suitable piece of timber, between centres, to a diameter of 2 1/2".

Square up the left hand end and cut a groove to the sizes shown in the illustration. Diameter B should always be the same as the internal diameter of the split rings.

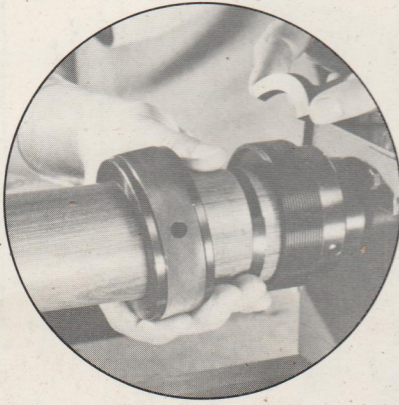

SPLIT RING BORE DIA.	A Ø	B Ø
1 1/4"	2"	1 1/4"
1 1/2"	2 1/4"	1 1/2"
● 1 3/4"	2 1/2"	1 3/4"

● BASIC COMPONENT

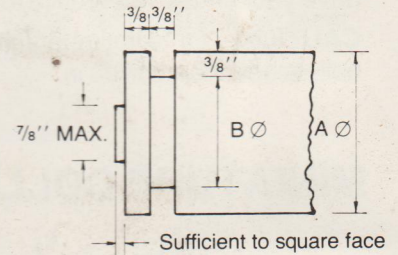

ASSEMBLY. Remove timber from between centres and insert the split rings into the cut groove. Pass the work through the collar so that the sloping face of the split rings abut the internal sloping face of the collar. Reverse the centre boss and locate in chuck body. Offer up the collar with the workpiece and screw down by hand.

Finally tighten using the 'C' spanners.

Larger diameter work can be held but a spigot must be turned of sufficient length to permit the insertion of the split rings. This can be wasteful of timber and you are advised to consider the use of expanding collet mode or spigot mode.

ADDITIONAL 3-WAY SPLIT RINGS No. 910

1 1/4" bore diameter. 1 1/2" bore diameter.

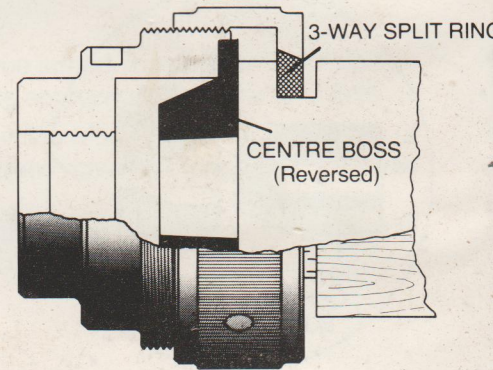

PIN CHUCK

USE: BODY, SCREWED COLLAR, CENTRE BOSS (Reversed) with 1" PIN CHUCK secured with WASHER & SCREW

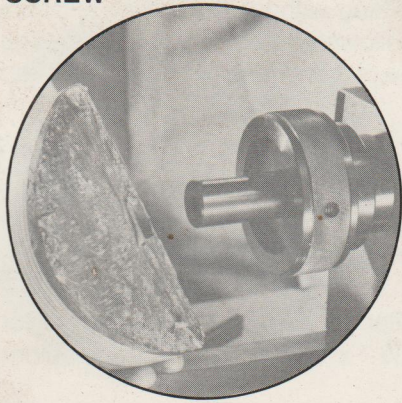

This is a particularly useful mode for holding irregular surfaces such as natural edged bowls as illustrated. It can also be used for holding other pre-bored items like serviette rings, pepper mills, etc.

TIMBER PREPARATION

All that is required is the boring of a 1" diameter hole, preferably with a suitable saw tooth cutter. When using alternative sizes use a corresponding diameter bit. The depth of hole should be sufficient to allow full penetration of the pin chuck.

ASSEMBLY

The pin chuck is secured by means of the screw and washer in the No. 3 morse taper hole in the reversed centre boss. The Filler Ring is not an essential item but does provide a flush face with the collar.

Rotate the chuck so that the flat portion of the pin chuck is in the horizontal position. Place the roller pin in the neutral position before pushing home the prepared block. The roller pin will automatically assume the locking position when the lathe is switched on.

To remove the work, stop the lathe, secure the chuck against rotation and continue to rotate the workpiece by hand in the same direction to return the roller pin to the neutral position. The pin chuck can be used for either inboard or outboard applications.

If the roller pins become lost simply cut a suitable diameter nail to length.

ADDITIONAL PIN CHUCKS No. 920

5/8", 3/4", 1 1/2", 1 3/4" size (with 1 7/8" dia. shank for use with spigot chuck No. 930 **ONLY** see p.10).

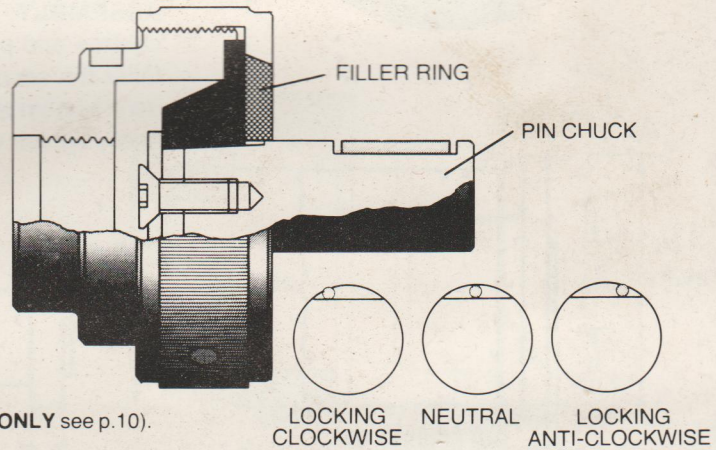

COLLAR CHUCK

USE: BODY, SCREWED COLLAR, CENTRE BOSS (Reversed)

Designed to hold long pieces of timber for working without the aid of tailstock support. This is particularly useful when turning hollowed ware such as goblets, egg cups, serviette rings and similar work where some of the turning or boring is carried out at the right hand end of the workpiece.

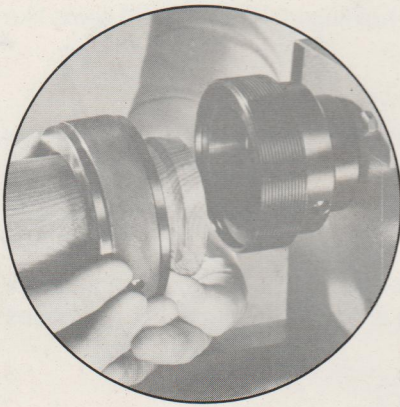

TIMBER PREPARATION

Turn a suitable piece of timber, between centres, to a diameter of $2\frac{3}{4}$ ". This diameter is not critical but should not be less than $2\frac{3}{4}$ ". Square off left hand end and produce a flange as indicated. The remainder of the length should be turned down to slightly under $2\frac{1}{2}$ " diameter.

The collar chuck may also be used to hold smaller diameters by utilising the filler ring. In which case the flange can be turned to $1\frac{1}{2}$ " x $\frac{5}{16}$ " with a square shoulder reducing the remaining material to 1" diameter.

ASSEMBLY. Remove timber from between centres and pass the work through the collar. Offer the assembly to the chuck body with the centre boss reversed. Screw down by hand and finally tighten with the aid of 'C' spanners.

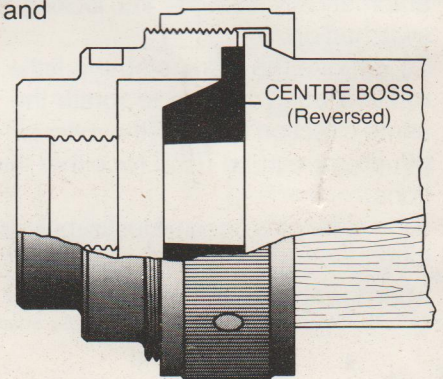
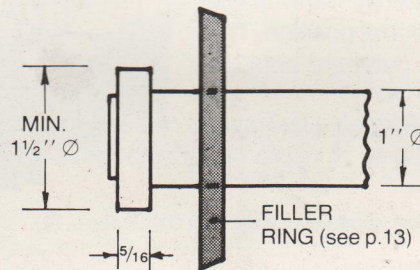
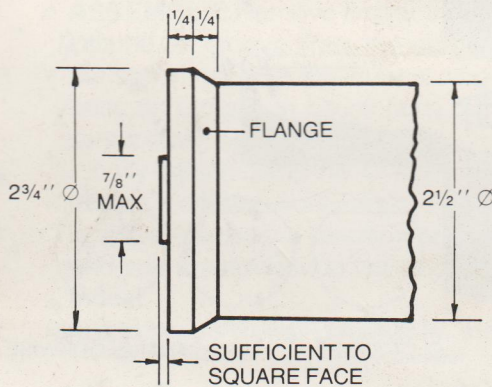

CUP CHUCK

USE: BODY ONLY

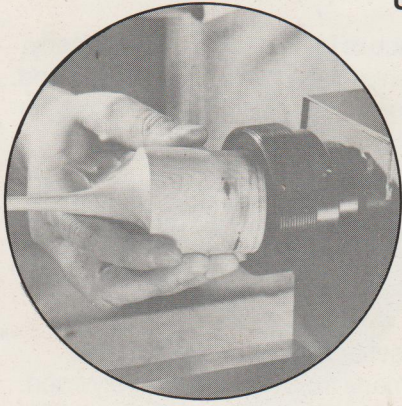

The body recess is accurately machined to house various components. This recess offers an added bonus as a cup chuck to hold partly turned work by means of a small spigot.

TIMBER PREPARATION

Timber turned to $2\frac{1}{8}$ " diameter or larger diameters with spigot turned to $2\frac{1}{8}$ " dia. x 1" long can be pushed into the body recess of the chuck.

N.B. The fit must be good and offer a slight interference. If hammering is necessary this should be carried out at the bench to avoid any possible damage to the spindle bearings on the lathe.

CAUTION

When using cup chucks always keep the tool rest as close as possible. Should the work move, the rest will prevent the job from moving out.

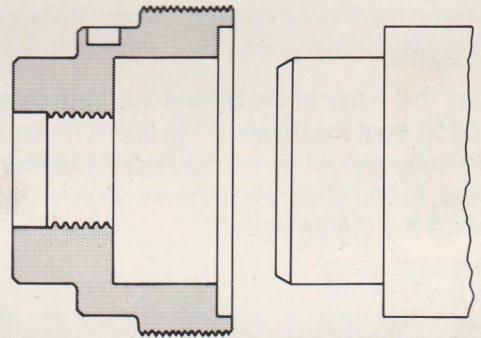

SCREW CHUCK

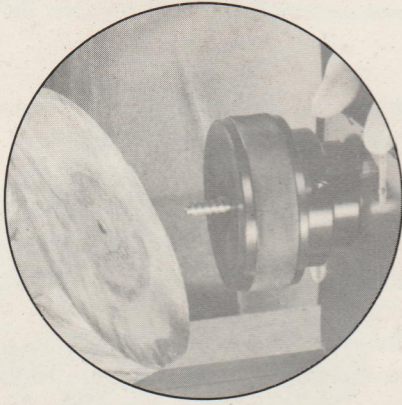

USE: BODY, SCREWED COLLAR, CENTRE BOSS (Reversed) with SCREW CHUCK secured with WASHER & SCREW

The screw chuck is arguably the most versatile piece of lathe equipment. Formerly, screw chucks used a wood screw but the screw in this chuck has a parallel core and a fine knife-like thread. It winds easily into the timber giving a very strong fixing. The job can be removed and replaced without loss of concentricity or strength.

TIMBER PREPARATION

Drill a pilot hole at the centre of the workpiece as detailed below. Do not use a pilot drill which is too small otherwise damage to the thread may result.

Wherever possible provide a flat face to abut the face of the chuck to ensure maximum drive.

The filler ring should be used to provide adequate seating for small size blocks.

If the screw should be too long its effective length can be reduced by using spacing discs made from hardwood or plywood. The centre hole should be slightly oversize to accommodate any throw up around the hole in the workpiece. Additional filler rings could also be used, but these are best used on the inside.

CAUTION. To avoid undue strain on the screw we recommend a length to diameter ratio of 3:1 i.e. a piece of wood 2" diameter must not exceed 6" long. The length may be increased if the tailstock is used for support.

ASSEMBLY

Insert the body of the screw into the centre boss – it can only be inserted from the reverse side and is retained with screw and washer. If difficulty should be experienced in removing screw chuck from the centre boss, undo allen screw slightly and tap the head lightly to release the morse taper fit.

AVAILABLE SIZES:

Mild Steel - No. 925

3/8" x 1" Right Hand (use 1/4" pilot drill)

3/8" x 1 1/4" Left Hand (use 1/4" pilot drill)

5/16" x 3/4" Right hand (use 7/32" pilot drill)

Stainless Steel - No. 925S

3/8" x 1" Right Hand (use 1/4" pilot drill)

3/8" x 1 1/4" Left Hand (use 1/4" pilot drill)

5/16" x 3/4" Right hand (use 7/32" pilot drill)

All the above screw chucks are 1/4" longer to allow for the thickness of the Outer ring or Filler ring.

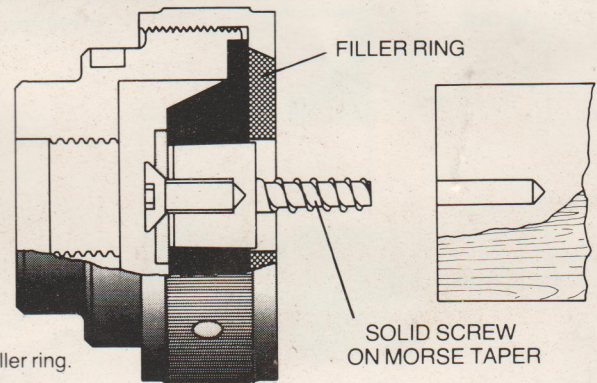

2'' SPIGOT - 1⁷/₈'' COLLET CHUCK

USE: BODY, SCREWED COLLAR 2'' SPIGOT

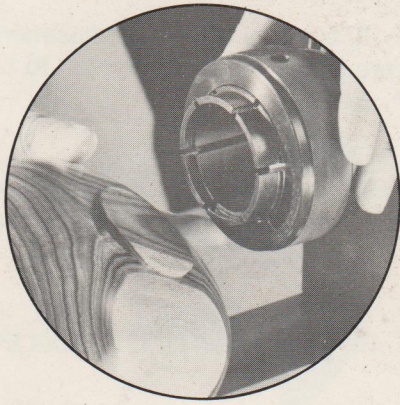

The Spigot Collet Chuck offers two different methods of holding. It offers a one operation turning after a dovetail spigot or longer parallel spigot has been cut.

The turned spigots can be removed after the job is complete and the base sanded. Alternatively the spigot can be incorporated as a design feature.

TIMBER PREPARATION

There are a number of options:-

The work may be held initially between centres, on a pin chuck, screw chuck or face-plate ring. Use the method best suited to the diameter and length of the workpiece. The choice of dovetail or parallel spigot will usually be dictated by the size or design of the item.

The diameters of the spigots must be turned accurately – an undersized spigot will allow the collet to be compressed beyond its optimum diameter and may result in permanent distortion.

ASSEMBLY

The Spigot Chuck fits directly into the chuck body and is retained and adjusted with the collar. Insert the prepared spigot and tighten by hand, finally with 'C' spanners.

CAUTION DO NOT OVERTIGHTEN THE STEEL COLLET

The collet is made in slender form so that it is flexible and will contract easily. Overtightening may cause permanent damage.

It is suggested that the purchase of a 1³/₄'' Pin Chuck would not only provide a useful accessory but that its 1⁷/₈'' diameter shaft can be used to maintain the correct diameter of the collet when not in use. (see p.6).

AVAILABLE SIZE No. 930. 2'' Spigot/1⁷/₈'' Collet.

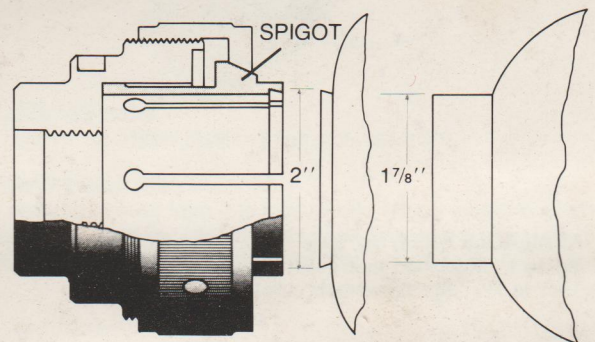

ADJUSTABLE COLLET CHUCKS

USE: BODY, SCREWED COLLAR, COLLET CONVERSION KIT, ADJUSTABLE COLLET

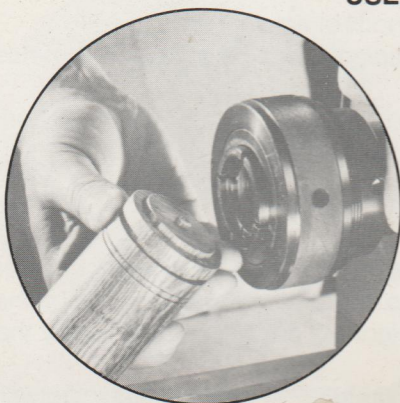

Similar holding device to Spigot/Collet chuck (p.10) but jaws offer 1/4'' adjustment on both sizes. They have the facility for holding pre-turned material from 3/4'' to 1'' and 1 1/4'' to 1 1/2'' diameter.

TIMBER PREPARATION

Similar to preparation for Spigot/Collet chuck but sized accordingly. Diameters are not so critical since the spring-loaded jaws allow a full 1/4'' tolerance between the top and bottom limits.

ASSEMBLY

No. 935 ADJUSTABLE COLLETS **CANNOT BE USED WITHOUT COLLET CONVERSION KIT No. 936.**

The female centre boss fits directly into chuck body and converts the chuck to a compression mode. Adjustment is obtained by means of collar and reducing ring. Interchangability of collets is quickly achieved.

AVAILABLE SIZES No. 935
3/4'' to 1'' Machined steel collet
1 1/4'' to 1 1/2'' Machined steel collet

COLLET CONVERSION KIT No. 936
Includes Female Centre Boss and Reducing Ring.

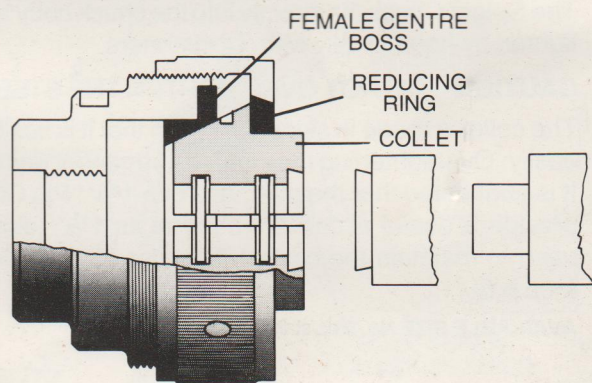

3 JAW & 4 JAW CHUCK ACCESSORIES

USE: BODY, SCREWED COLLAR, 3-JAW OR 4-JAW CHUCK ASSEMBLY

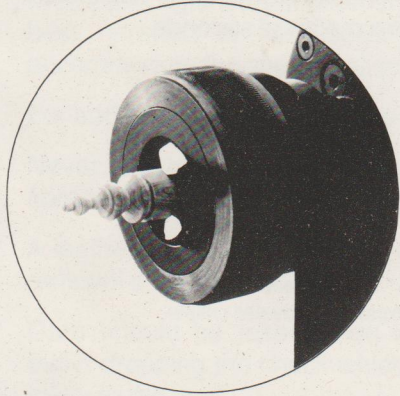

For some time we have been aware of the need to provide users of our Precision Combination Chuck with a facility to hold smaller diameter work. We are now proud to announce exciting new accessories based on the ever popular 3 jaw chuck but at a very realistic price.

The jaws grip onto spigots up to 1" long.

Easily assembled and dismantled in seconds.

No extra items required for using in chucks. Fits directly in chuck body.

AVAILABLE SIZES:

No. 937 (3 Jaw)

1/8" to 7/8" diameter - fully adjustable.

No. 938 (4-Jaw)

3/16" to 7/8" square - fully adjustable.

BEFORE INSERTING ASSEMBLY INTO CHUCK BODY, PUSH ALL JAWS TOWARDS THE CENTRE, PRESS TOP PLATE DOWNWARDS AND REMOVE ELASTIC BAND. REPLACEMENT OF THE ELASTIC BAND ON REMOVAL WILL KEEP THE SPRINGS UNDER SLIGHT COMPRESSION AND REDUCE THE RISK OF LOST COMPONENTS.

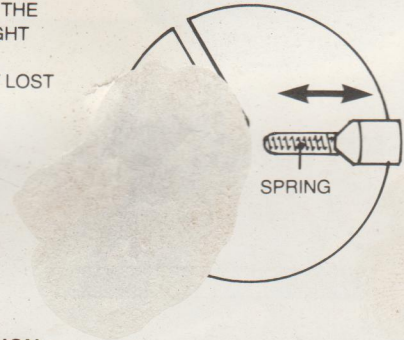
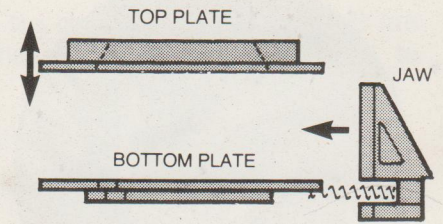

4-JAW VERSION

As above but bottom plate has four slots set at 90°.

CONVERSION KIT - No. 937C.

In order to convert from 3 to 4-jaw mode, a kit is available which comprises bottom plate (4 slots), jaw and spring. This offers greater versatility for the minimum outlay.

FACE PLATE RINGS

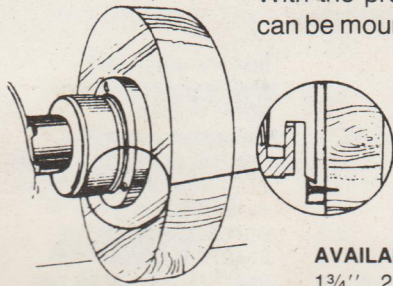
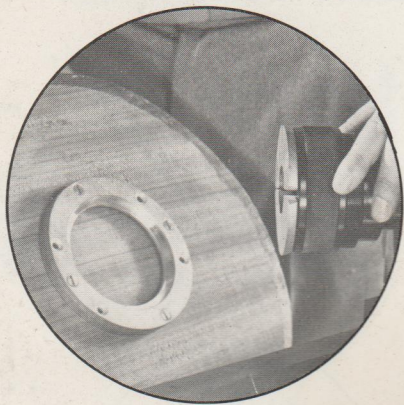

Exceptionally useful for batch production and for use in education where faceplates may be tied up for several weeks.

With the precision combination chuck on the lathe, the blocks can be mounted and removed in a matter of seconds.

AVAILABLE SIZES No. 940

1³/₄" , 2" , 2¹/₂" , 2³/₄" , 3¹/₂" / 3³/₄" (double recess)

For use with appropriate size of expanding dovetail collets.

FILLER RING

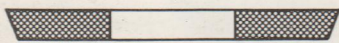

Available for use with screw chucks and pin chucks.

This component is not essential but provides a flush surface on the face of the chuck.

SPARE CENTRE BOSS, WASHER & ALLEN SCREW

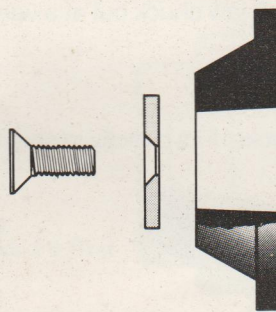

Allows for quick change over from screw chuck to pin chuck without the necessity of unscrewing the retaining screw.

CARE & MAINTENANCE

The Precision Combination Chuck is of robust construction and therefore little maintenance should be necessary other than occasional light oiling of the screw threads but protect all threaded parts against possible damage.

Protection against rust is provided by the chemical black finish but when not in use the chuck and its components are best returned to their polystyrene container. The polystyrene compartments have been carefully designed to accommodate the chuck and an extensive range of accessories.

For added protection a purpose made metal case is available, as illustrated, to complete an ideal storage system.

Never use extensions to increase leverage on the 'C' spanners – this will cause overtightening which may distort a component and will most likely damage the workpiece.

A leather or fibre washer fitted over the spindle of the lathe will ease removal of the chuck.

Care should be taken when removing or replacing the chuck to avoid dropping the chuck which may cause damage to the chuck or injury to the user.

The Precision Combination Chuck is the woodturners best friend – look after it and it will give many years of trouble free service.

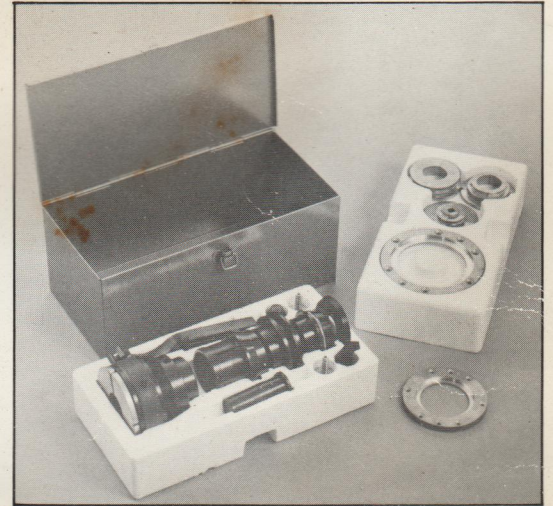

METAL CASE No. 900 MC
POLYSTYRENE PACK No. 900PP



Robert Sorby Ltd.

ATHOL ROAD – WOODSEATS ROAD – SHEFFIELD S8 0PA – ENGLAND

Telephone:
(0742) 554231
Fax: (0742) 500675

Registered in England No. 1951922

Telex:
665064 - Craft G
Ref. PCC/M/88